















































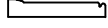

































































Panel Mold

CUSTOM PROFILE TABLE OF CONTENTS

PROFILE	SIZE	PAGE	PROFILE	SIZE	PAGE	PROFILE	SIZE	PAGE
KL 501	.375 x .625	1	KL 554	1.000 x .875	2	KL 592	.437 x .750	3
KL 506	.562 x 1.375	1	KL 555	.825 x 2.000	2	KL 593	.625 x .812	4
KL 507	1.000 x 1.375	1	KL 556	1.000 x 1.750	2	KL 594	.750 x 1.188	4
KL 508	.500 x 1.437	1	KL 557	.562 x 1.312	2	KL 595	1.125 x 2.000	4
KL 509	.875 x 1.437	1	KL 558	.875 x 1.125	2	KL 596	.940 x 1.437	4
KL 510	.375 x 1.625	1	KL 559	.687 x 1.735	3	KL 597	.562 x 1.625	4
KL 511	.750 x 1.625	1	KL 560	.750 x 1.437	3	KL 598	.750 x .750	4
KL 512	.875 x .875	1	KL 561	.748 x 1.812	3	KL 1500	.312 x .625	3
KL 513	1.375 x .937	1	KL 562	.687 x 1.937	3	KL 1501	.812 x 1.343	4
KL 516	1.312 x 1.812	1	KL 563	.562 x 1.375	3	KL 1502	1.000 x 1.125	4
KL 517	1.250 x 2.000	1	KL 564	.805 x 2.000	3	KL 1503	.875 x 1.000	4
KL 519	.750 x 1.625	1	KL 565	.375 x 1.312	3	KL 1504	.750 x .750	4
KL 521	.812 x 1.062	1	KL 566	.750 x 3.000	3	KL 1505	1.000 x 1.000	4
KL 522	1.000 x 2.000	1	KL 567	.750 x 1.187	3	KL 1506	.750 x 1.437	4
KL 524	1.375 x 1.750	1	KL 568	.687 x .625	2	KL 1507	.687 x 2.500	5
KL 525	.625 x .750	1	KL 569	.812 x .875	2	KL 1508	1.375 x 3.375	5
KL 526	.750 x 1.125	1	KL 570	.625 x 1.999	3	KL 1509	1.250 x 1.750	5
KL 528	.687 x 1.187	1	KL 571	.500 x 1.230	3	KL 1510	1.000 x 1.250	4
KL 529	.750 x 1.500	1	KL 572	.687 x 1.375	3	KL 1511	.750 x 1.500	5
KL 530	.875 x 1.812	1	KL 573	.750 x 2.500	3	KL 1512	1.062 x 2.000	5
KL 531	.750 x 1.375	1	KL 574	.750 x 1.250	3	KL 1513	1.062 x 1.312	5
KL 532	.625 x 1.812	2	KL 575	.750 x 1.187	3	KL 1516	.500 x .500	4
KL 533	.750 x 1.750	2	KL 576	.937 x 1.125	3	KL 1517	.812 x 2.000	5
KL 538	.250 x .687	1	KL 577	.812 x 1.437	3	KL 1518	1.062 x 1.500	5
KL 539	.312 x 1.000	1	KL 578	.500 x 1.250	3	KL 1519	.750 x 1.750	5
KL 540	.228 x .700	1	KL 579	.687 x .850	3	KL 1520	.437 x 1.500	4
KL 541	1.000 x 1.062	2	KL 580	.750 x .750	3	KL 1521	1.000 x 1.250	5
KL 542	.687 x 1.375	2	KL 581	.875 x 1.000	3	KL 1522	1.093 x .750	5
KL 543	.750 x 1.750	2	KL 582	.500 x .720	3	KL 1523	.995 x 2.500	5
KL 544	.625 x 1.688	2	KL 583	.500 x .500	3	KL 1524	.687 x 1.500	5
KL 545	.437 x 1.250	2	KL 584	.625 x .875	4	KL 1525	.750 x .875	5
KL 546	1.750 x 3.625	2	KL 585	.400 x 2.000	4	KL 1526	.687 x 1.250	5
KL 547	.562 x 1.187	2	KL 586	.750 x 1.750	4	KL 1527	1.000 x 1.078	5
KL 548	.875 x 1.625	2	KL 587	1.125 x 1.062	4	KL 1528	.625 x .750	4
KL 549	.750 x 1.375	2	KL 588	1.090 x 2.000	4	KL 1529	.875 x 1.750	5
KL 550	1.000 x 1.125	2	KL 589	.625 x 1.375	4	KL 1530	1.250 x 2.500	6
KL 552	1.250 x 1.500	2	KL 590	.750 x 1.562	4	KL 1531	.625 x 1.500	5
KL 553	.475 x 1.500	2	KL 591	.687 x 1.625	4	KL 1533	.875 x 2.125	6



















































































































Panel Mold

CUSTOM PROFILE TABLE OF CONTENTS

PROFILE	SIZE	PAGE	PROFILE	SIZE	PAGE	PROFILE	SIZE	PAGE
KL 1534		.750 x 2.550 6	KL 1573		1.250 x .875 8	KL 3512		.422 x 2.000 10
KL 1535		1.062 x 1.625 6	KL 1574		1.500 x 1.437 8	KL 3513		1.000 x .750 10
KL 1536		.696 x 1.877 6	KL 1575		.687 x 1.000 8	KL 3514		1.500 x 2.000 10
KL 1537		.695 x 1.829 6	KL 1576		.437 x .875 8	KL 3515		.750 x 2.000 10
KL 1538		1.062 x 2.800 6	KL 1577		.500 x .625 8	KL 3516		1.812 x 1.625 10
KL 1540		.812 x 1.750 6	KL 1578		.500 x .625 8	KL 3517		1.687 x 1.562 10
KL 1541		.885 x 1.080 6	KL 1579		.500 x .750 8	KL 3518		.900 x 1.406 10
KL 1542		.715 x 2.267 6	KL 1580		.812 x 1.875 8	KL 3519		.750 x 1.750 10
KL 1543		.518 x .750 6	KL 1581		.500 x 1.375 8	KL 3520		1.125 x 1.062 10
KL 1544		1.000 x 1.750 6	KL 1582		1.250 x 2.312 8	KL 3521		.437 x 1.460 10
KL 1545		.812 x 1.125 6	KL 1583		1.250 x 1.094 8	KL 3522		.813 x 1.375 10
KL 1546		1.062 x 1.125 6	KL 1584		1.000 x 2.500 8	KL 3523		1.125 x 1.875 11
KL 1547		.792 x 1.778 6	KL 1585		1.000 x 5.500 8	KL 3524		.687 x .875 10
KL 1548		.312 x .750 5	KL 1586		.700 x 1.000 8	KL 3525		.750 x 2.050 11
KL 1549		.750 x 1.541 6	KL 1587		.525 x .375 8	KL 3526		1.089 x 1.000 11
KL 1550		.598 x 1.465 6	KL 1588		.350 x 1.062 8	KL 3527		.875 x 1.125 11
KL 1551		.750 x 1.668 7	KL 1589		.800 x 2.218 9	KL 3528		.812 x 2.250 11
KL 1552		1.375 x 1.625 7	KL 1590		2.250 x 2.250 9	KL 3529		.625 x 1.125 11
KL 1553		.812 x 2.625 7	KL 1591		.350 x .500 8	KL 3530		1.062 x 1.500 11
KL 1554		.875 x 2.312 7	KL 1592		.750 x 1.500 9	KL 3531		.812 x 2.375 11
KL 1555		.750 x 1.375 7	KL 1593		.749 x 1.250 8	KL 3532		.750 x 1.500 11
KL 1556		.600 x 1.375 7	KL 1594		.487 x 1.312 9	KL 3533		.500 x 1.250 11
KL 1557		1.125 x 1.125 7	KL 1595		.937 x .775 9	KL 3534		.812 x 1.000 11
KL 1558		.750 x 1.875 7	KL 1596		.600 x 2.000 9	KL 3535		1.187 x 2.000 11
KL 1559		.888 x 1.125 7	KL 1597		1.000 x 1.000 9	KL 3536		.460 x 1.750 11
KL 1560		.812 x 2.031 7	KL 1598		1.125 x 1.625 9	KL 3537		.650 x 1.625 11
KL 1561		.312 x .437 6	KL 1599		.625 x 2.500 9	KL 3538		1.000 x 1.625 11
KL 1562		.687 x 2.000 7	KL 3500		1.750 x 2.552 9	KL 3539		1.062 x 1.750 11
KL 1563		.687 x 2.000 7	KL 3501		.770 x 1.835 9	KL 3540		.812 x 2.058 11
KL 1564		1.375 x 2.250 7	KL 3502		1.687 x 2.750 9	KL 3541		.500 x .750 11
KL 1565		.750 x 1.875 7	KL 3503		1.350 x 1.730 9	KL 3542		.812 x 2.250 11
KL 1566		1.500 x 1.625 7	KL 3504		1.250 x 1.000 9	KL 3543		1.000 x 2.125 12
KL 1567		.843 x 1.843 7	KL 3505		1.406 x 1.812 10	KL 3544		.750 x 1.125 12
KL 1568		1.250 x .937 8	KL3506		1.812 x 1.375 10	KL 3545		.625 x 1.375 12
KL 1569		.750 x .875 7	KL 3507		1.375 x 1.218 10	KL 3546		.562 x .812 12
KL 1570		.750 x 1.312 8	KL3508		1.000 x 2.500 10	KL 3547		1.100 x 1.020 12
KL 1571		.720 x 1.687 8	KL 3509		.812 x 2.500 10	KL 3548		.750 x 1.125 12
KL 1572		1.100 x 1.250 8	KL 3511		.612 x .500 9	KL 3549		1.500 x 1.500 12



















































































































Panel Mold

CUSTOM PROFILE TABLE OF CONTENTS

PROFILE	SIZE	PAGE	PROFILE	SIZE	PAGE	PROFILE	SIZE	PAGE
KL 3550	 .812 x 1.437	12	KL 3588	 .562 x 1.031	14	KL 4526	 .468 x .375	16
KL 3551	 .812 x 1.125	12	KL 3589	 .812 x 1.750	14	KL 4527	 1.250 x 1.122	16
KL 3552	 .500 x .812	12	KL 3590	 .937 x 1.750	14	KL 4528	 .625 x 1.250	16
KL 3553	 1.687 x 2.875	12	KL 3591	 1.500 x 1.250	14	KL 4529	 1.250 x 1.062	16
KL 3554	 .812 x 2.220	12	KL 3592	 .770 x 1.150	14	KL 4530	 .648 x 1.684	16
KL 3555	 .340 x .750	11	KL 3593	 1.192 x 1.882	14	KL 4531	 .625 x 1.875	16
KL 3556	 1.000 x 1.750	12	KL 3594	 .625 x 1.875	14	KL 4532	 .474 x .750	16
KL 3557	 1.000 x 2.500	12	KL 3595	 1.000 x 2.420	14	KL 4533	 1.562 x 2.075	16
KL 3558	 .812 x 2.937	13	KL 3596	 1.000 x 1.187	14	KL 4534	 .875 x 1.875	16
KL 3559	 1.187 x 3.437	13	KL 3597	 .750 x 1.250	14	KL 4535	 .562 x 2.187	16
KL 3560	 1.500 x 1.125	12	KL 3598	 .562 x .750	14	KL 4536	 1.562 x 1.437	16
KL 3561	 .460 x .665	12	KL 3599	 .725 x 1.375	14	KL 4537	 .625 x 2.500	16
KL 3562	 .750 x .625	12	KL 4500	 1.750 x 1.000	15	KL 4538	 .281 x .437	15
KL 3563	 .937 x 1.937	13	KL 4501	 .516 x 1.150	14	KL 4539	 .875 x 1.000	16
KL 3564	 1.000 x 1.020	13	KL 4502	 1.250 x 1.000	15	KL 4543	 .812 x 2.375	16
KL 3565	 .812 x 2.500	13	KL 4503	 .500 x 1.250	15	KL 4544	 .594 x .655	16
KL 3566	 .812 x 1.437	13	KL 4504	 .625 x 1.125	15	KL 4545	 .750 x 1.500	16
KL 3567	 .500 x 1.000	12	KL 4505	 1.062 x 1.625	15	KL 4546	 .562 x 1.000	17
KL 3568	 .500 x .750	13	KL 4506	 1.000 x 1.750	15	KL 4547	 .750 x 1.750	17
KL 3569	 .750 x 1.375	13	KL 4507	 .875 x 1.375	15	KL 4548	 .275 x 1.375	16
KL 3570	 .687 x 1.125	13	KL 4508	 .593 x 1.125	15	KL 4549	 .625 x .750	17
KL 3571	 1.000 x 1.125	13	KL 4509	 1.000 x 3.000	15	KL 4550	 .750 x 2.500	17
KL 3572	 .750 x 2.250	13	KL 4510	 .687 x 1.125	15	KL 4551	 1.375 x .750	17
KL 3573	 .835 x 1.375	13	KL 4511	 .423 x 1.089	15	KL 4552	 1.062 x 1.750	17
KL 3574	 .562 x .843	13	KL 4512	 .500 x .682	14	KL 4553	 1.062 x 2.562	17
KL 3575	 .562 x .718	13	KL 4513	 .844 x 1.514	15	KL 4554	 .437 x .750	17
KL 3576	 .600 x 1.161	13	KL 4514	 .625 x 1.875	15	KL 4555	 .594 x 1.500	17
KL 3577	 .750 x 2.000	13	KL 4515	 .468 x .937	15	KL 4556	 1.125 x 1.875	17
KL 3578	 1.000 x 2.375	13	KL 4516	 .455 x 3.188	15	KL 4557	 .582 x 1.063	17
KL 3579	 .875 x 1.828	13	KL 4517	 1.031 x 1.250	15	KL 4558	 .625 x 1.375	17
KL 3580	 .696 x 2.000	14	KL 4518	 1.875 x 1.500	15	KL 4559	 .458 x 1.375	17
KL 3581	 .645 x 1.812	14	KL 4519	 .750 x 1.500	15	KL 4560	 1.000 x 2.000	17
KL 3582	 .750 x .750	13	KL 4520	 .750 x 1.750	15	KL 4561	 .812 x 2.312	17
KL 3583	 .812 x 1.960	14	KL 4521	 .750 x 1.125	16	KL 4562	 .750 x 1.468	17
KL 3584	 .750 x 1.250	14	KL 4522	 .750 x 1.000	16	KL 4563	 .600 x .875	17
KL 3585	 .598 x 1.990	13	KL 4523	 .750 x 1.000	16	KL 4564	 .625 x 2.000	17
KL 3586	 .812 x 3.187	14	KL 4524	 .875 x 1.500	16	KL 4565	 .750 x .750	17
KL 3587	 .900 x 2.187	14	KL 4525	 .687 x 1.125	16	KL 4567	 .750 x 1.125	17



















































































































Panel Mold

CUSTOM PROFILE TABLE OF CONTENTS

PROFILE	SIZE	PAGE	PROFILE	SIZE	PAGE	PROFILE	SIZE	PAGE
KL 4572	 1.125 x 1.062	17	KL 5512	 1.125 x 1.063	19	KL 5550	 .687 x 1.562	21
KL 4573	 1.500 x 1.625	18	KL 5513	 1.374 x 5.375	19	KL 5551	 1.250 x .750	21
KL 4576	 1.000 x .875	18	KL 5514	 1.406 x 3.312	20	KL 5552	 1.687 x 1.125	22
KL 4577	 .687 x 1.750	18	KL 5515	 1.500 x 3.500	20	KL 5553	 .812 x 1.375	21
KL 4578	 .998 x .937	18	KL 5516	 .812 x 1.375	19	KL 5554	 .625 x 2.000	22
KL 4579	 .749 x 1.500	18	KL 5517	 .437 x .812	18	KL 5555	 .687 x 1.500	22
KL 4580	 .750 x 1.312	18	KL 5518	 .812 x 2.000	20	KL 5556	 .750 x 2.750	22
KL 4581	 .875 x 1.875	18	KL 5519	 1.000 x 1.625	20	KL 5557	 .375 x .750	21
KL 4582	 .406 x .375	17	KL 5520	 1.000 x 1.625	20	KL 5558	 .750 x 2.250	22
KL 4583	 1.250 x .750	18	KL 5521	 .613 x .925	19	KL 5559	 .625 x 1.187	21
KL 4584	 .812 x 1.812	18	KL 5522	 .538 x .811	19	KL 5560	 .250 x .350	20
KL 4585	 .875 x 1.500	18	KL 5523	 .875 x 1.250	20	KL 5561	 .500 x 1.250	22
KL 4586	 .250 x .717	17	KL 5524	 .812 x 1.937	20	KL 5562	 .812 x 3.000	22
KL 4587	 .468 x .700	18	KL 5525	 1.625 x 2.000	20	KL 5563	 .875 x 2.000	22
KL 4588	 .650 x .625	18	KL 5526	 .844 x 3.937	20	KL 5564	 .750 x 1.750	22
KL 4589	 .750 x 2.750	18	KL 5527	 .750 x 1.000	20	KL 5565	 .750 x 1.437	22
KL 4590	 1.000 x 1.937	18	KL 5528	 .750 x 1.343	20	KL 5566	 1.500 x 1.750	22
KL 4591	 .625 x 1.625	18	KL 5529	 .375 x 1.000	20	KL 5567	 .437 x .562	22
KL 4592	 .812 x 1.875	18	KL 5530	 .625 x 1.250	20	KL 5568	 .375 x 1.000	22
KL 4593	 .312 x 1.000	18	KL 5531	 1.000 x 4.500	21	KL 5569	 .500 x .750	22
KL 4594	 .875 x 1.812	18	KL 5532	 .750 x 1.000	20	KL 5570	 .750 x 1.000	22
KL 4595	 .375 x 1.000	18	KL 5533	 .750 x .750	20	KL 5571	 1.187 x .875	22
KL 4596	 .750 x 1.750	18	KL 5534	 .750 x 1.500	20	KL 5572	 .687 x .937	22
KL 4597	 .343 x .468	18	KL 5535	 .812 x 2.375	21	KL 5573	 .937 x 1.500	22
KL 4598	 .812 x 1.500	19	KL 5536	 .625 x .875	20	KL 5574	 .625 x .875	22
KL 4599	 .812 x 2.000	19	KL 5537	 1.125 x 1.250	21	KL 5575	 .750 x 1.125	22
KL 5500	 .785 x 1.780	19	KL 5538	 .750 x .875	21	KL 5576	 .375 x .875	22
KL 5501	 .687 x 1.812	19	KL 5539	 1.000 x 1.437	21	KL 5577	 1.250 x 1.625	23
KL 5502	 1.062 x .875	19	KL 5540	 1.062 x 1.500	21	KL 5578	 .467 x .902	22
KL 5503	 1.250 x 1.000	19	KL 5541	 .687 x 2.739	21	KL 5579	 .562 x 1.000	23
KL 5504	 .812 x 2.250	19	KL 5542	 .562 x .687	20	KL 5580	 .375 x .437	22
KL 5505	 .625 x .438	18	KL 5543	 .750 x 1.750	21	KL 5581	 .750 x 2.437	23
KL 5506	 .538 x .370	18	KL 5544	 .687 x 1.812	21	KL 5582	 .750 x 1.250	23
KL 5507	 .625 x 1.500	19	KL 5545	 .375 x .875	21	KL 5583	 1.015 x 2.500	23
KL 5508	 1.000 x 1.250	19	KL 5546	 .750 x 1.500	21	KL 5584	 1.500 x 1.500	23
KL 5509	 1.375 x 1.250	19	KL 5547	 .562 x 1.125	21	KL 5585	 .750 x 1.750	23
KL 5510	 .750 x 1.906	19	KL 5548	 1.000 x .878	21	KL 5586	 1.125 x 1.875	23
KL 5511	 .596 x 2.650	19	KL 5549	 1.000 x 2.875	21	KL 5587	 .500 x .875	23



















































































































Panel Mold

CUSTOM PROFILE TABLE OF CONTENTS

PROFILE	SIZE	PAGE	PROFILE	SIZE	PAGE	PROFILE	SIZE	PAGE
KL 5588	 .250 x .750	22	KL 6532	 1.953 x 1.500	25	KL 6572	 1.062 x .625	27
KL 5589	 .750 x 1.500	23	KL 6533	 1.187 x 2.750	25	KL 6573	 .562 x .750	26
KL 5590	 .442 x 1.250	23	KL 6534	 .312 x .875	24	KL 6576	 1.062 x 1.375	27
KL 5592	 .500 x 2.000	23	KL 6535	 1.375 x 1.937	25	KL 6577	 .875 x 1.250	27
KL 5593	 .687 x .750	23	KL 6536	 1.250 x 1.375	25	KL 6578	 .687 x 1.625	27
KL 5594	 .750 x 1.250	23	KL 6537	 .625 x 1.687	25	KL 6579	 1.062 x 2.312	27
KL 5595	 1.250 x 2.000	23	KL 6538	 .500 x .875	25	KL 6580	 .687 x 1.250	27
KL 5596	 .687 x 1.125	23	KL 6539	 1.875 x 2.812	25	KL 6581	 1.437 x 1.750	27
KL 5598	 .688 x 1.437	23	KL 6540	 .750 x 2.062	25	KL 6582	 1.500 x 1.937	27
KL 5599	 .462 x 1.000	23	KL 6541	 .850 x 2.062	26	KL 6584	 .875 x 1.500	27
KL 6501	 1.000 x 3.632	24	KL 6542	 .750 x .937	25	KL 6585	 .625 x .950	27
KL 6502	 .375 x 1.000	23	KL 6543	 1.000 x .750	26	KL 6586	 .750 x 1.000	27
KL 6503	 .750 x 2.250	24	KL 6544	 .375 x 1.000	25	KL 6587	 .625 x .875	27
KL 6504	 .750 x 1.500	24	KL 6545	 .437 x 1.000	25	KL 6588	 .225 x .730	26
KL 6505	 .875 x 1.125	24	KL 6546	 .937 x 2.125	26	KL 6589	 .625 x 1.625	27
KL 6506	 1.312 x 1.875	24	KL 6547	 1.062 x 2.875	26	KL 6590	 1.126 x 1.312	27
KL 6507	 1.500 x 1.625	24	KL 6548	 .500 x .730	25	KL 6591	 1.000 x 1.404	27
KL 6508	 1.582 x 1.500	24	KL 6549	 .514 x 1.476	26	KL 6592	 .650 x 1.250	27
KL 6510	 1.125 x 1.750	24	KL 6550	 .540 x 1.574	26	KL 6593	 .750 x .750	27
KL 6511	 .250 x .750	23	KL 6552	 1.000 x 1.000	26	KL 6594	 1.375 x 2.500	28
KL 6512	 .750 x 1.562	24	KL 6553	 1.000 x 2.000	26	KL 6595	 .687 x 1.312	28
KL 6513	 .930 x 1.045	24	KL 6554	 .625 x 1.812	26	KL 6597	 .750 x 3.625	28
KL 6514	 .812 x 1.500	24	KL 6555	 .500 x .625	25	KL 6599	 .500 x .875	27
KL 6515	 .500 x .750	24	KL 6556	 .687 x 2.031	26	KL 7500	 .410 x 1.500	28
KL 6517	 .462 x 2.687	24	KL 6557	 .687 x 1.875	26	KL 7501	 1.312 x 1.250	28
KL 6518	 1.125 x 1.125	24	KL 6558	 .500 x 1.500	26	KL 7502	 .750 x .812	28
KL 6520	 .750 x 1.375	24	KL 6559	 .750 x 1.750	26	KL 7503	 .812 x .750	28
KL 6521	 .486 x .750	24	KL 6560	 .875 x 1.500	26	KL 7504	 .812 x 1.500	28
KL 6522	 1.000 x 2.000	24	KL 6561	 .495 x .587	26	KL 7506	 .375 x .580	28
KL 6523	 .440 x 3.000	25	KL 6562	 .625 x 1.687	26	KL 7507	 .437 x .700	28
KL 6524	 .812 x 1.750	25	KL 6563	 .812 x 1.625	26	KL 7508	 .320 x .615	28
KL 6525	 .250 x .500	23	KL 6564	 .749 x .812	26	KL 7509	 .750 x 1.687	28
KL 6526	 .750 x 2.437	25	KL 6565	 .430 x 1.088	26	KL 7510	 .750 x 1.684	28
KL 6527	 .687 x .812	25	KL 6566	 .687 x 1.000	26	KL 7511	 .750 x 1.500	28
KL 6528	 .750 x 1.375	25	KL 6567	 .500 x .750	26	KL 7512	 .563 x 1.500	28
KL 6529	 .750 x 1.000	25	KL 6568	 1.250 x 2.562	27	KL 7513	 .563 x .750	28
KL 6530	 .375 x .750	24	KL 6570	 .812 x 2.437	27	KL 7514	 .750 x 2.000	28
KL 6531	 .840 x 1.250	25	KL 6571	 .750 x 1.625	26	KL 7515	 .500 x 1.250	28

Panel Mold

CUSTOM PROFILE TABLE OF CONTENTS

PROFILE	SIZE	PAGE	PROFILE	SIZE	PAGE	PROFILE	SIZE	PAGE			
KL 7516		1.168 x 2.515	28	KL 7556		.625 x 1.500	30	KL 9500		.750 x 1.312	32
KL 7517		.750 x 2.186	28	KL 7557		.750 x 1.000	30	KL 9501		1.216 x 1.446	32
KL 7518		.687 x 1.812	29	KL 7558		.250 x .500	29	KL 9502		.562 x 2.250	32
KL 7519		.900 x 3.000	29	KL 7560		.500 x 2.250	30	KL 9503		1.312 x 1.000	32
KL 7520		.625 x .750	28	KL 7561		.812 x 2.250	30	KL 9504		.687 x 1.062	32
KL 7521		.750 x 1.437	29	KL 7562		.750 x .750	30	KL 9505		.235 x .375	31
KL 7522		.437 x .687	28	KL 7563		.600 x .850	30	KL 9506		1.250 x 2.500	32
KL 7523		.563 x .875	29	KL 7564		.562 x 1.250	30	KL 9507		.774 x 1.199	32
KL 7524		.750 x 1.375	29	KL 7568		.250 x .500	29	KL 9508		.750 x 1.625	32
KL 7525		.625 x .687	29	KL 7569		.625 x 1.750	31	KL 9509		1.625 x 1.062	32
KL 7526		.687 x 1.750	29	KL 7571		.750 x .750	31	KL 9510		.812 x 2.000	32
KL 7527		.875 x 1.625	29	KL 7572		1.937 x 1.500	31	KL 9511		.950 x 1.500	32
KL 7528		1.563 x 1.298	29	KL 7574		1.312 x 1.937	31	KL 9512		.625 x .700	32
KL 7529		.750 x .750	29	KL 7575		.563 x 1.000	31	KL 9513		.875 x 1.875	33
KL 7530		.937 x 1.875	29	KL 7576		.563 x .500	31	KL 9515		1.062 x 2.221	33
KL 7531		.500 x .750	29	KL 7577		.938 x 1.000	31	KL 9516		.291 x .505	32
KL 7532		.812 x 2.000	29	KL 7578		.687 x 1.937	31	KL 9518		.235 x .545	32
KL 7533		.750 x 1.375	29	KL 7579		1.250 x 1.250	31	KL 9519		.812 x 1.687	33
KL 7534		.750 x 1.250	29	KL 7580		.250 x .500	31	KL 9520		.670 x 1.277	33
KL 7536		1.750 x 1.750	29	KL 7581		1.000 x 1.312	31	KL 9522		1.250 x 1.937	33
KL 7537		.687 x 1.250	29	KL 7582		1.375 x .750	31	KL 9523		.687 x 2.187	33
KL 7538		.437 x 1.437	29	KL 7583		1.250 x .750	31	KL 9524		1.250 x .750	33
KL 7539		.805 x 2.937	29	KL 7584		1.375 x 2.000	31	KL 9525		.812 x 1.625	33
KL 7540		.875 x 2.000	30	KL 7585		.750 x 2.000	31	KL 9526		1.125 x 2.250	33
KL 7541		.625 x 1.500	30	KL 7586		.420 x 1.125	31	KL 9527		1.000 x 1.500	33
KL 7542		.875 x 1.500	30	KL 7587		.562 x 1.125	31	KL 9529		1.125 x .750	33
KL 7543		.470 x 2.500	30	KL 7588		.575 x 1.125	31	KL 9530		.750 x 1.687	33
KL 7544		.375 x 1.375	30	KL 7589		.200 x .625	31	KL 9531		1.250 x 1.250	33
KL 7545		.750 x 1.750	30	KL 7590		.500 x .625	31	KL 9532		.972 x 1.541	33
KL 7546		.750 x 2.000	30	KL 7591		.563 x 1.250	31	KL 9533		.500 x 1.312	33
KL 7547		1.062 x 1.375	30	KL 7592		1.375 x 1.562	31	KL 9534		.750 x 1.678	33
KL 7548		.562 x 2.125	30	KL 7593		1.000 x 1.625	31	KL 9535		1.250 x 1.187	33
KL 7550		.812 x 2.875	30	KL 7594		1.187 x 2.875	32	KL 9536		1.250 x 1.250	33
KL 7551		.625 x 2.000	30	KL 7595		.750 x 1.750	32	KL 9537		.687 x 1.125	33
KL 7552		1.000 x 1.500	30	KL 7596		.812 x .812	31	KL 9538		1.062 x 1.500	34
KL 7553		.937 x 1.562	30	KL 7597		.875 x 3.000	32	KL 9539		.687 x .812	34
KL 7554		1.062 x .937	30	KL 7598		.470 x .888	32	KL 9540		1.375 x 1.750	34
KL 7555		.425 x .750	29	KL 7599		.875 x 2.250	32	KL 9541		.972 x .719	34



















































































































Panel Mold

CUSTOM PROFILE TABLE OF CONTENTS

PROFILE	SIZE	PAGE	PROFILE	SIZE	PAGE	PROFILE	SIZE	PAGE
KL 9542	.795 x .822	34	KL 9582	.517 x 1.250	35	KL 11526	.937 x 1.062	37
KL 9543	.625 x 1.250	34	KL 9583	.500 x .812	35	KL 11527	.625 x .750	37
KL 9545	.500 x .750	34	KL 9584	1.375 x 1.062	35	KL 11528	.531 x 1.000	37
KL 9546	1.562 x 1.000	34	KL 9585	.312 x .750	35	KL 11529	1.500 x 1.483	37
KL 9547	.500 x .875	34	KL 9586	.625 x 1.000	35	KL 11530	.875 x 1.500	37
KL 9548	.437 x .750	34	KL 9587	1.375 x 1.000	36	KL 11531	.562 x 1.500	37
KL 9549	.437 x .500	33	KL 9588	.500 x 1.000	35	KL 11532	.750 x 1.500	37
KL 9550	1.125 x 1.750	34	KL 9589	1.250 x .750	36	KL 11533	.812 x 2.750	37
KL 9551	.500 x .562	34	KL 9590	.687 x 1.312	36	KL 11534	1.350 x 1.812	37
KL 9552	.625 x 1.000	34	KL 9591	.500 x 1.500	36	KL 11535	.500 x .875	37
KL 9553	.437 x .687	34	KL 9592	.875 x .937	36	KL 11537	.245 x .538	37
KL 9554	1.500 x 2.000	34	KL 9593	.812 x 2.625	36	KL 11538	.812 x 1.750	37
KL 9555	.562 x 1.187	34	KL 9596	.625 x .875	36	KL 11539	1.125 x .750	38
KL 9556	.183 x .282	34	KL 9597	.687 x 1.093	36	KL 11540	.500 x .714	37
KL 9557	1.187 x .812	34	KL 9598	.625 x .750	36	KL 11541	.656 x .625	37
KL 9558	.625 x .939	34	KL 9599	.812 x 1.687	36	KL 11542	2.000 x 1.625	38
KL 9559	1.000 x 1.125	34	KL 11500	1.062 x 1.125	36	KL 11543	1.000 x 2.687	38
KL 9560	1.250 x 1.250	34	KL 11501	.750 x 1.250	36	KL 11544	.625 x .937	38
KL 9561	.500 x .812	34	KL 11502	.750 x 2.000	36	KL 11545	.875 x 2.500	38
KL 9562	.937 x 2.062	34	KL 11503	1.469 x 1.000	36	KL 11546	.437 x 1.000	38
KL 9563	.812 x 1.562	34	KL 11504	1.000 x 2.125	36	KL 11547	.551 x .500	37
KL 9564	.437 x .750	34	KL 11505	.812 x 1.187	36	KL 11548	1.062 x 1.750	38
KL 9565	.375 x 1.000	34	KL 11506	.687 x 1.250	36	KL 11549	.500 x 1.250	38
KL 9567	.437 x 1.875	35	KL 11507	.625 x .750	36	KL 11550	.750 x 1.972	38
KL 9568	.500 x 1.062	35	KL 11508	1.500 x 1.250	36	KL 11551	.750 x 1.750	38
KL 9569	.937 x 1.000	35	KL 11509	.750 x 1.750	36	KL 11552	.750 x 1.000	38
KL 9570	.750 x 1.875	35	KL 11510	.812 x 1.829	36	KL 11553	1.000 x 1.937	38
KL 9571	1.000 x 1.250	35	KL 11511	1.250 x 1.187	37	KL 11554	.950 x 1.125	38
KL 9572	.500 x .750	35	KL 11512	.625 x .750	36	KL 11555	.625 x 1.062	38
KL 9573	.687 x 1.687	35	KL 11513	1.000 x 1.500	37	KL 11556	1.063 x 1.500	38
KL 9574	1.031 x 1.312	35	KL 11516	.312 x .750	36	KL 11557	.621 x 1.596	38
KL 9575	.593 x 2.188	35	KL 11517	.234 x .937	37	KL 11558	1.437 x 1.031	38
KL 9576	1.062 x 2.000	35	KL 11519	.625 x 1.156	37	KL 11559	.534 x .750	38
KL 9577	.750 x 1.125	35	KL 11521	.750 x 2.250	37	KL 11560	1.528 x 2.227	39
KL 9578	1.000 x 1.500	35	KL 11522	1.250 x 1.437	37	KL 11561	.746 x 1.336	38
KL 9579	1.000 x 2.750	35	KL 11523	.562 x 1.000	37	KL 11562	1.000 x 1.250	39
KL 9580	1.687 x 2.000	35	KL 11524	.531 x 1.250	37	KL 11563	.812 x 2.000	39
KL 9581	.625 x .937	35	KL 11525	1.125 x 1.062	37	KL 11564	.778 x 1.687	39



















































































































Panel Mold

CUSTOM PROFILE TABLE OF CONTENTS

PROFILE	SIZE	PAGE	PROFILE	SIZE	PAGE	PROFILE	SIZE	PAGE
KL 11565 	.656 x .875	39	KL 13505 	1.125 x 2.500	40	KL 13547 	.750 x 1.687	42
KL 11566 	1.281 x .875	39	KL 13506 	1.250 x 1.500	40	KL 13548 	.750 x 1.125	42
KL 11567 	.625 x .812	39	KL 13507 	.687 x 1.125	40	KL 13549 	1.062 x 1.750	42
KL 11568 	.625 x .875	39	KL 13508 	1.125 x 1.625	41	KL 13550 	1.000 x 1.531	42
KL 11569 	.625 x 1.750	39	KL 13509 	1.187 x 1.875	41	KL 13551 	1.187 x .749	42
KL 11570 	1.082 x 1.959	39	KL 13510 	1.187 x 1.687	41	KL 13552 	.385 x .750	42
KL 11571 	.562 x 1.062	39	KL 13511 	1.125 x 1.812	41	KL 13553 	.812 x 1.500	42
KL 11572 	.750 x 1.147	39	KL 13512 	.281 x .875	40	KL 13554 	.625 x 1.500	42
KL 11573 	.923 x 1.256	39	KL 13513 	.437 x .750	40	KL 13555 	.437 x .750	42
KL 11574 	.750 x .812	39	KL 13516 	1.123 x .750	41	KL 13556 	1.250 x 1.375	43
KL 11575 	.812 x 1.062	39	KL 13518 	.625 x .625	40	KL 13557 	.625 x 1.000	43
KL 11576 	.562 x 1.250	39	KL 13519 	.406 x .750	41	KL 13558 	1.562 x 1.437	43
KL 11577 	.687 x 1.000	39	KL 13520 	.812 x 1.250	41	KL 13559 	.750 x .750	43
KL 11578 	.625 x 1.375	39	KL 13521 	.500 x 1.000	41	KL 13560 	1.687 x 1.390	43
KL 11579 	1.125 x 1.125	39	KL 13522 	.750 x .750	41	KL 13561 	.750 x 1.250	43
KL 11580 	.889 x 2.029	39	KL 13523 	1.250 x 1.000	41	KL 13562 	1.250 x 1.250	43
KL 11581 	.687 x 1.562	39	KL 13524 	.500 x .939	41	KL 13563 	.500 x 1.250	43
KL 11582 	.598 x .730	39	KL 13525 	.813 x 1.875	41	KL 13564 	1.000 x 1.625	43
KL 11583 	1.062 x 1.187	40	KL 13527 	1.250 x 1.500	41	KL 13565 	.750 x .562	43
KL 11584 	.510 x 1.090	40	KL 13528 	1.125 x 2.125	41	KL 13566 	.500 x .750	42
KL 11585 	.723 x .975	40	KL 13529 	1.500 x 2.250	41	KL 13567 	.750 x 2.250	43
KL 11586 	.750 x 2.562	40	KL 13530 	.812 x 1.375	41	KL 13568 	1.625 x 2.375	43
KL 11587 	.250 x .500	39	KL 13531 	1.500 x 2.000	41	KL 13569 	1.375 x 2.000	43
KL 11588 	.188 x .840	39	KL 13532 	1.250 x 1.000	41	KL 13571 	.875 x 1.062	43
KL 11589 	2.031 x 2.000	40	KL 13533 	.562 x .875	41	KL 13572 	1.250 x .781	43
KL 11590 	.687 x .812	40	KL 13534 	1.000 x 2.375	42	KL 13573 	.468 x 1.125	43
KL 11591 	.625 x 1.000	40	KL 13535 	.750 x 1.687	42	KL 13574 	1.250 x 1.375	43
KL 11592 	.625 x .625	40	KL 13536 	.219 x .250	39	KL 13575 	1.125 x 3.000	44
KL 11594 	.718 x 1.062	40	KL 13537 	.813 x 1.000	42	KL 13576 	.625 x .750	43
KL 11596 	.750 x 1.750	40	KL 13538 	1.500 x 1.438	42	KL 13577 	.625 x 1.375	43
KL 11597 	.750 x 1.156	40	KL 13539 	1.500 x 1.000	42	KL 13580 	.625 x 1.250	44
KL 11598 	.812 x 1.562	40	KL 13540 	.625 x 1.500	42	KL 13581 	.625 x 1.250	44
KL 11599 	.750 x 1.375	40	KL 13541 	.812 x 1.500	42	KL 13582 	.781 x 2.062	44
KL 13500 	.625 x 1.000	40	KL 13542 	.625 x 1.625	42	KL 13583 	.625 x 1.250	44
KL 13501 	.625 x 1.187	40	KL 13543 	.608 x 1.187	42	KL 13584 	.813 x 2.750	44
KL 13502 	1.187 x 1.375	40	KL 13544 	.625 x 1.250	42	KL 13585 	.750 x 1.500	44
KL 13503 	.750 x .750	40	KL 13545 	.750 x 1.125	42	KL 13586 	.625 x 1.437	44
KL 13504 	.312 x .500	40	KL 13546 	.625 x 2.125	42	KL 13587 	.750 x 1.812	44



















































































































Panel Mold

CUSTOM PROFILE TABLE OF CONTENTS

PROFILE	SIZE	PAGE	PROFILE	SIZE	PAGE	PROFILE	SIZE	PAGE
KL 13588 	.750 x 1.125	44	KL 14528 	1.125 x 4.000	46	KL 14569 	.562 x 1.156	48
KL 13589 	.625 x .875	44	KL 14529 	.437 x .750	46	KL 14570 	.437 x .843	48
KL 13590 	.500 x .562	43	KL 14530 	.781 x 2.000	46	KL 14571 	.375 x 1.531	48
KL 13591 	1.281 x 1.968	44	KL 14531 	.812 x 1.312	46	KL 14572 	1.000 x 1.000	48
KL 13592 	.562 x .750	44	KL 14532 	1.375 x 1.750	46	KL 14573 	.750 x 1.000	48
KL 13593 	.812 x 2.062	44	KL 14533 	.656 x 1.000	46	KL 14574 	1.375 x 1.375	48
KL 13594 	.843 x 2.625	44	KL 14534 	.437 x .656	46	KL 14575 	.750 x 1.125	48
KL 13595 	.625 x 1.125	44	KL 14535 	.562 x .750	46	KL 14576 	.156 x .500	46
KL 13596 	.812 x 2.375	44	KL 14536 	.750 x .750	46	KL 14577 	.750 x 1.250	48
KL 13597 	.472 x 1.265	44	KL 14538 	.500 x .937	46	KL 14578 	1.250 x 1.312	48
KL 13598 	1.125 x 1.250	44	KL 14539 	.562 x 1.000	46	KL 14580 	.625 x .750	48
KL 13599 	1.750 x 3.500	45	KL 14540 	1.125 x 1.000	46	KL 14581 	.562 x .875	48
KL 14500 	.750 x 1.000	44	KL 14541 	.625 x 1.000	46	KL 14582 	.500 x 1.000	48
KL 14501 	1.250 x .750	45	KL 14542 	1.625 x 2.000	46	KL 14583 	.375 x .750	48
KL 14502 	.750 x .750	45	KL 14543 	.437 x 1.125	46	KL 14584 	1.750 x 1.875	48
KL 14503 	.687 x 1.000	45	KL 14544 	1.062 x .625	47	KL 14585 	.500 x .625	48
KL 14504 	1.687 x 1.500	45	KL 14545 	.812 x 1.750	47	KL 14586 	1.140 x 2.468	48
KL 14505 	.750 x 1.750	45	KL 14546 	.812 x .937	47	KL 14587 	.500 x .750	48
KL 14506 	.750 x 2.250	45	KL 14547 	.625 x .765	47	KL 14588 	2.000 x 2.000	48
KL 14507 	.812 x 1.750	45	KL 14548 	.640 x 1.375	47	KL 14589 	1.125 x 1.375	48
KL 14509 	1.343 x 1.125	45	KL 14549 	1.000 x 1.750	47	KL 14590 	.656 x 1.125	48
KL 14510 	.750 x 1.750	45	KL 14550 	.500 x 3.500	47	KL 14592 	.750 x 1.250	48
KL 14511 	1.250 x .625	45	KL 14551 	.500 x .875	47	KL 14595 	.812 x 1.250	49
KL 14512 	.812 x 1.875	45	KL 14552 	1.000 x 1.125	47	KL 14596 	.500 x 1.000	48
KL 14513 	.328 x .468	45	KL 14553 	.687 x 3.250	47	KL 14597 	1.000 x 2.000	49
KL 14514 	.625 x 1.125	45	KL 14554 	.625 x 1.250	47	KL 14598 	.812 x 1.625	49
KL 14515 	1.125 x 1.250	45	KL 14555 	1.093 x 1.750	47	KL 14599 	.875 x 1.437	49
KL 14517 	1.000 x 1.875	45	KL 14558 	1.062 x 1.750	47	KL 15501 	1.000 x 1.125	49
KL 14518 	1.093 x 1.750	45	KL 14559 	.625 x 1.375	47	KL 15502 	.813 x 2.187	49
KL 14519 	1.125 x 1.031	45	KL 14560 	.668 x 1.270	47	KL 15503 	.500 x 2.000	49
KL 14520 	.437 x .812	45	KL 14561 	.750 x 1.750	47	KL 15504 	.750 x 1.125	49
KL 14521 	.406 x 1.000	45	KL 14562 	1.187 x 1.250	47	KL 15505 	1.688 x 1.000	49
KL 14522 	.750 x 2.125	46	KL 14563 	.750 x 1.500	47	KL 15506 	.375 x .875	48
KL 14523 	.875 x 1.300	46	KL 14564 	1.500 x 1.187	47	KL 15507 	.750 x 1.750	49
KL 14524 	.750 x 1.250	46	KL 14565 	.390 x .875	47	KL 15508 	.750 x 1.937	49
KL 14525 	.375 x 1.062	46	KL 14566 	1.031 x 1.343	47	KL 15509 	1.500 x 1.062	49
KL 14526 	.875 x 1.125	46	KL 14567 	.625 x .812	47	KL 15510 	.562 x .625	49
KL 14527 	.750 x 2.250	46	KL 14568 	.703 x .812	48	KL 15511 	.625 x .781	49



















































































































Panel Mold

CUSTOM PROFILE TABLE OF CONTENTS

PROFILE	SIZE	PAGE	PROFILE	SIZE	PAGE	PROFILE	SIZE	PAGE
KL 15512 	.718 x 1.000	49	KL 15552 	1.750 x 1.375	51	KL 16500 	.750 x 1.500	53
KL 15513 	.625 x 1.500	49	KL 15553 	.500 x 1.250	50	KL 16501 	.438 x .500	52
KL 15514 	.625 x 1.875	49	KL 15555 	.718 x 1.062	51	KL 16502 	.859 x 1.375	53
KL 15515 	1.187 x 1.250	49	KL 15557 	.625 x 1.062	51	KL 16504 	1.125 x 2.125	53
KL 15516 	1.000 x 1.687	49	KL 15558 	.296 x .546	50	KL 16505 	.510 x .935	53
KL 15517 	.625 x 2.000	49	KL 15559 	.750 x 1.500	51	KL 16506 	1.625 x 1.625	53
KL 15518 	.750 x .750	49	KL 15562 	1.000 x 2.000	51	KL 16507 	2.500 x 1.625	53
KL 15519 	.812 x 1.500	50	KL 15564 	.434 x .750	51	KL 16508 	.219 x .531	51
KL 15520 	.312 x .875	49	KL 15565 	.312 x .500	49	KL 16509 	.520 x .740	53
KL 15521 	1.625 x 1.750	50	KL 15566 	1.312 x 1.687	51	KL 16510 	1.750 x 1.250	53
KL 15522 	1.094 x 1.750	50	KL 15567 	.750 x 1.250	51	KL 16511 	1.062 x 2.187	54
KL 15523 	.406 x .812	50	KL 15568 	1.375 x 1.375	52	KL 16512 	.734 x 1.750	53
KL 15524 	1.125 x 1.844	50	KL 15569 	.500 x .500	51	KL 16513 	.625 x 1.343	53
KL 15525 	1.000 x 1.500	50	KL 15570 	1.185 x .750	52	KL 16514 	1.437 x 2.312	54
KL 15526 	.563 x .843	50	KL 15571 	1.125 x 2.438	52	KL 16515 	1.437 x 2.312	54
KL 15527 	.343 x .421	48	KL 15572 	.812 x 1.437	52	KL 16516 	.641 x .750	53
KL 15528 	.380 x 2.625	50	KL 15573 	1.312 x .750	52	KL 16517 	.438 x .562	53
KL 15530 	.687 x 1.250	50	KL 15574 	1.250 x 1.625	52	KL 16518 	1.063 x 1.063	54
KL 15531 	.625 x 1.125	50	KL 15575 	.812 x 1.500	52	KL 16519 	.687 x 1.375	54
KL 15532 	.407 x .750	50	KL 15576 	.484 x 1.562	52	KL 16520 	.835 x 1.562	54
KL 15533 	2.312 x 1.937	50	KL 15577 	.812 x 1.375	52	KL 16521 	.500 x 1.125	54
KL 15534 	1.125 x 2.125	50	KL 15578 	.718 x 1.375	52	KL 16523 	.500 x .938	54
KL 15535 	1.125 x 1.125	50	KL 15579 	1.437 x 1.375	52	KL 16524 	1.125 x 1.875	54
KL 15536 	.531 x 1.156	50	KL 15581 	.312 x .968	50	KL 16525 	.250 x .625	54
KL 15537 	.250 x .750	48	KL 15583 	.656 x 1.250	52	KL 16527 	.656 x .875	54
KL 15538 	.625 x 1.250	50	KL 15584 	1.250 x 2.500	52	KL 16528 	.375 x 1.500	54
KL 15540 	.391 x .687	50	KL 15585 	.750 x 1.250	52	KL 16529 	.406 x .875	54
KL 15541 	1.750 x 2.125	51	KL 15586 	.750 x 1.687	52	KL 16530 	.563 x .937	54
KL 15542 	.781 x 1.312	50	KL 15587 	.500 x 1.375	52	KL 16531 	.500 x .687	54
KL 15543 	1.000 x 1.750	51	KL 15589 	.812 x 1.375	52	KL 16532 	.875 x 2.875	54
KL 15544 	.406 x .843	50	KL 15590 	.750 x .750	51	KL 16533 	1.250 x 2.062	54
KL 15545 	.875 x 3.062	51	KL 15592 	2.000 x 1.625	53	KL 16534 	1.125 x 1.625	54
KL 15546 	1.500 x 1.250	51	KL 15593 	2.125 x 1.062	53	KL 16535 	1.875 x 1.812	55
KL 15547 	1.125 x 2.437	51	KL 15594 	1.000 x 2.625	52	KL 16536 	.875 x 1.125	54
KL 15548 	1.000 x 1.656	51	KL 15595 	.921 x 2.562	53	KL 16537 	1.375 x 3.250	55
KL 15549 	.250 x .781	50	KL 15597 	.750 x 1.375	52	KL 16538 	.625 x .875	54
KL 15550 	.625 x .937	51	KL 15598 	.750 x 1.750	53	KL 16539 	1.500 x 1.625	55
KL 15551 	1.358 x 1.875	51	KL 15599 	1.250 x .812	53	KL 16540 	1.750 x 2.000	55



















































































































Panel Mold

CUSTOM PROFILE TABLE OF CONTENTS

PROFILE	SIZE	PAGE	PROFILE	SIZE	PAGE	PROFILE	SIZE	PAGE
KL 16542 	.750 x 1.187	55	KL 16588 	.625 x 1.562	57	KL 17529 	.500 x 1.250	58
KL 16544 	1.000 x .937	55	KL 16589 	.750 x 2.500	57	KL 17530 	1.750 x 1.062	59
KL 16545 	.312 x .812	55	KL 16590 	.625 x 1.375	57	KL 17531 	.812 x 2.750	58
KL 16546 	.937 x 1.750	55	KL 16592 	.500 x 1.000	56	KL 17532 	.781 x .906	59
KL 16549 	.937 x 4.375	55	KL 16593 	1.625 x .750	57	KL 17533 	.812 x 2.250	59
KL 16550 	1.000 x 2.000	55	KL 16594 	.625 x 1.500	57	KL 17535 	1.437 x 2.375	59
KL 16551 	1.000 x 2.125	55	KL 16595 	.375 x 1.125	57	KL 17536 	1.250 x 2.500	59
KL 16552 	.656 x 1.234	55	KL 16596 	1.500 x 2.000	57	KL 17537 	.812 x 1.000	59
KL 16553 	.500 x 1.125	55	KL 16597 	.875 x 3.062	57	KL 17538 	.625 x .875	58
KL 16554 	.281 x 1.500	55	KL 16598 	.812 x 1.250	57	KL 17539 	.625 x 1.875	59
KL 16555 	.531 x .875	55	KL 16599 	.750 x 1.125	57	KL 17540 	.625 x .875	59
KL 16556 	.500 x 1.000	55	KL 17500 	.562 x 1.125	57	KL 17541 	1.156 x 1.125	59
KL 16557 	.875 x 1.500	56	KL 17501 	.375 x .830	55	KL17543 	.938 x 1.500	59
KL 16558 	.594 x .750	55	KL 17502 	.750 x 1.500	57	KL 17544 	1.187 x 1.500	59
KL 16559 	1.625 x 2.125	56	KL 17503 	.812 x 1.312	57	KL 17545 	.750 x 2.312	59
KL 16560 	.780 x 2.625	56	KL 17504 	.250 x .750	55	KL 17546 	1.500 x 2.250	59
KL 16561 	.562 x 1.000	56	KL 17505 	.921 x 1.500	57	KL 17547 	.625 x 1.000	59
KL 16562 	1.687 x 1.625	56	KL 17507 	.750 x 1.750	57	KL 17548 	.938 x .875	59
KL 16565 	.680 x 1.000	56	KL 17508 	2.000 x 2.062	58	KL 17549 	.578 x 1.000	59
KL 16567 	1.000 x 1.500	56	KL 17509 	1.500 x 1.250	57	KL 17550 	.625 x 1.000	59
KL 16568 	.625 x .750	56	KL 17510 	.750 x 1.250	58	KL 17552 	.687 x 1.125	59
KL 16569 	.625 x 1.375	56	KL 17511 	.468 x 1.437	58	KL 17554 	.437 x .625	58
KL16570 	1.375 x 1.812	56	KL 17512 	.687 x 1.750	58	KL 17555 	.750 x 1.250	59
KL 16571 	.672 x 1.562	56	KL 17513 	1.125 x 1.125	58	KL 17556 	.812 x 2.125	60
KL 16572 	1.062 x 1.375	56	KL 17514 	.625 x .750	57	KL 17558 	.312 x 1.000	60
KL 16573 	1.203 x 1.875	56	KL 17515 	.984 x 1.375	58	KL 17561 	1.125 x 1.125	60
KL 16574 	.312 x 1.250	55	KL 17516 	1.312 x 1.000	58	KL 17562 	1.375 x 1.250	60
KL 16575 	.625 x 1.250	56	KL 17517 	.656 x 1.750	58	KL 17563 	1.062 x 1.250	60
KL 16576 	.875 x 1.437	56	KL 17518 	.531 x .875	58	KL 17564 	.750 x 2.000	60
KL 16577 	.625 x 1.250	56	KL 17519 	.437 x .675	56	KL 17565 	.375 x .625	58
KL 16578 	.500 x .500	54	KL 17520 	.750 x 3.937	58	KL 17568 	.375 x .500	57
KL 16579 	1.250 x 4.312	57	KL 17521 	.750 x 2.500	58	KL 17569 	.812 x .750	60
KL 16580 	.438 x .937	54	KL 17523 	.468 x .812	58	KL 17570 	2.031 x 1.750	60
KL 16581 	.531 x 1.875	56	KL 17524 	.750 x .750	58	KL 17571 	2.156 x 2.218	60
KL 16583 	.750 x 2.000	56	KL 17525 	.187 x .750	57	KL 17572 	1.031 x 1.625	60
KL 16584 	.781 x 1.843	56	KL 17526 	.750 x 1.563	58	KL 17573 	.446 x .600	58
KL 16585 	.312 x .406	54	KL 17527 	1.750 x 1.562	58	KL 17574 	.812 x 2.375	60
KL 16586 	.625 x .500	55	KL 17528 	.688 x 2.000	58	KL17575 	.938 x 2.000	60



















































































































Panel Mold

CUSTOM PROFILE TABLE OF CONTENTS

PROFILE	SIZE	PAGE	PROFILE	SIZE	PAGE	PROFILE	SIZE	PAGE
KL 17576 	.375 x .750	58	KL 19524 	.875 x 1.500	62	KL 19568 	1.062 x 4.375	64
KL 17577 	1.312 x 1.125	60	KL 19526 	.375 x 1.000	61	KL 19569 	.937 x 1.797	63
KL 17578 	.750 x 1.000	60	KL 19527 	1.000 x 1.063	62	KL 19570 	.531 x 1.062	63
KL17579 	.625 x .625	59	KL 19528 	1.125 x 1.125	62	KL 19571 	.750 x 1.500	64
KL 17580 	.750 x 1.000	60	KL 19529 	.469 x .812	60	KL 19572 	.500 x .375	61
KL 17581 	1.563 x 1.687	61	KL 19530 	1.062 x .875	62	KL 19573 	.750 x .875	64
KL 17582 	.500 x .781	60	KL 19532 	.562 x .812	62	KL 19574 	.687 x 1.562	64
KL 17584 	1.125 x 2.000	61	KL 19533 	.812 x 2.500	62	KL 19575 	1.312 x 2.396	64
KL 17585 	1.125 x 1.000	61	KL 19534 	.812 x 1.750	62	KL 19576 	.359 x .562	62
KL 17586 	.500 x .750	60	KL 19535 	.562 x 1.625	62	KL 19577 	1.185 x .750	64
KL 17587 	.812 x 1.796	60	KL 19536 	.813 x 1.250	62	KL 19578 	.750 x 1.250	64
KL 17589 	.625 x 1.000	61	KL 19537 	.312 x .812	61	KL 19579 	1.312 x 1.500	64
KL 17590 	.750 x 1.000	61	KL 19538 	1.000 x 1.625	62	KL 19580 	.625 x .750	64
KL 17591 	.562 x .812	60	KL 19539 	.750 x .875	62	KL 19581 	1.094 x 1.968	64
KL 17592 	.625 x .937	61	KL 19540 	.375 x .750	62	KL 19582 	.800 x 1.700	64
KL 17593 	.625 x .875	61	KL 19541 	.688 x 1.500	62	KL 19583 	.750 x 1.093	64
KL 17594 	.750 x .750	61	KL 19542 	.750 x 1.875	62	KL 19584 	.594 x 1.187	64
KL 17596 	.813 x 1.687	61	KL 19543 	.625 x .938	62	KL 19585 	1.750 x 1.062	64
KL 17597 	.938 x .750	61	KL 19544 	.688 x 2.000	62	KL 19588 	1.000 x 1.437	64
KL 17598 	.594 x 1.375	61	KL 19545 	1.500 x 1.062	62	KL 19590 	.500 x .813	64
KL 17599 	1.250 x 1.094	61	KL 19546 	.500 x 1.625	63	KL 19591 	.562 x .812	64
KL 19500 	.812 x 1.312	61	KL 19547 	.375 x .500	60	KL 19592 	1.250 x .875	64
KL 19502 	1.250 x 1.125	61	KL 19548 	1.062 x 1.062	62	KL 19593 	.500 x .500	63
KL 19503 	1.125 x 1.812	61	KL 19549 	.750 x .750	63	KL 19594 	1.250 x 1.250	64
KL 19504 	.438 x .812	60	KL 19550 	.250 x .750	62	KL 19595 	.750 x .938	65
KL 19505 	.437 x 1.375	60	KL 19551 	.750 x 2.000	63	KL 19596 	1.188 x 1.062	65
KL 19506 	.438 x 1.813	61	KL 19552 	1.625 x 1.750	63	KL 19597 	1.000 x 1.250	65
KL 19510 	.250 x .750	58	KL 19553 	1.875 x 2.562	63	KL 19598 	1.000 x 1.875	65
KL 19511 	.500 x 1.250	61	KL 19554 	.750 x 1.875	63	KL 19599 	.750 x 1.187	65
KL 19512 	.938 x 1.500	61	KL 19557 	1.500 x 1.375	63	KL 20500 	.750 x 2.250	65
KL 19514 	.813 x 1.500	61	KL 19558 	.625 x 1.750	63	KL 20501 	.812 x 1.375	65
KL 19515 	1.500 x 1.250	61	KL 19560 	.875 x 1.725	63	KL 20502 	.750 x 1.313	65
KL 19516 	.500 x 1.625	61	KL 19562 	.400 x .900	63	KL 20503 	.750 x 2.125	65
KL 19517 	.563 x .875	61	KL 19563 	.750 x 2.500	63	KL 20504 	.688 x 1.125	65
KL 19518 	.812 x 2.812	62	KL 19564 	.875 x 2.250	63	KL 20505 	.938 x 1.125	65
KL 19520 	.406 x .500	59	KL 19565 	.562 x 1.000	63	KL 20506 	.438 x 1.125	64
KL 19521 	.625 x 1.000	62	KL 19566 	.875 x 2.250	63	KL 20508 	1.250 x 1.250	65
KL 19523 	1.750 x 1.812	62	KL 19567 	.625 x 2.812	63	KL 20510 	.750 x .750	64

















































































































Panel Mold

CUSTOM PROFILE TABLE OF CONTENTS

PROFILE	SIZE	PAGE	PROFILE	SIZE	PAGE	PROFILE	SIZE	PAGE
KL 20511 	1.063 x 1.500	65	KL 20554 	.625 x 2.000	67	KL 21500 	1.500 x 2.250	68
KL 20512 	1.062 x 1.688	65	KL 20556 	1.000 x 1.187	67	KL 21501 	.625 x 1.188	68
KL 20513 	.656 x 1.500	65	KL 20557 	.646 x 2.080	67	KL 21502 	.812 x 1.812	68
KL 20514 	.375 x 1.109	63	KL 20559 	.563 x 1.875	67	KL 21503 	1.375 x 1.625	68
KL 20515 	.750 x .750	65	KL 20561 	.625 x .812	66	KL 21504 	.812 x 1.750	68
KL 20516 	1.438 x 1.188	65	KL 20562 	.500 x .812	66	KL 21505 	1.312 x 1.625	69
KL 20517 	.875 x 1.062	65	KL 20563 	.625 x 1.000	67	KL 21506 	.625 x 2.375	69
KL 20518 	.937 x 1.938	65	KL 20564 	1.500 x 1.875	67	KL 21507 	.480 x .937	69
KL 20520 	.750 x 1.500	65	KL 20565 	.812 x 1.750	67	KL 21508 	.812 x 2.750	69
KL 20521 	1.062 x 2.000	66	KL 20566 	1.062 x .875	67	KL 21509 	.531 x .625	68
KL 20522 	.875 x 1.500	65	KL 20569 	.688 x 1.375	67	KL 21510 	.531 x .750	69
KL 20525 	.375 x .750	65	KL 20570 	.688 x 1.562	67	KL 21511 	.688 x .875	69
KL 20526 	1.000 x 1.312	66	KL 20571 	.750 x 1.500	67	KL 21515 	1.000 x 1.750	69
KL 20527 	.500 x 1.062	65	KL 20573 	.781 x 1.718	67	KL 21519 	.812 x 2.500	69
KL 20528 	.250 x .375	63	KL 20574 	.625 x 1.343	67	KL 21521 	.718 x 1.875	69
KL 20529 	.625 x .875	66	KL 20575 	.875 x 1.500	67	KL 21522 	.812 x 2.250	69
KL 20531 	.375 x .562	65	KL 20576 	.812 x 2.281	67	KL 21523 	1.500 x 1.125	69
KL 20532 	.688 x 1.187	66	KL 20577 	1.000 x 1.187	67	KL 21524 	.750 x 1.500	69
KL 20534 	.562 x 1.687	66	KL 20578 	.406 x .718	67	KL 21527 	.750 x 2.000	69
KL 20535 	.812 x 2.375	66	KL 20579 	.500 x .750	67	KL 21528 	1.437 x 2.000	69
KL 20536 	1.062 x 1.500	66	KL 20580 	.812 x 1.688	67	KL 21529 	.750 x .938	69
KL 20537 	.375 x 1.250	66	KL 20581 	.578 x .812	67	KL 21531 	.500 x 1.125	69
KL 20538 	1.125 x 2.250	66	KL 20584 	.500 x .593	67	KL 21532 	.750 x 2.000	69
KL 20539 	.625 x 1.156	66	KL 20585 	1.062 x 2.250	68	KL 21533 	.750 x 1.250	69
KL 20540 	1.187 x .812	66	KL 20586 	1.125 x .812	68	KL 21534 	1.500 x .875	69
KL 20541 	.813 x 1.375	66	KL 20587 	.625 x .750	68	KL 21535 	1.750 x 2.062	70
KL 20542 	.625 x 1.250	66	KL 20588 	.750 x 1.500	68	KL 21537 	.625 x 1.062	69
KL 20543 	.563 x 2.000	66	KL 20589 	1.125 x 2.750	68	KL 21538 	.650 x 1.750	69
KL 20544 	.625 x .750	66	KL 20590 	.750 x 2.750	68	KL 21539 	.813 x 1.000	70
KL 20545 	.469 x 1.250	66	KL 20591 	.750 x 1.375	68	KL 21540 	.750 x 1.375	70
KL20546 	.750 x .938	66	KL 20592 	.531 x 1.625	68	KL 21541 	.750 x 1.187	70
KL 20547 	.500 x 1.063	66	KL 20593 	.938 x .875	68	KL 21542 	.218 x .500	67
KL 20548 	1.375 x 1.250	66	KL 20594 	.812 x 1.188	68	KL 21543 	1.000 x 1.562	70
KL 20549 	.500 x 1.157	66	KL 20595 	.562 x .875	68	KL 21544 	.688 x 1.812	70
KL 20550 	.750 x 1.688	66	KL 20596 	1.500 x 1.031	68	KL 21545 	.688 x 1.500	70
KL 20551 	.562 x .750	66	KL 20597 	.305 x .750	67	KL 21546 	.687 x 1.000	70
KL 20552 	.900 x 1.375	67	KL 20598 	.320 x .750	68	KL 21547 	1.000 x 1.500	70
KL 20553 	.625 x .750	66	KL 20599 	1.000 x 2.000	68	KL 21548 	.562 x 1.125	70













































































































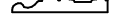





Panel Mold

CUSTOM PROFILE TABLE OF CONTENTS

PROFILE	SIZE	PAGE	PROFILE	SIZE	PAGE	PROFILE	SIZE	PAGE
KL 21549 	1.203 x .859	70	KL 21588 	.375 x 1.312	72	KL 23534 	.375 x .968	73
KL 21550 	1.000 x 1.500	70	KL 21589 	.375 x 1.312	72	KL 23535 	.500 x .875	74
KL 21551 	.375 x .875	70	KL 21590 	.625 x .625	72	KL 23536 	1.375 x 2.125	74
KL 21553 	1.750 x 3.125	70	KL 21591 	.812 x 2.250	72	KL 23537 	1.000 x 1.250	74
KL 21554 	.688 x 2.125	70	KL 21592 	.875 x 2.750	72	KL 23538 	.977 x 1.812	74
KL 21555 	1.125 x .875	70	KL 21593 	.938 x 3.187	72	KL 23539 	.389 x .812	73
KL 21556 	.688 x 1.000	70	KL 21594 	.540 x 1.000	72	KL 23540 	.812 x 1.000	74
KL 21557 	.938 x 2.812	71	KL 21595 	.625 x 1.625	72	KL 23541 	.595 x 1.531	74
KL 21558 	2.250 x 3.188	71	KL 21596 	.656 x 1.438	72	KL 23542 	1.062 x 1.875	74
KL 21559 	.312 x .500	70	KL 21598 	.750 x 1.188	72	KL 23544 	.750 x 1.750	74
KL 21560 	.812 x 2.312	70	KL 21599 	.250 x .688	72	KL 23545 	1.000 x 2.125	74
KL 21561 	.625 x 1.250	71	KL 23500 	.750 x 1.875	72	KL 23548 	2.000 x 2.500	74
KL 21562 	.812 x 2.562	71	KL 23502 	.906 x 1.625	72	KL 23549 	.250 x 2.250	74
KL 21563 	.940 x 2.687	71	KL 23503 	.625 x 1.375	72	KL 23550 	1.156 x 1.125	74
KL 21564 	.563 x .750	70	KL 23504 	.500 x .500	70	KL 23551 	.750 x 2.000	74
KL 21565 	.562 x .750	70	KL 23506 	1.125 x 1.125	72	KL 23552 	1.625 x 2.250	75
KL 21566 	.812 x 1.750	71	KL 23507 	1.031 x 2.125	73	KL 23554 	.500 x 1.000	74
KL 21567 	.500 x .750	70	KL 23508 	.566 x .750	73	KL 23555 	.875 x 1.375	74
KL 21568 	.905 x 1.500	71	KL 23509 	1.125 x 1.500	73	KL 23556 	1.531 x 1.062	74
KL 21569 	.812 x 1.000	71	KL 23511 	.345 x .875	72	KL 23557 	.312 x .562	73
KL 21570 	.875 x 2.000	71	KL 23512 	.438 x 1.500	73	KL 23558 	1.562 x 1.938	75
KL 21571 	.500 x 1.750	71	KL 23514 	.437 x 1.125	73	KL 23560 	.625 x .938	75
KL 21572 	.562 x .812	71	KL 23515 	.625 x .750	73	KL 23561 	.750 x .814	75
KL 21573 	1.000 x 1.750	71	KL 23516 	1.625 x 1.125	73	KL 23562 	.438 x 1.000	75
KL 21574 	.627 x .750	71	KL 23517 	.750 x 1.000	73	KL 23563 	.500 x .875	75
KL 21575 	.812 x 1.312	71	KL 23518 	1.312 x 1.062	73	KL 23564 	.812 x 1.750	75
KL 21576 	.500 x 1.000	71	KL 23519 	1.250 x 1.812	73	KL 23565 	.438 x 1.062	75
KL 21577 	1.250 x 1.219	71	KL 23520 	1.063 x 2.000	73	KL 23566 	.625 x .750	74
KL 21578 	.438 x .750	71	KL 23521 	.688 x 1.750	73	KL 23567 	.312 x .625	73
KL 21579 	1.313 x 2.469	72	KL 23523 	.594 x .812	73	KL 23568 	.453 x 1.000	75
KL 21580 	.250 x .750	70	KL 23524 	.688 x 1.562	73	KL 23570 	.500 x 2.000	75
KL 21581 	.781 x 1.281	71	KL 23525 	.875 x 1.688	73	KL 23571 	.230 x .515	73
KL 21582 	1.000 x 1.000	71	KL 23526 	.625 x 1.000	73	KL 23572 	.625 x 2.000	75
KL 21583 	.468 x .750	71	KL 23529 	1.250 x 2.250	73	KL 23574 	.594 x 1.060	75
KL 21584 	.875 x 1.500	72	KL 23530 	.625 x 1.062	73	KL 23575 	.935 x 1.500	75
KL 21585 	.430 x .875	72	KL 23531 	.500 x 2.250	73	KL 23578 	.312 x .562	74
KL 21586 	.656 x 2.000	72	KL 23532 	.812 x 2.531	74	KL 23579 	.750 x 1.125	75
KL 21587 	.625 x 1.125	72	KL 23533 	.688 x 1.375	73	KL 23580 	1.000 x 1.500	75



















































































































Panel Mold

CUSTOM PROFILE TABLE OF CONTENTS

PROFILE	SIZE	PAGE	PROFILE	SIZE	PAGE	PROFILE	SIZE	PAGE
KL 23581 	.312 x .625	75	KL 24527 	.625 x 1.375	77	KL 24573 	1.250 x 1.750	79
KL 23582 	.906 x 1.375	75	KL 24528 	.469 x .750	76	KL 24574 	.562 x 1.375	79
KL 23584 	.750 x .938	75	KL 24529 	.688 x 1.000	77	KL 24575 	1.062 x 1.750	79
KL 23585 	.468 x 1.141	75	KL 24530 	.687 x 1.062	77	KL 24576 	.750 x 2.062	79
KL 23586 	.625 x 1.304	75	KL 24531 	.765 x 1.062	77	KL 24577 	.625 x 1.250	79
KL 23587 	.625 x 1.187	75	KL 24532 	1.094 x 2.905	77	KL 24578 	.198 x .500	77
KL 23588 	.625 x .750	75	KL 24533 	.687 x 1.250	77	KL 24579 	1.438 x 2.000	79
KL 23589 	.312 x .500	73	KL 24534 	1.562 x 1.250	77	KL 24580 	1.000 x 1.000	79
KL 23590 	.688 x 2.281	75	KL 24535 	.625 x .750	77	KL 24581 	1.750 x 1.375	79
KL 23592 	1.000 x 1.750	76	KL 24536 	.250 x .375	74	KL 24582 	1.187 x 1.812	79
KL 23593 	2.000 x 4.250	76	KL 24537 	.688 x 1.312	77	KL 24583 	.500 x 1.500	78
KL 23594 	1.531 x 1.312	76	KL 24538 	.563 x .938	77	KL 24584 	.438 x .688	79
KL 23595 	.375 x 1.000	75	KL 24539 	.781 x 2.375	77	KL 24585 	.750 x 1.375	79
KL 23596 	2.000 x 1.625	76	KL 24540 	1.000 x 3.500	78	KL 24586 	.625 x 1.188	79
KL 24501 	.875 x 1.875	76	KL 24542 	.725 x 1.570	77	KL 24587 	.750 x 2.281	80
KL 24502 	1.187 x 1.437	76	KL 24543 	.500 x .750	77	KL 24588 	.875 x 2.937	80
KL 24504 	.375 x 1.000	75	KL 24546 	.937 x 2.250	78	KL 24589 	.750 x .938	80
KL 24505 	.562 x .688	75	KL 24547 	.812 x 1.500	78	KL 24590 	1.125 x 1.719	80
KL 24506 	.250 x 1.250	75	KL 24548 	.625 x 1.625	78	KL 24591 	.812 x 1.812	80
KL 24507 	.531 x .563	75	KL 24550 	.562 x .750	77	KL 24592 	.812 x 1.750	80
KL 24508 	.781 x 1.812	76	KL 24551 	.451 x .703	78	KL 24593 	.437 x .812	79
KL 24509 	.812 x 1.375	76	KL 24552 	1.375 x 1.500	78	KL 24594 	.359 x .500	78
KL 24510 	.375 x .750	76	KL 24553 	.500 x .750	78	KL 24596 	.625 x 1.493	80
KL 24511 	.750 x 1.312	76	KL 24554 	.750 x 1.531	78	KL 24597 	.625 x 1.375	79
KL 24512 	.812 x 1.812	76	KL 24555 	.812 x 2.125	78	KL 24598 	.375 x .937	79
KL 24513 	.625 x .719	76	KL 24556 	.848 x 1.000	78	KL 24599 	.812 x 1.750	80
KL 24514 	1.000 x 2.500	76	KL 24558 	1.687 x 2.438	78	KL 25500 	2.437 x 1.687	80
KL 24516 	.750 x 1.500	76	KL 24559 	1.625 x 2.000	78	KL 25501 	.406 x 3.125	80
KL 24517 	.625 x .875	76	KL 24560 	.841 x 1.500	78	KL 25502 	1.000 x 2.500	80
KL 24518 	1.062 x .781	77	KL 24561 	.625 x 1.250	78	KL 25503 	.562 x .875	80
KL 24519 	.812 x 1.281	77	KL 24562 	.437 x .750	78	KL 25504 	1.125 x 1.125	80
KL 24520 	.750 x 2.000	77	KL 24563 	1.500 x 1.750	78	KL 25505 	.688 x 1.375	80
KL 24521 	1.125 x 3.562	77	KL 24564 	.750 x 1.500	78	KL 25506 	.750 x 4.000	80
KL 24522 	1.219 x 1.438	77	KL 24565 	.706 x 1.875	79	KL 25507 	.406 x .625	79
KL 24523 	.750 x 2.625	77	KL 24569 	.812 x 2.938	79	KL 25508 	.500 x .875	80
KL 24524 	.687 x 1.250	76	KL 24570 	1.188 x .812	79	KL 25509 	.594 x 1.297	80
KL 24525 	1.000 x .812	77	KL 24571 	1.344 x 2.250	79	KL 25510 	.906 x 1.625	81
KL 24526 	.625 x 1.125	77	KL 24572 	.625 x 1.312	79	KL 25511 	1.250 x .750	80

















































































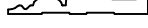

































Panel Mold

CUSTOM PROFILE TABLE OF CONTENTS

PROFILE	SIZE	PAGE	PROFILE	SIZE	PAGE	PROFILE	SIZE	PAGE
KL 25512 	.500 x .469	80	KL 25553 	.438 x 1.625	82	KL 25599 	.781 x 2.000	84
KL 25513 	.469 x .844	80	KL 25554 	1.302 x .875	83	KL 26500 	.284 x .619	84
KL 25514 	.875 x 2.000	81	KL 25556 	.625 x .718	82	KL 26501 	1.750 x 2.125	84
KL 25515 	.718 x 1.406	81	KL 25558 	.500 x 1.500	83	KL 26502 	.500 x 1.250	84
KL 25516 	1.031 x .968	81	KL 25559 	.500 x .750	82	KL 26503 	.688 x 1.500	84
KL 25518 	.719 x 1.875	81	KL 25560 	1.125 x 2.000	83	KL 26504 	.688 x 1.125	84
KL 25519 	1.281 x 2.500	81	KL 25561 	.812 x 1.562	83	KL 26506 	.438 x .750	84
KL 25520 	.750 x 2.219	81	KL 25562 	1.000 x 1.750	83	KL 26507 	.438 x 1.125	84
KL 25521 	1.125 x 2.312	81	KL 25563 	.750 x 1.000	83	KL 26508 	1.250 x 1.750	84
KL 25522 	.812 x 1.688	81	KL 25564 	.938 x 1.250	83	KL 26509 	.875 x 1.500	84
KL 25523 	.812 x 2.125	81	KL 25565 	1.250 x 1.625	83	KL 26510 	1.750 x 2.250	85
KL 25524 	.750 x .750	81	KL 25566 	1.250 x 2.000	83	KL 26511 	1.093 x 1.593	84
KL 25525 	.687 x 1.500	81	KL 25567 	.625 x .687	83	KL 26512 	.593 x 1.250	85
KL 25526 	.656 x 1.969	81	KL 25568 	.375 x 1.000	82	KL 26513 	.781 x 1.750	85
KL 25528 	.750 x 1.000	81	KL 25569 	1.062 x .719	83	KL 26514 	.562 x .781	84
KL 25529 	.625 x 1.625	81	KL 25570 	.750 x 1.562	83	KL 26515 	1.062 x 2.500	85
KL 25530 	1.500 x 1.750	81	KL 25571 	.562 x 1.218	83	KL 26516 	.875 x 3.000	85
KL 25531 	.656 x 1.406	81	KL 25572 	1.062 x 1.062	83	KL 26517 	.437 x .750	84
KL 25532 	.562 x 2.688	82	KL 25573 	.879 x 1.062	83	KL 26518 	.625 x 1.625	85
KL 25533 	.500 x 1.062	81	KL 25574 	.500 x 1.125	83	KL 26519 	1.312 x 2.625	85
KL 25534 	1.485 x 3.500	82	KL 25575 	1.031 x 1.531	83	KL 26522 	1.000 x 5.500	85
KL 25535 	.750 x 1.750	82	KL 25576 	.687 x 1.062	83	KL 26523 	.500 x .875	85
KL 25536 	.750 x 1.000	81	KL 25577 	.750 x 1.750	83	KL 26524 	.625 x 2.188	85
KL 25537 	1.625 x 4.093	82	KL 25578 	.500 x 1.187	83	KL 26525 	.625 x 2.000	85
KL 25538 	1.000 x 1.750	82	KL 25579 	.328 x 1.281	83	KL 26526 	.250 x .500	82
KL 25539 	.906 x 1.125	82	KL 25581 	.812 x 1.281	83	KL 26527 	.625 x 1.375	85
KL 25540 	.687 x .875	82	KL 25582 	.750 x .937	84	KL 26528 	.625 x .750	85
KL 25541 	.687 x 1.750	82	KL 25585 	.844 x .875	84	KL 26529 	.750 x 1.500	86
KL 25542 	.718 x 1.625	82	KL 25586 	.500 x 1.438	84	KL 26530 	.875 x 1.500	86
KL 25543 	.812 x 1.750	82	KL 25587 	.750 x .750	84	KL 26531 	1.125 x 1.875	86
KL 25544 	.687 x 1.250	82	KL 25588 	.484 x .750	84	KL 26532 	1.000 x 1.063	86
KL 25545 	.500 x .875	82	KL 25589 	.500 x 1.000	84	KL 26533 	.500 x 1.250	86
KL 25546 	1.125 x 1.250	82	KL 25590 	.781 x 1.094	84	KL 26534 	.562 x 1.500	86
KL 25547 	.750 x 1.000	82	KL 25591 	.781 x 1.094	84	KL 26535 	.750 x 1.625	86
KL 25549 	1.375 x .875	82	KL 25593 	1.062 x 1.000	84	KL 26536 	.750 x 1.750	86
KL 25550 	.468 x .531	81	KL 25594 	.562 x 1.468	84	KL 26537 	.500 x .875	86
KL 25551 	.750 x 2.000	83	KL 25595 	.656 x 1.500	84	KL 26538 	.796 x 1.890	86
KL 25552 	.437 x 1.250	82	KL 25598 	1.000 x 1.250	84	KL 26539 	.750 x .720	86



















































































































Panel Mold

CUSTOM PROFILE TABLE OF CONTENTS

PROFILE	SIZE	PAGE	PROFILE	SIZE	PAGE	PROFILE	SIZE	PAGE
KL 26540 	1.062 x 1.375	86	KL 26583 	1.188 x 2.437	88	KL 27527 	1.062 x 1.062	90
KL 26541 	1.375 x 2.875	86	KL 26584 	.812 x 2.000	88	KL 27528 	1.094 x 1.750	90
KL 26542 	1.500 x 1.500	86	KL 26585 	.625 x .500	86	KL 27529 	.625 x 1.125	89
KL 26543 	.844 x 1.875	86	KL 26586 	1.875 x 2.000	88	KL 27531 	.703 x 2.312	90
KL 26544 	1.250 x 2.813	86	KL 26587 	.688 x 2.875	88	KL 27532 	.750 x 2.000	90
KL 26546 	.875 x 1.625	86	KL 26588 	1.500 x 1.500	88	KL 27533 	.937 x 1.500	90
KL 26548 	.812 x 1.500	87	KL 26589 	.500 x .375	85	KL 27534 	1.062 x 3.250	90
KL 26549 	.875 x 1.500	87	KL 26590 	.625 x 1.063	88	KL 27535 	1.250 x 1.562	90
KL 26550 	.600 x 1.250	86	KL 26591 	.250 x .313	85	KL 27536 	.500 x 1.125	89
KL 26551 	.625 x 1.812	87	KL 26594 	.375 x 1.250	86	KL 27537 	.250 x .750	87
KL 26552 	.750 x 1.750	87	KL 26595 	1.218 x 1.125	88	KL 27538 	1.000 x 2.187	90
KL 26553 	1.000 x 2.000	87	KL 26596 	.750 x 1.140	88	KL 27539 	.375 x .938	87
KL 26554 	.394 x .625	85	KL 26597 	.875 x 1.562	89	KL 27540 	1.375 x .750	90
KL 26555 	1.250 x 2.250	87	KL 26598 	1.625 x 2.250	89	KL 27541 	.500 x .625	88
KL 26556 	1.438 x 1.438	87	KL 26599 	1.125 x 1.000	89	KL 27542 	.750 x 1.625	90
KL 26557 	.500 x 1.000	87	KL 27500 	.938 x .500	89	KL 27543 	1.375 x 3.000	91
KL 26558 	1.250 x 1.500	87	KL 27501 	.750 x 1.875	89	KL 27544 	1.875 x 4.000	91
KL 26561 	.735 x 1.500	87	KL 27502 	.562 x 1.812	89	KL 27545 	.875 x 1.500	90
KL 26562 	.650 x 1.500	87	KL 27505 	.688 x 1.125	89	KL 27546 	.813 x 1.500	91
KL 26563 	1.062 x 2.125	87	KL 27506 	.375 x .688	86	KL 27547 	1.000 x 1.781	91
KL 26565 	.391 x .750	85	KL 27507 	.296 x .750	87	KL 27548 	.625 x 1.000	91
KL 26566 	1.250 x 1.062	87	KL 27508 	1.000 x 1.330	89	KL 27549 	.687 x 1.688	91
KL 26567 	.625 x .968	87	KL 27510 	.438 x 1.000	88	KL 27550 	1.250 x 3.343	91
KL 26568 	1.750 x 1.437	87	KL 27511 	.750 x 5.875	89	KL 27551 	.738 x 2.000	91
KL 26569 	1.250 x 1.375	87	KL 27512 	2.125 x 1.250	90	KL 27552 	.600 x 2.312	91
KL 26570 	.813 x 2.187	87	KL 27513 	.562 x 1.000	89	KL 27553 	.625 x 1.125	91
KL 26571 	2.000 x 1.250	88	KL 27514 	.562 x 1.562	89	KL 27554 	.906 x 1.875	91
KL 26572 	.625 x 1.375	87	KL 27515 	.875 x 2.062	89	KL 27555 	.625 x 1.063	91
KL 26573 	.688 x 1.750	88	KL 27516 	1.125 x 1.625	89	KL 27557 	.500 x .750	91
KL 26574 	.250 x 1.000	85	KL 27517 	.656 x .843	89	KL 27558 	.813 x 1.875	91
KL 26575 	.730 x 1.062	88	KL 27518 	.687 x 1.500	89	KL 27559 	.312 x .500	88
KL 26576 	.750 x 1.625	88	KL 27519 	.750 x 1.750	89	KL 27560 	1.062 x 1.375	91
KL 26577 	.500 x .938	88	KL 27520 	1.375 x 1.500	90	KL 27562 	1.000 x 1.000	92
KL 26578 	.375 x 1.125	85	KL 27521 	.750 x 1.500	90	KL 27563 	.250 x .750	90
KL 26579 	1.688 x 1.328	88	KL 27522 	.500 x 1.250	89	KL 27564 	.812 x 2.188	92
KL 26580 	.937 x 1.984	88	KL 27523 	1.000 x 1.000	90	KL 27565 	.750 x 1.750	92
KL 26581 	1.000 x 1.593	88	KL 27525 	1.125 x 1.000	90	KL 27566 	.812 x 1.375	92
KL 26582 	.562 x .750	88	KL 27526 	.562 x .812	89	KL 27567 	.563 x .813	91















































































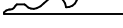

































Panel Mold

CUSTOM PROFILE TABLE OF CONTENTS

PROFILE	SIZE	PAGE	PROFILE	SIZE	PAGE	PROFILE	SIZE	PAGE
KL 27568 	.438 x .625	90	KL 29511 	1.250 x 1.516	93	KL 29553 	.875 x 2.125	96
KL 27569 	1.750 x 1.375	92	KL 29512 	.871 x 2.062	93	KL 29554 	1.250 x 1.625	96
KL 27570 	.625 x .750	91	KL 29513 	.719 x 1.344	93	KL 29555 	.875 x .750	95
KL 27571 	.375 x .625	90	KL 29514 	.456 x .750	93	KL 29556 	1.770 x 1.153	96
KL 27573 	.750 x 1.500	92	KL 29515 	.781 x 1.734	94	KL 29557 	1.041 x 1.750	96
KL 27574 	.562 x 1.000	92	KL 29516 	1.188 x 1.094	94	KL 29558 	1.000 x 2.750	96
KL 27575 	.563 x 2.250	92	KL 29517 	1.375 x 1.250	94	KL 29559 	1.125 x .750	96
KL 27576 	.625 x .687		KL 29518 	.843 x 1.750	94	KL 29560 	.750 x 1.750	96
KL 27577 	.625 x .875	92	KL 29519 	1.468 x 1.219	94	KL 29561 	1.062 x .875	96
KL 27578 	.375 x .375	90	KL 29520 	.420 x 1.000	93	KL 29562 	.688 x 1.250	96
KL 27579 	.875 x 1.250	92	KL 29522 	.500 x .500	93	KL 29563 	.844 x 2.094	96
KL 27580 	.406 x .750	92	KL 29523 	.688 x 2.093	94	KL 29564 	1.719 x 2.956	96
KL 27581 	.734 x 1.719	92	KL 29524 	1.125 x 1.312	94	KL 29565 	1.063 x 2.875	97
KL 27582 	.563 x 1.125	92	KL 29525 	.500 x .779	94	KL 29566 	1.219 x 1.625	96
KL 27583 	.687 x .938	92	KL 29526 	.688 x 1.688	94	KL 29567 	1.625 x 4.000	97
KL 27587 	1.125 x 1.000	92	KL 29527 	1.625 x 1.906	94	KL 29568 	.500 x 1.375	96
KL 27588 	.375 x .562	91	KL 29528 	.750 x 1.625	94	KL 29569 	.812 x 2.406	97
KL 27590 	.500 x 1.875	92	KL 29529 	.828 x 2.000	94	KL 29570 	.844 x 2.438	97
KL 27591 	.656 x 1.250	92	KL 29530 	.875 x 2.000	94	KL 29571 	.625 x 1.250	96
KL 27592 	1.177 x 1.563	92	KL 29531 	.781 x 2.469	94	KL 29572 	.813 x 1.750	97
KL 27593 	.687 x .875	92	KL 29532 	1.250 x 1.031	94	KL 29573 	1.500 x 2.438	97
KL 27594 	.813 x 1.969	92	KL 29533 	.438 x .750	94	KL 29575 	.875 x 1.500	97
KL 27595 	1.125 x 1.875	92	KL 29534 	.563 x 1.988	94	KL 29576 	.875 x .750	96
KL 27596 	1.062 x 1.956	93	KL 29535 	1.000 x 1.500	94	KL 29577 	1.313 x 1.125	97
KL 27597 	.875 x 1.000	93	KL 29536 	.812 x 1.313	95	KL 29580 	.828 x 2.000	97
KL 27598 	.813 x 2.656	93	KL 29537 	1.484 x 1.500	95	KL 29581 	1.287 x 1.500	97
KL 27599 	.750 x 1.500	93	KL 29538 	2.654 x 3.000	95	KL 29582 	1.000 x .969	97
KL 29500 	.844 x 3.000	93	KL 29540 	.688 x .875	94	KL 29583 	.750 x .969	97
KL 29501 	.656 x .750	93	KL 29541 	.625 x .813	95	KL 29585 	1.094 x .938	98
KL 29502 	.750 x 1.750	93	KL 29542 	1.094 x .938	95	KL 29586 	.797 x 1.344	97
KL 29503 	.563 x .750	93	KL 29543 	.766 x 1.188	95	KL 29587 	.640 x 1.031	97
KL 29504 	.891 x 2.125	93	KL 29544 	.875 x 1.500	95	KL 29588 	.688 x 1.187	98
KL 29505 	.687 x 2.000	93	KL 29545 	1.281 x 2.438	95	KL 29589 	.688 x .875	97
KL 29506 	.562 x 1.250	93	KL 29546 	1.438 x 2.188	95	KL 29590 	.656 x 1.578	98
KL 29507 	.844 x 1.594	93	KL 29547 	.750 x 1.484	95	KL 29591 	.750 x 1.625	98
KL 29508 	.375 x .750	93	KL 29550 	.813 x 3.000	95	KL 29592 	.625 x 1.234	98
KL 29509 	1.812 x 1.500	93	KL 29551 	1.062 x 3.193	95	KL 29593 	.500 x .813	98
KL 29510 	.797 x 2.031	93	KL 29552 	.750 x 1.625	96	KL 29594 	.250 x .750	95



























































































Panel Mold

CUSTOM PROFILE TABLE OF CONTENTS

PROFILE	SIZE	PAGE	PROFILE	SIZE	PAGE	PROFILE	SIZE	PAGE
KL 29595 	1.156 x 2.313	98	KL 30555 	.648 x 1.359	100	KL 31501 	.500 x 1.500	101
KL 29598 	.484 x .723	97	KL 30556 	.625 x 1.250	100	KL 31502 	1.500 x 1.500	101
KL 29599 	.726 x 1.000	98	KL 30559 	1.062 x 1.000	100	KL 31507 	.500 x .915	101
KL 30500 	.781 x 2.969	98	KL 30560 	.734 x .969	99	KL 31508 	.270 x .625	98
KL 30504 	.812 x 3.062	98	KL 30562 	.625 x .625	98	KL 31509 	.766 x 2.000	101
KL 30505 	.703 x 1.250	98	KL 30565 	1.000 x 1.000	100	KL 31510 	.615 x 1.000	101
KL 30506 	1.375 x 1.406	98	KL 30566 	.844 x 2.609	100	KL 31511 	.563 x .906	102
KL 30508 	.370 x .359	95	KL 30567 	.516 x .727	100	KL 31512 	.500 x .781	102
KL 30510 	.750 x 2.250	98	KL 30568 	1.000 x 1.297	100	KL 31513 	.781 x 2.333	102
KL 30512 	.625 x 2.000	98	KL 30569 	.781 x 1.797	100	KL 31515 	1.250 x 2.000	102
KL 30513 	1.000 x .729	98	KL 30570 	1.375 x 1.750	100	KL 31517 	1.375 x 2.000	102
KL 30514 	1.094 x 1.156	98	KL 30571 	1.000 x 2.937	100	KL 31518 	.750 x 2.000	102
KL 30515 	1.234 x .750	98	KL 30572 	.750 x 1.375	100	KL 31519 	.531 x 1.906	102
KL 30516 	1.875 x 2.500	99	KL 30573 	1.000 x 1.000	100	KL 31520 	.641 x 1.000	102
KL 30517 	.828 x 1.891	99	KL 30574 	.625 x 1.250	100	KL 31521 	.516 x 1.266	102
KL 30518 	.859 x 2.375	99	KL 30575 	.781 x 2.250	100	KL 31522 	1.047 x 1.500	102
KL 30520 	1.000 x .875	98	KL 30576 	.796 x 1.203	100	KL 31523 	.500 x 1.000	102
KL 30521 	.703 x 1.656	99	KL 30577 	1.062 x 1.797	100	KL 31525 	1.141 x 1.938	102
KL 30523 	.438 x .609	96	KL 30578 	.750 x 1.375	101	KL 31526 	.910 x 1.500	102
KL 30524 	.782 x 1.484	96	KL 30579 	1.250 x 1.563	101	KL 31527 	.500 x 1.750	102
KL 30525 	.828 x 1.969	99	KL 30580 	.500 x 1.688	101	KL 31528 	.937 x 1.500	102
KL 30530 	1.062 x 4.547	99	KL 30581 	.750 x .750	100	KL 31530 	1.375 x 1.125	102
KL 30531 	.812 x 1.313	96	KL 30582 	.750 x 1.250	101	KL 31531 	1.062 x 2.000	102
KL 30532 	.781 x 5.406	99	KL 30583 	.937 x 1.500	101	KL 31532 	.375 x 1.000	102
KL 30535 	1.250 x 1.000	99	KL 30585 	.531 x 1.062	101	KL 31533 	.587 x 1.471	102
KL 30536 	.875 x .875	98	KL 30586 	.469 x 1.313	101	KL 31534 	1.062 x 1.672	103
KL 30537 	1.391 x 1.250	99	KL 30587 	.375 x 1.000	101	KL 31536 	.391 x 1.063	102
KL 30538 	.875 x 1.000	99	KL 30588 	.828 x 1.750	101	KL 31537 	1.000 x 1.906	103
KL 30541 	1.500 x 1.500	100	KL 30590 	.500 x 1.500	101	KL 31539 	1.000 x 1.500	103
KL 30542 	1.375 x 1.250	100	KL 30591 	.750 x 1.000	101	KL 31540 	.500 x 1.516	102
KL 30543 	.878 x 1.832	99	KL 30592 	.600 x .687	101	KL 31541 	1.531 x 1.922	103
KL 30544 	.375 x .750	97	KL 30593 	.438 x 1.406	101	KL 31542 	.531 x 1.547	103
KL 30545 	.563 x .492	97	KL 30594 	.656 x 1.641	101	KL 31543 	.813 x 2.469	103
KL 30550 	.375 x .500	97	KL 30595 	.540 x .438	100	KL 31544 	.625 x 4.000	103
KL 30551 	1.063 x 1.875	100	KL 30596 	.812 x 2.313	101	KL 31545 	.797 x 1.563	103
KL 30552 	.750 x 1.402	99	KL 30597 	.510 x 1.487	101	KL 31546 	.719 x 1.953	103
KL 30553 	.601 x .902	98	KL 30598 	1.000 x 2.062	101	KL 31547 	.953 x 1.688	103
KL 30554 	.492 x 1.146	99	KL 30599 	.938 x 2.375	101	KL 31548 	.859 x 2.094	103

Panel Mold

CUSTOM PROFILE TABLE OF CONTENTS

PROFILE	SIZE	PAGE	PROFILE	SIZE	PAGE	PROFILE	SIZE	PAGE
KL 31549 	.625 x 1.812	103	KL 31597 	.375 x .938	104	KL 33550 	.500 x 3.000	106
KL 31550 	.406 x .500	101	KL 31598 	.375 x .500	102	KL 33551 	.922 x .953	106
KL 31551 	1.195 x .750	103	KL 31599 	.625 x 1.000	105	KL 33552 	.781 x .984	107
KL 31552 	.625 x 1.500	103	KL 33500 	.938 x 1.000	105	KL 33553 	.750 x .930	107
KL 31553 	1.250 x .875	103	KL 33501 	.375 x .625	104	KL 33554 	.875 x 1.734	107
KL 31554 	.500 x .750	102	KL 33502 	.844 x 1.781	105	KL 33555 	.859 x 2.563	107
KL 31555 	.738 x 2.297	103	KL 33504 	.922 x 2.469	105	KL 33557 	.359 x .734	107
KL 31556 	.594 x 1.281	102	KL 33505 	.750 x 1.266	105	KL 33558 	.625 x .938	107
KL 31557 	.719 x 1.875	103	KL 33506 	.797 x 1.750	105	KL 33559 	.625 x .735	107
KL 31558 	.906 x 2.359	104	KL 33507 	.813 x 1.812	105	KL 33560 	1.125 x 1.542	107
KL 31559 	1.094 x 2.031	104	KL 33508 	.946 x .875	105	KL 33561 	1.750 x 2.125	107
KL 31560 	.719 x 1.438	104	KL 33509 	.375 x 1.500	105	KL 33562 	.734 x 2.469	107
KL 31561 	.672 x 1.652	104	KL 33510 	1.375 x 1.625	105	KL 33563 	.625 x .750	107
KL 31563 	.781 x 2.250	104	KL 33511 	.625 x 1.250	105	KL 33564 	.750 x 2.000	107
KL 31564 	.500 x .844	103	KL 33512 	.736 x .938	105			
KL 31565 	.594 x 2.563	104	KL 33513 	.725 x 1.313	106			
KL 31567 	.844 x 1.188	104	KL 33514 	.750 x 1.333	106			
KL 31568 	1.250 x 2.000	104	KL 33515 	.781 x 2.219	106			
KL 31569 	.625 x 1.531	104	KL 33516 	.625 x 1.625	106			
KL 31570 	1.218 x .843	104	KL 33517 	1.094 x 1.953	106			
KL 31571 	.875 x .875	104	KL 33518 	1.188 x 2.891	106			
KL 31575 	.375 x 1.000	104	KL 33520 	1.219 x 1.375	106			
KL 31577 	1.250 x 1.625	104	KL 33522 	.371 x .868	105			
KL 31578 	.812 x 1.547	104	KL 33523 	.375 x .625	105			
KL 31579 	.781 x 1.750	104	KL 33524 	.625 x .930	106			
KL 31582 	.766 x 1.500	104	KL 33525 	.371 x .499	103			
KL 31583 	.875 x 1.750	104	KL 33526 	.750 x .930	106			
KL 31584 	.638 x 1.407	104	KL 33527 	1.796 x 1.625	106			
KL 31585 	.844 x 2.093	105	KL 33532 	.766 x 1.187	106			
KL 31586 	.500 x 1.750	104	KL 33533 	1.250 x 1.250	106			
KL 31587 	.556 x 1.218	105	KL 33534 	.614 x 1.203	106			
KL 31588 	1.313 x 2.375	105	KL 33535 	.500 x .930	106			
KL 31589 	.484 x 1.031	105	KL 33537 	.975 x 2.406	106			
KL 31590 	.625 x 1.375	105	KL 33541 	.735 x .938	106			
KL 31593 	.625 x 1.125	105	KL 33542 	.930 x .938	106			
KL 31594 	.375 x 1.000	104	KL 33545 	.500 x .930	106			
KL 31595 	1.375 x 2.453	105	KL 33548 	1.094 x .719	106			
KL 31596 	1.000 x .750	105	KL 33549 	.885 x 1.850	107			



KL 501
.375 x .625



KL 506
.562 x 1.375

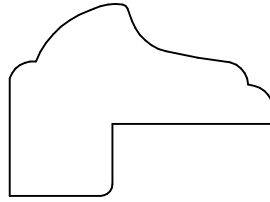

KL 507
1.000 x 1.375



KL 508
.500 x 1.437

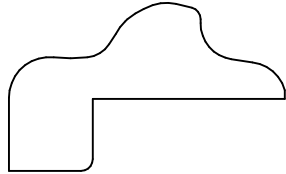

KL 509
.875 x 1.437



KL 510
.375 x 1.625

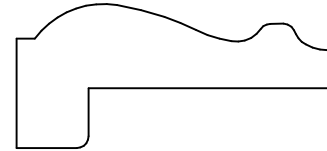

KL 511
.750 x 1.625

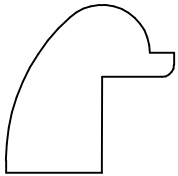

KL 512
.875 x .875

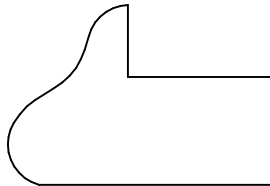

KL 513
1.375 x .937

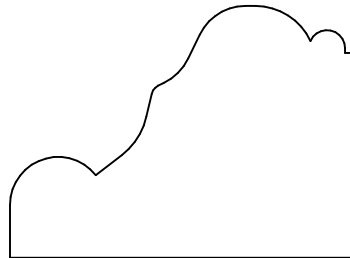

KL 516
1.312 x 1.812

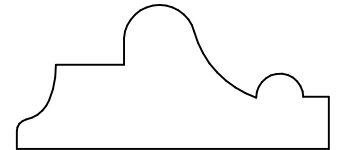

KL 519
.750 x 1.625

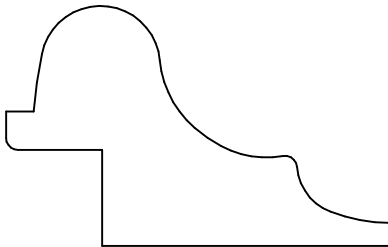

KL 517
1.250 x 2.000

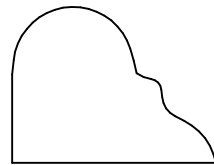

KL 521
.812 x 1.062

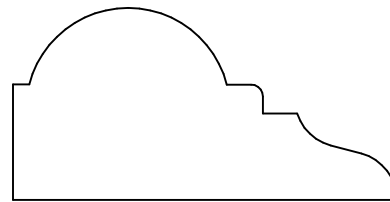

KL 522
1.000 x 2.000



KL 525
.625 x .750



KL 538
.250 x .687

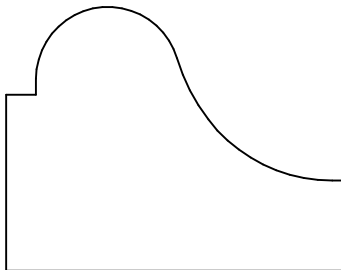

KL 524
1.375 x 1.750

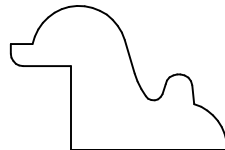

KL 526
.750 x 1.125

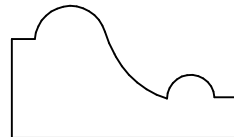

KL 528
.687 x 1.187

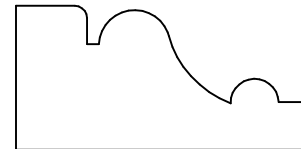

KL 529
.750 x 1.500

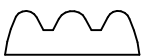

KL 540
.228 x .700

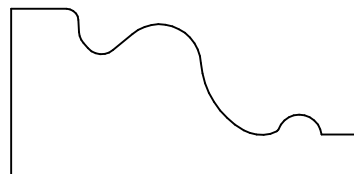

KL 530
.875 x 1.812

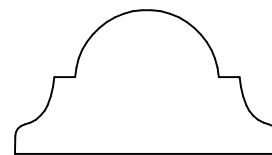

KL 531
.750 x 1.375

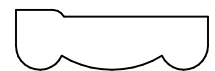

KL 539
.312 x 1.000

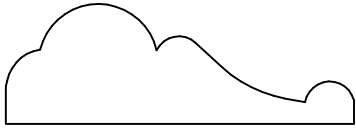

KL 532
.625 x 1.812

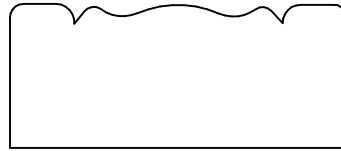

KL 533
.750 x 1.750

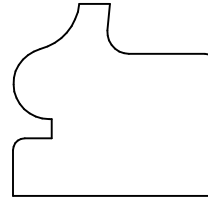

KL 541
1.000 x 1.062

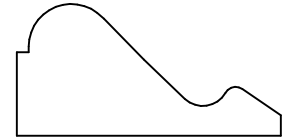

KL 542
.687 x 1.375

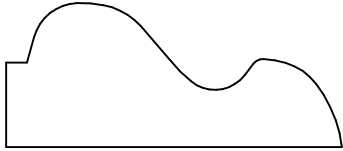

KL 543
.750 x 1.750

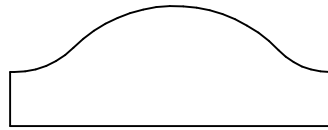

KL 544
.625 x 1.688

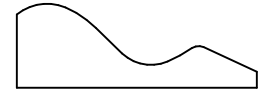

KL 545
.437 x 1.250

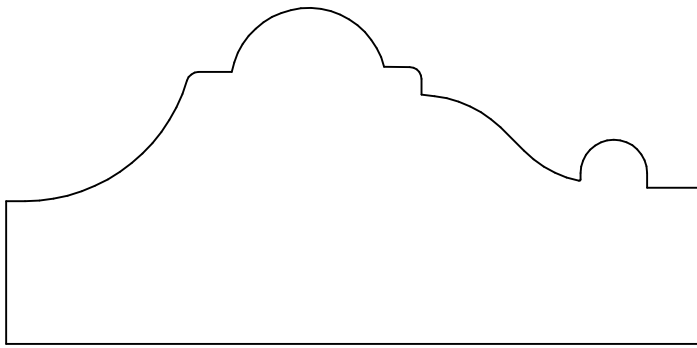

KL 546
1.750 x 3.625

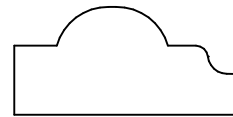

KL 547
.562 x 1.187

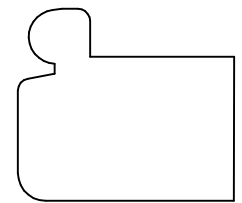

KL 550
1.000 x 1.125

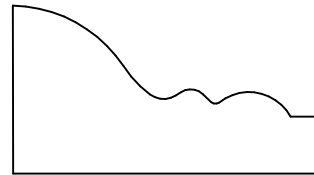

KL 548
.875 x 1.625

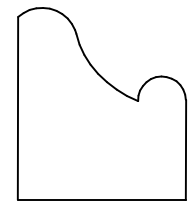

KL 554
1.000 x .875

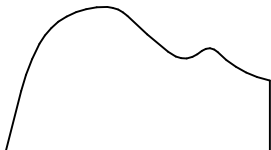

KL 549
.750 x 1.375

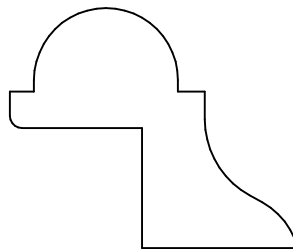

KL 552
1.250 x 1.500

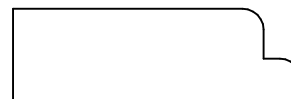

KL 553
.475 x 1.500



KL 557
.562 x 1.312

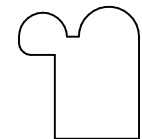

KL 568
.687 x .625

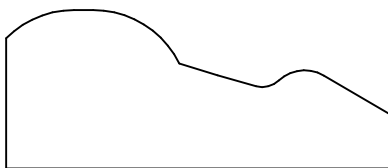

KL 555
.825 x 2.000

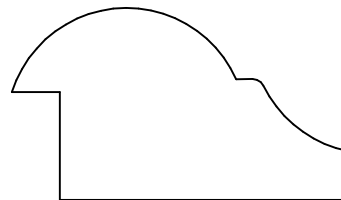

KL 556
1.000 x 1.750

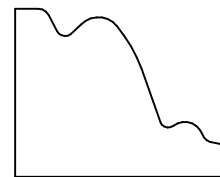

KL 558
.875 x 1.125

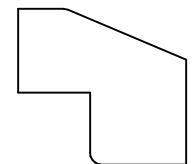

KL 569
.812 x .875

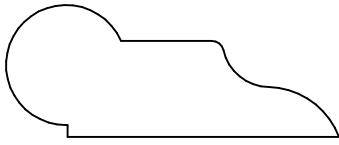

KL 559
.687 x 1.735

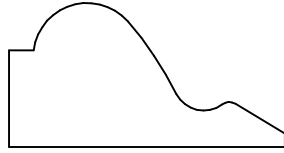

KL 560
.750 x 1.437

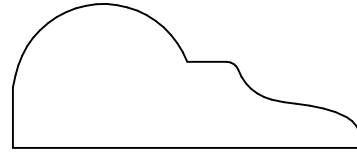

KL 561
.748 x 1.812

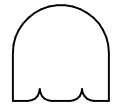

KL 583
.500 x .500

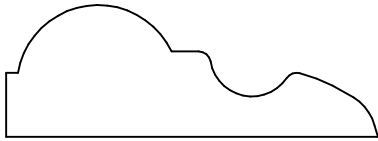

KL 562
.687 x 1.937

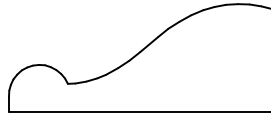

KL 563
.562 x 1.375

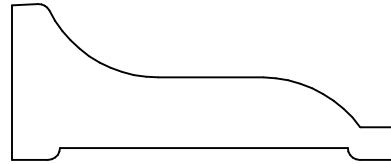

KL 564
.805 x 2.000



KL 1500
.312 x .625



KL 565
.375 x 1.312

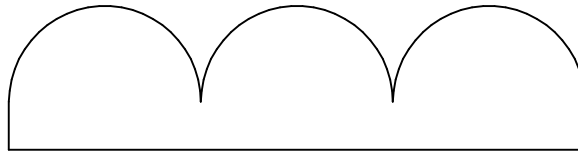

KL 566
.750 x 3.000

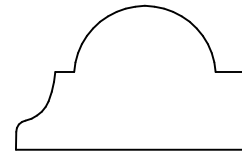

KL 567
.750 x 1.187

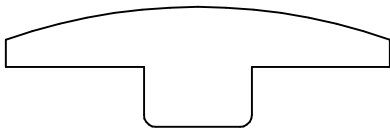

KL 570
.625 x 1.999

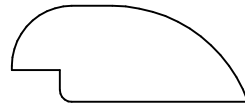

KL 571
.500 x 1.230

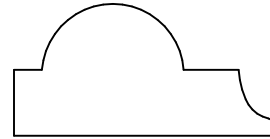

KL 572
.687 x 1.375

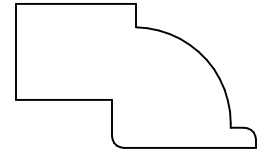

KL 574
.750 x 1.250

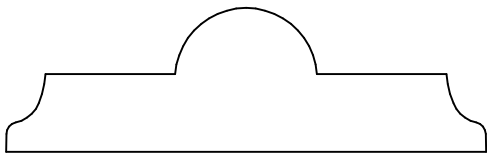

KL 573
.750 x 2.500

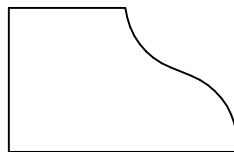

KL 575
.750 x 1.187

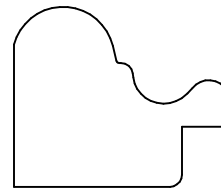

KL 576
.937 x 1.125

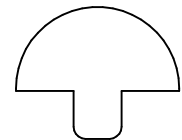

KL 579
.687 x .850

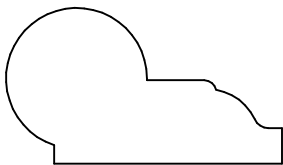

KL 577
.812 x 1.437



KL 578
.500 x 1.250

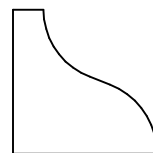

KL 580
.750 x .750

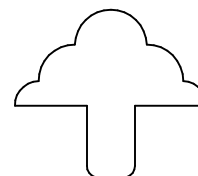

KL 581
.875 x 1.000



KL 582
.500 x .720



KL 592
.437 x .750

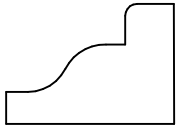

KL 584
.625 x .875



KL 585
.400 x 2.000

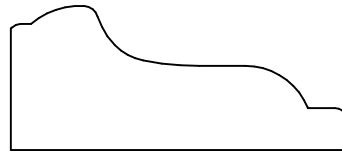

KL 586
.750 x 1.750

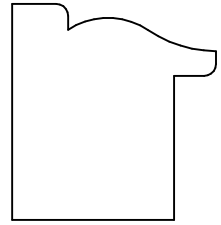

KL 587
1.125 x 1.062

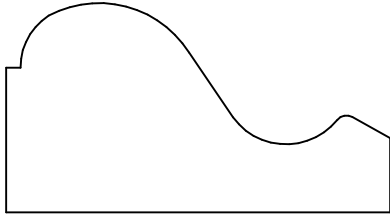

KL 588
1.090 x 2.000

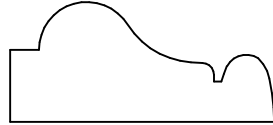

KL 589
.625 x 1.375

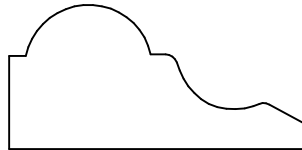

KL 590
.750 x 1.562

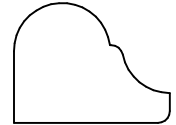

KL 593
.625 x .812

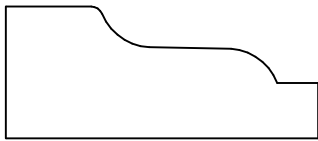

KL 591
.687 x 1.625

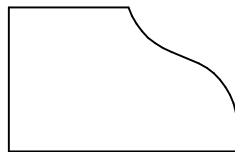

KL 594
.750 x 1.188

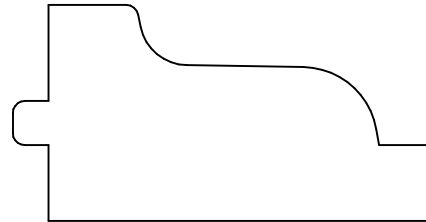

KL 595
1.125 x 2.000

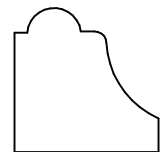

KL 598
.750 x .750

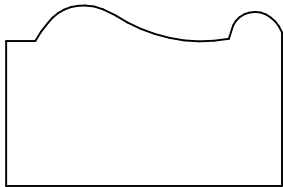

KL 596
.940 x 1.437

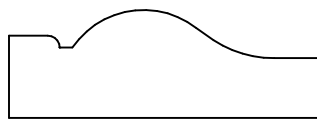

KL 597
.562 x 1.625

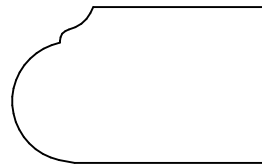

KL 1501
.812 x 1.343

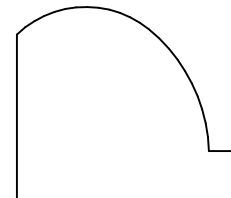

KL 1502
1.000 x 1.125

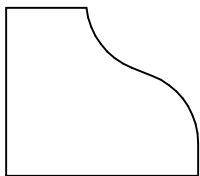

KL 1503
.875 x 1.000

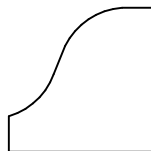

KL 1504
.750 x .750

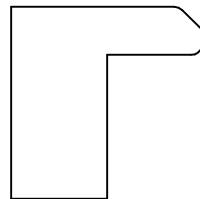

KL 1505
1.000 x 1.000

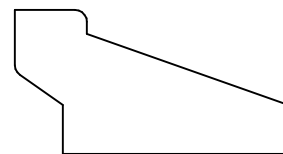

KL 1506
.750 x 1.437

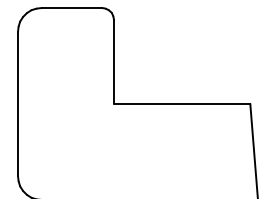

KL 1510
1.000 x 1.250

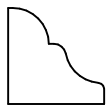

KL 1516
.500 x .500



KL 1520
.437 x 1.500

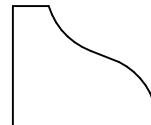

KL 1528
.625 x .750

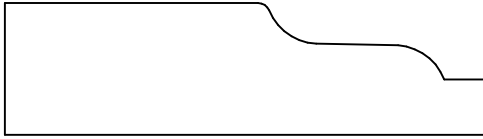

KL 1507
.687 x 2.500

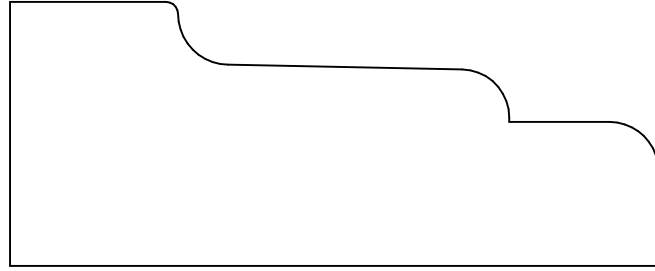

KL 1508
1.375 x 3.375

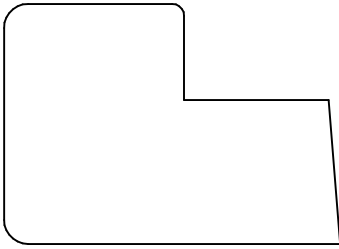

KL 1509
1.250 x 1.750

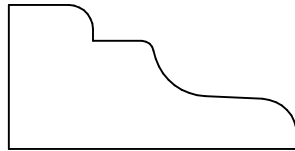

KL 1511
.750 x 1.500

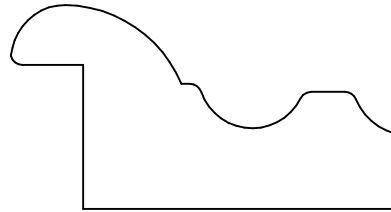

KL 1512
1.062 x 2.000

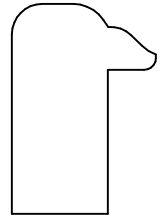

KL 1522
1.093 x .750

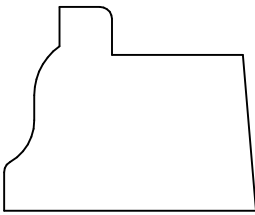

KL 1513
1.062 x 1.312

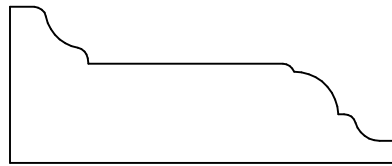

KL 1517
.812 x 2.000

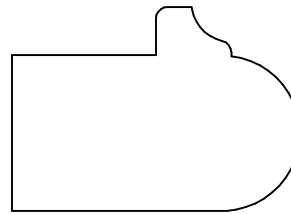

KL 1518
1.062 x 1.500

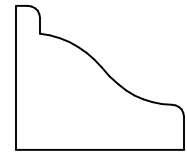

KL 1525
.750 x .875

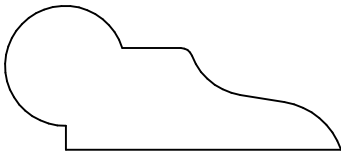

KL 1519
.750 x 1.750

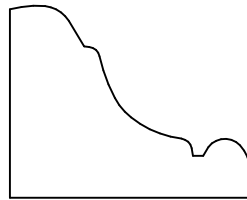

KL 1521
1.000 x 1.250

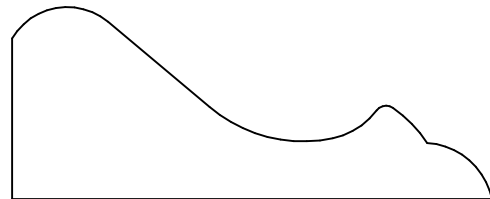

KL 1523
.995 x 2.500

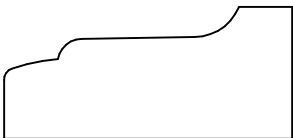

KL 1524
.687 x 1.500



KL 1526
.687 x 1.250

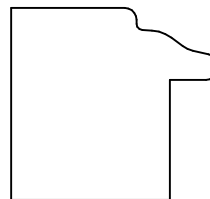

KL 1527
1.000 x 1.078

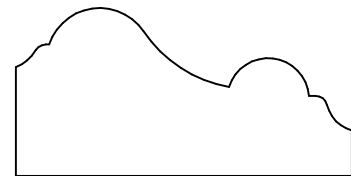

KL 1529
.875 x 1.750

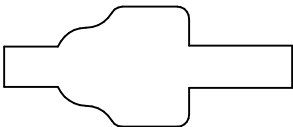

KL 1531
.625 x 1.500



KL 1548
.312 x .750

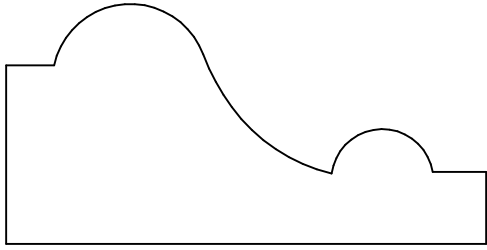

KL 1530
1.250 x 2.500

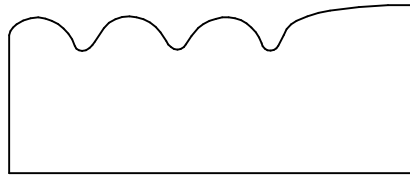

KL 1533
.875 x 2.125

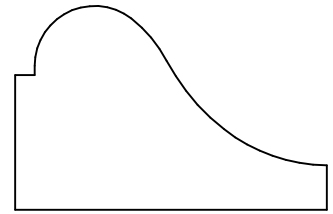

KL 1535
1.062 x 1.625

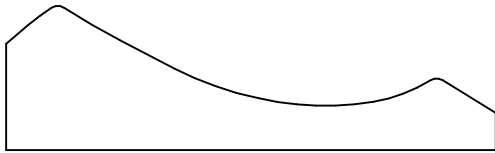

KL 1534
.750 x 2.550

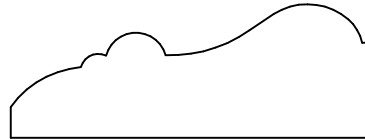

KL 1536
.696 x 1.877

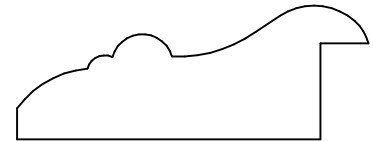

KL 1537
.695 x 1.829

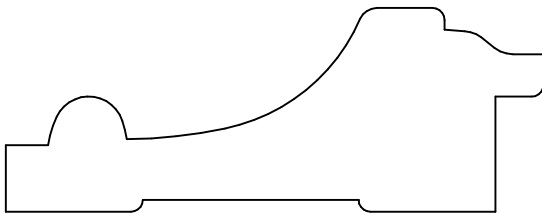

KL 1538
1.062 x 2.800

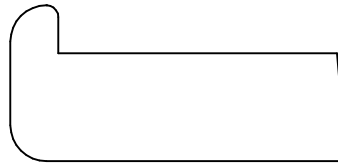

KL 1540
.812 x 1.750

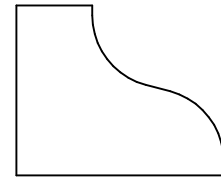

KL 1541
.885 x 1.080

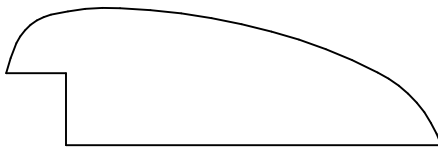

KL 1542
.715 x 2.267

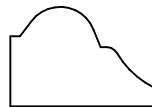

KL 1543
.518 x .750

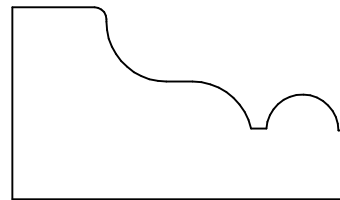

KL 1544
1.000 x 1.750

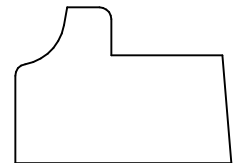

KL 1545
.812 x 1.125

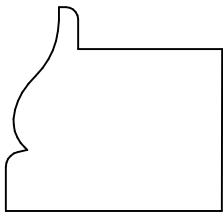

KL 1546
1.062 x 1.125

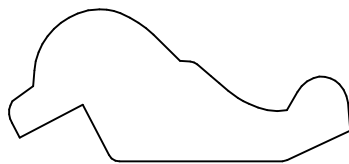

KL 1547
.792 x 1.778

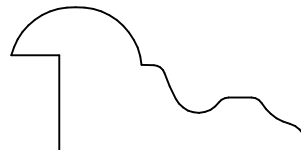

KL 1549
.750 x 1.541



KL 1550
.598 x 1.465



KL 1561
.312 x .437

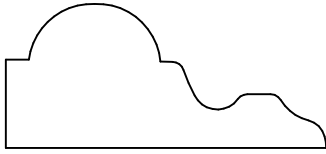

KL 1551
.750 x 1.668

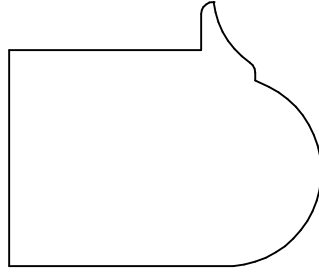

KL 1552
1.375 x 1.625

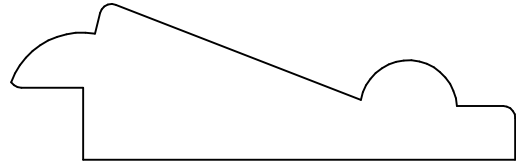

KL 1553
.812 x 2.625

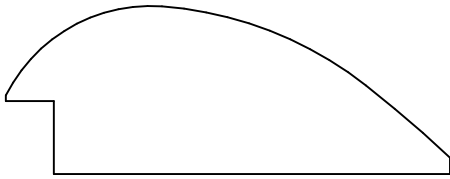

KL 1554
.875 x 2.312

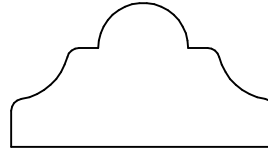

KL 1555
.750 x 1.375

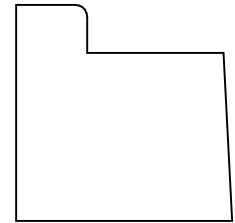

KL 1557
1.125 x 1.125

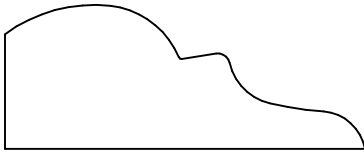

KL 1558
.750 x 1.875

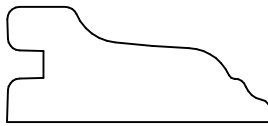

KL 1556
.600 x 1.375

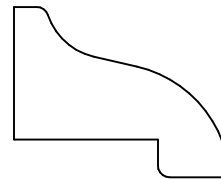

KL 1559
.888 x 1.125

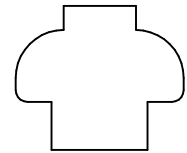

KL 1569
.750 x .875

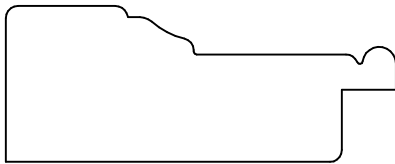

KL 1560
.812 x 2.031

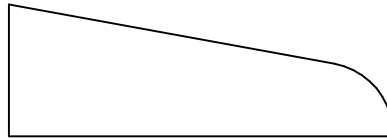

KL 1562
.687 x 2.000

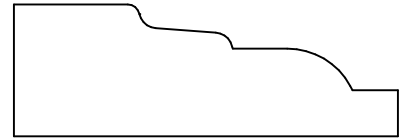

KL 1563
.687 x 2.000

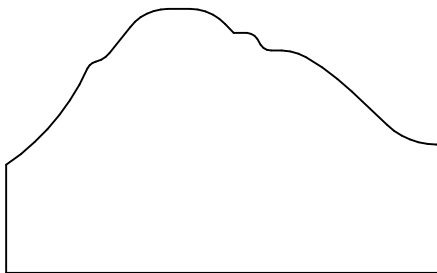

KL 1564
1.375 x 2.250

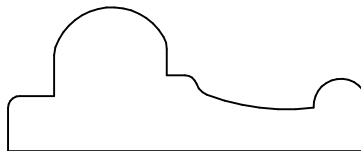

KL 1565
.750 x 1.875

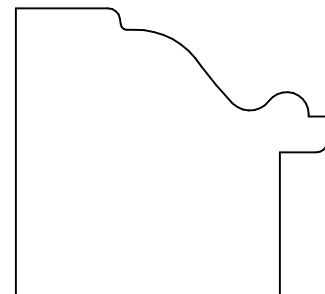

KL 1566
1.500 x 1.625

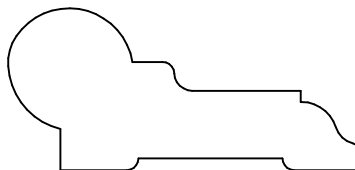

KL 1567
.843 x 1.843

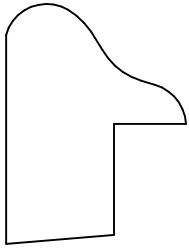

KL 1568
1.250 x .937



KL 1570
.750 x 1.312

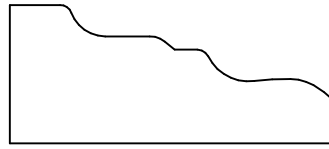

KL 1571
.720 x 1.687

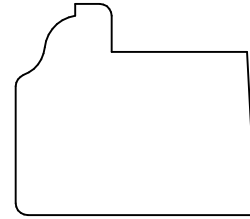

KL 1572
1.100 x 1.250

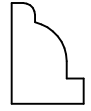

KL 1587
.525 x .375

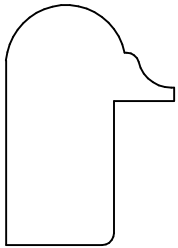

KL 1573
1.250 x .875

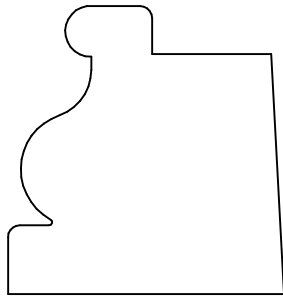

KL 1574
1.500 x 1.437

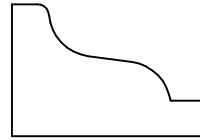

KL 1575
.687 x 1.000

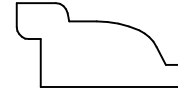

KL 1576
.437 x .875



KL 1577
.500 x .625

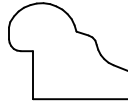

KL 1578
.500 x .625

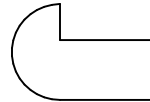

KL 1579
.500 x .750

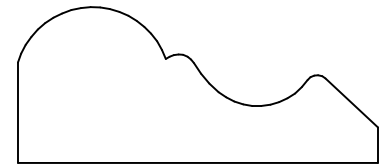

KL 1580
.812 x 1.875

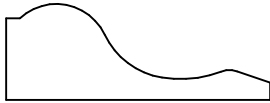

KL 1581
.500 x 1.375

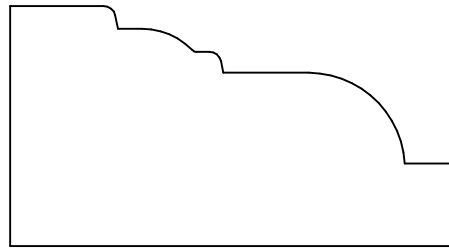

KL 1582
1.250 x 2.312

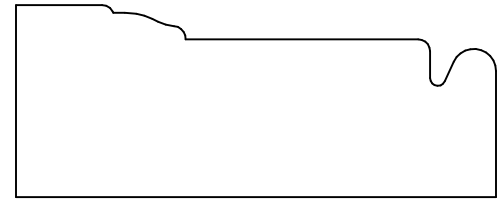

KL 1584
1.000 x 2.500

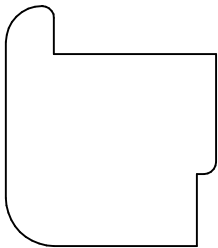

KL 1583
1.250 x 1.094

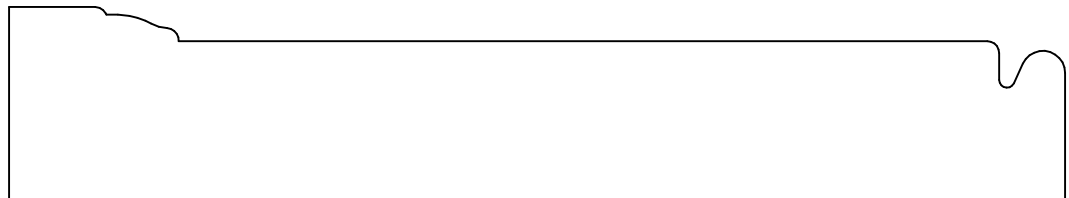

KL 1585
1.000 x 5.500

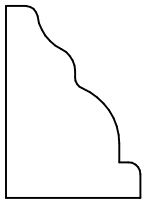

KL 1586
.700 x 1.000

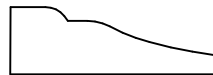

KL 1588
.350 x 1.062



KL 1591
.350 x .500



KL 1593
.749 x 1.250

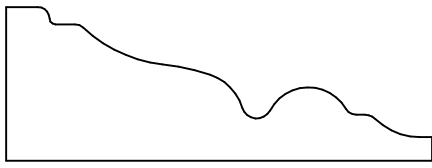

KL 1589
.800 x 2.218

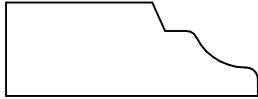

KL 1594
.487 x 1.312

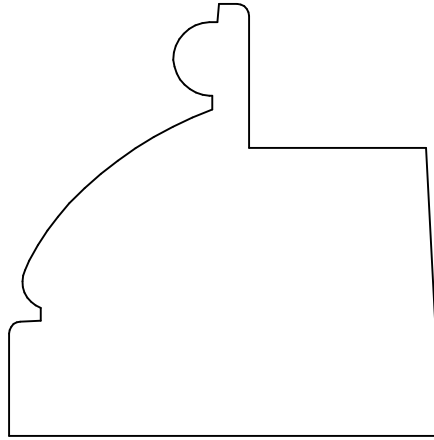

KL 1590
2.250 x 2.250

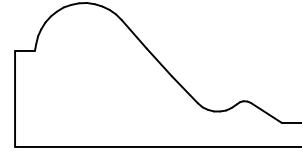

KL 1592
.750 x 1.500

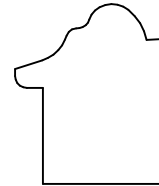

KL 1595
.937 x .775

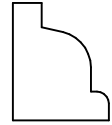

KL 3511
.612 x .500

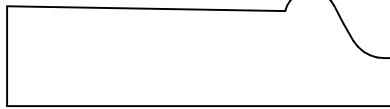

KL 1596
.600 x 2.000

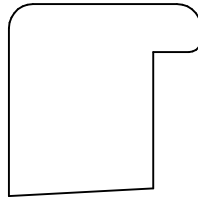

KL 1597
1.000 x 1.000

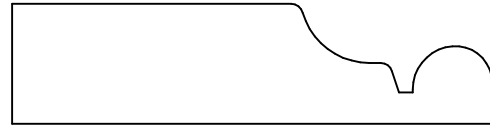

KL 1599
.625 x 2.500

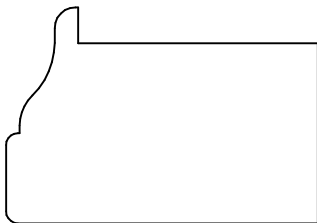

KL 1598
1.125 x 1.625

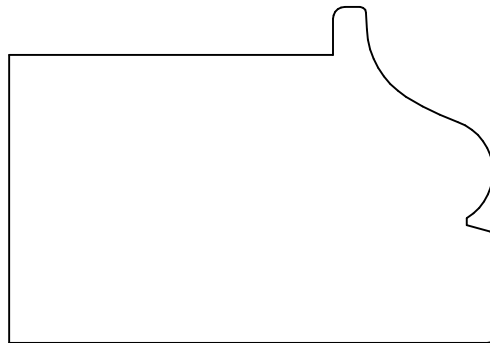

KL 3500
1.750 x 2.552

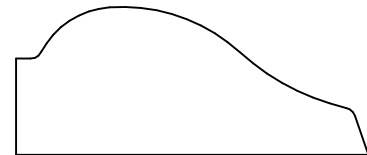

KL 3501
.770 x 1.835

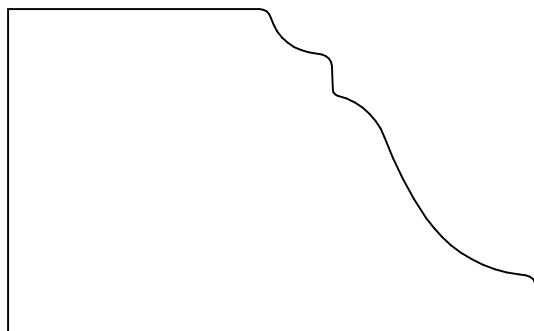

KL 3502
1.687 x 2.750

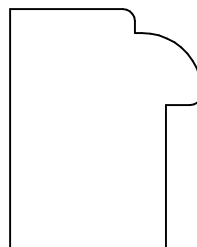

KL 3504
1.250 x 1.000

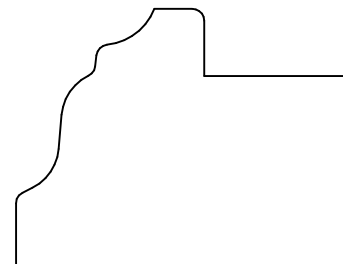

KL 3503
1.350 x 1.730

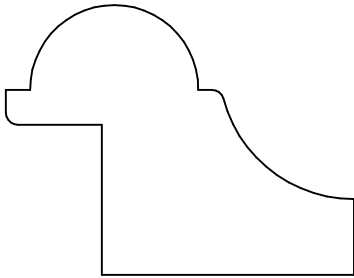

KL 3505
1.406 x 1.812

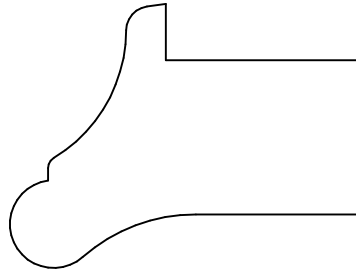

KL3506
1.812 x 1.375

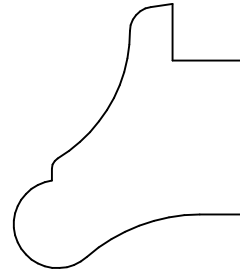

KL 3507
1.375 x 1.218

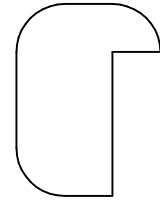

KL 3513
1.000 x .750

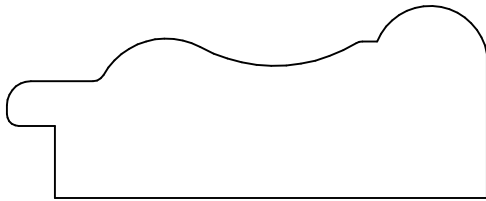

KL3508
1.000 x 2.500

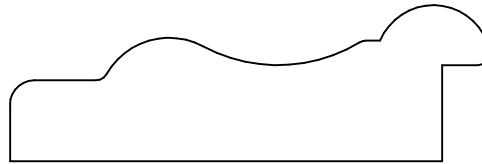

KL 3509
.812 x 2.500

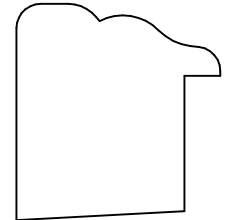

KL 3520
1.125 x 1.062



KL 3512
.422 x 2.000

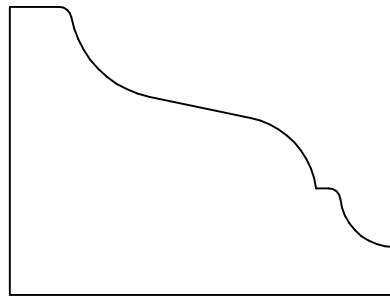

KL 3514
1.500 x 2.000

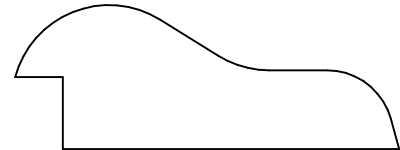

KL 3515
.750 x 2.000

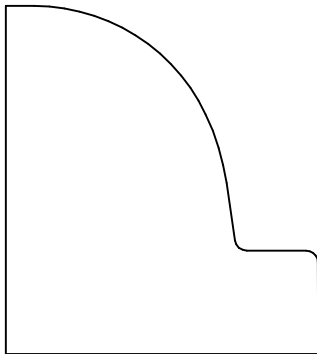

KL 3516
1.812 x 1.625

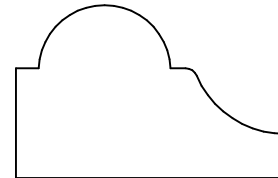

KL 3518
.900 x 1.406

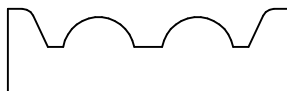

KL 3521
.437 x 1.460

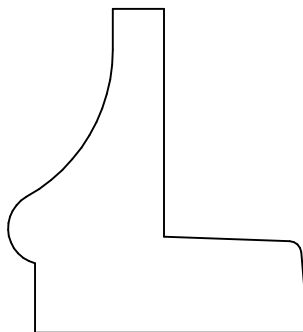

KL 3517
1.687 x 1.562

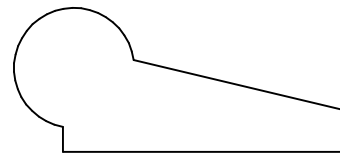

KL 3519
.750 x 1.750



KL 3524
.687 x .875

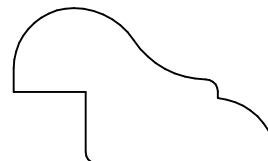

KL 3522
.813 x 1.375

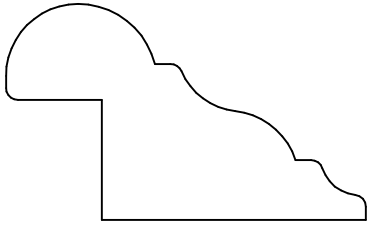

KL 3523
1.125 x 1.875

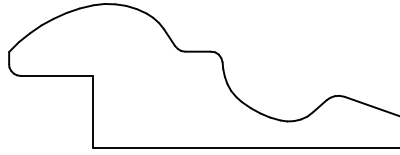

KL 3525
.750 x 2.050

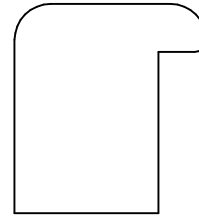

KL 3526
1.089 x 1.000

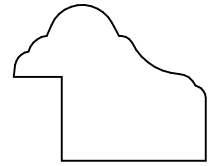

KL 3534
.812 x 1.000

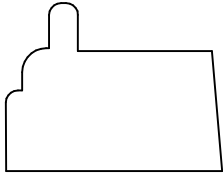

KL 3527
.875 x 1.125

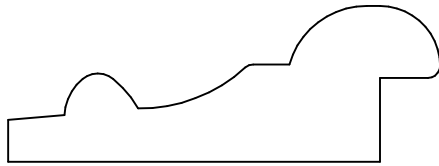

KL 3528
.812 x 2.250



KL 3529
.625 x 1.125

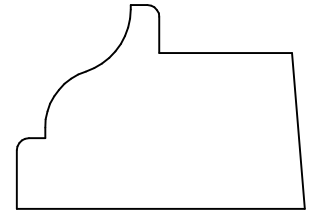

KL 3530
1.062 x 1.500

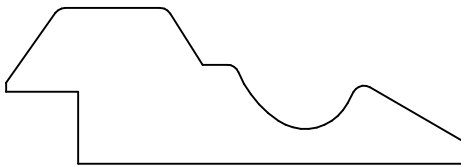

KL 3531
.812 x 2.375

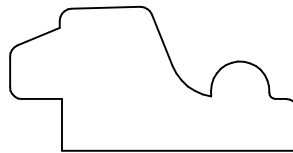

KL 3532
.750 x 1.500

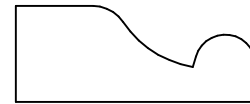

KL 3533
.500 x 1.250



KL 3541
.500 x .750

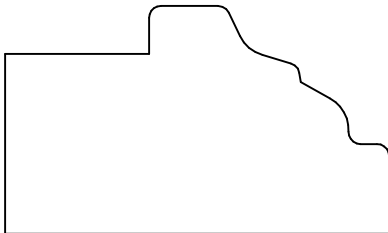

KL 3535
1.187 x 2.000

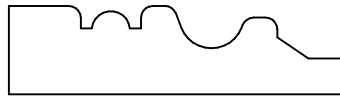

KL 3536
.460 x 1.750

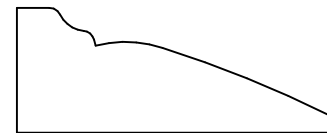

KL 3537
.650 x 1.625

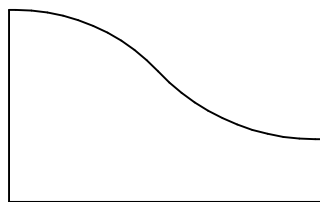

KL 3538
1.000 x 1.625

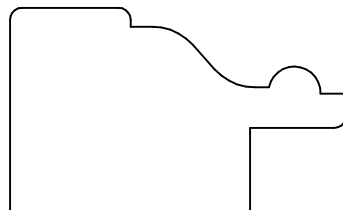

KL 3539
1.062 x 1.750

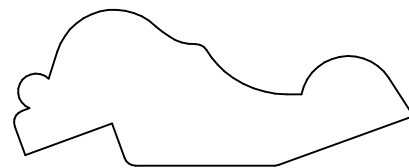

KL 3540
.812 x 2.058

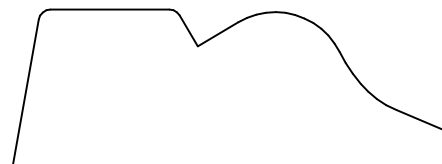

KL 3542
.812 x 2.250



KL 3555
.340 x .750

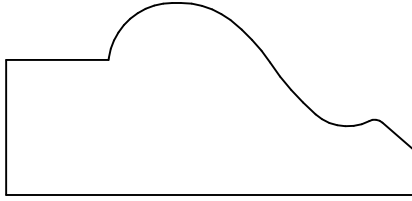

KL 3543
1.000 x 2.125

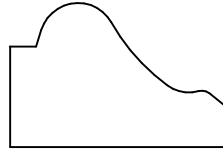

KL 3544
.750 x 1.125



KL 3545
.625 x 1.375

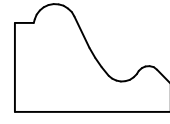

KL 3546
.562 x .812

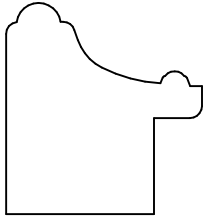

KL 3547
1.100 x 1.020

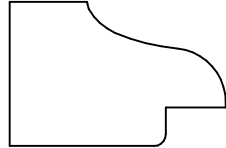

KL 3548
.750 x 1.125



KL 3561
.460 x .665

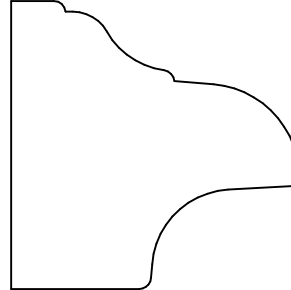

KL 3549
1.500 x 1.500

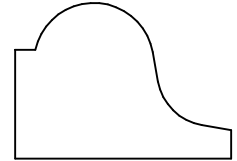

KL 3551
.812 x 1.125



KL 3552
.500 x .812



KL 3562
.750 x .625

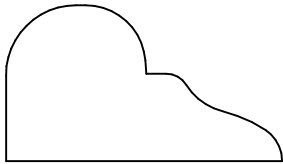

KL 3550
.812 x 1.437

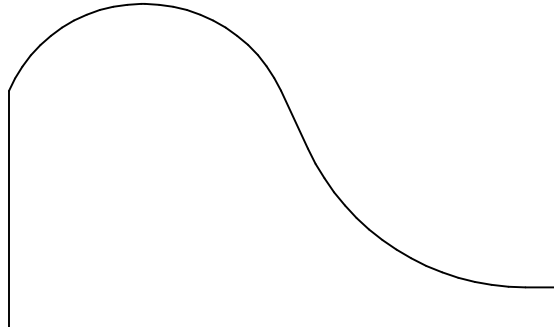

KL 3553
1.687 x 2.875

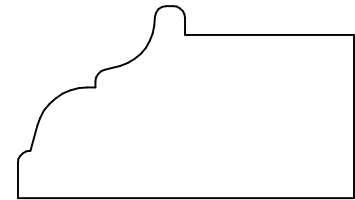

KL 3556
1.000 x 1.750

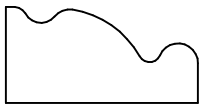

KL 3567
.500 x 1.000

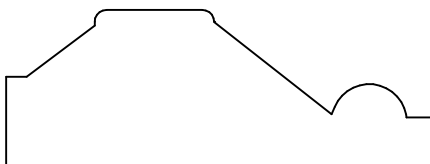

KL 3554
.812 x 2.220

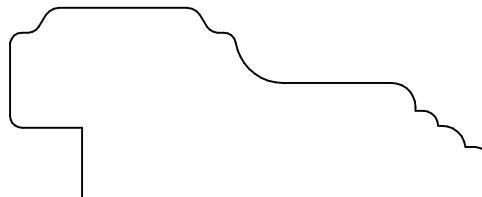

KL 3557
1.000 x 2.500

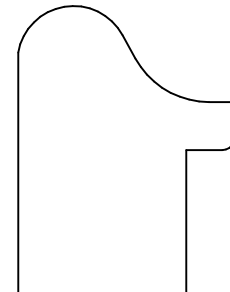

KL 3560
1.500 x 1.125

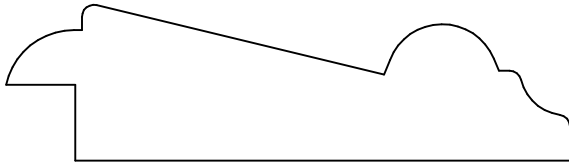

KL 3558
.812 x 2.937

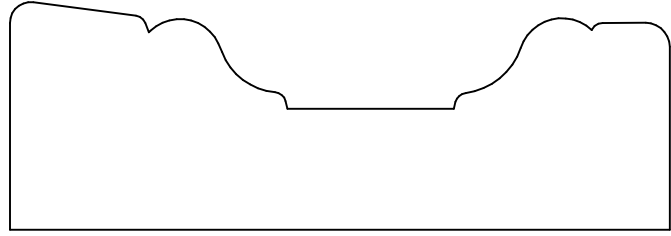

KL 3559
1.187 x 3.437

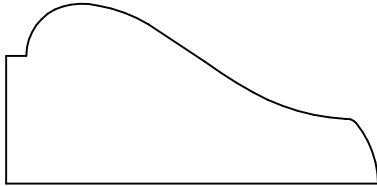

KL 3563
.937 x 1.937

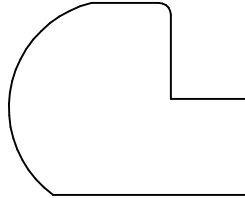

KL 3564
1.000 x 1.020

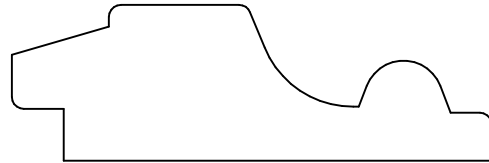

KL 3565
.812 x 2.500

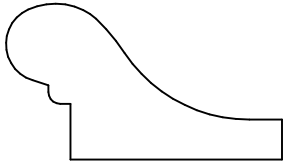

KL 3566
.812 x 1.437

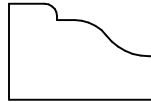

KL 3568
.500 x .750

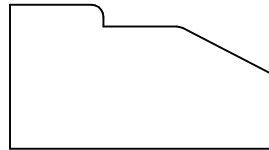

KL 3569
.750 x 1.375

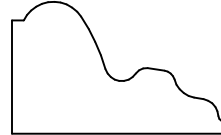

KL 3570
.687 x 1.125



KL 3574
.562 x .843

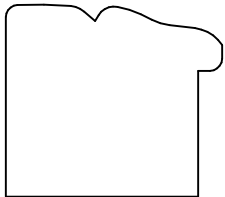

KL 3571
1.000 x 1.125

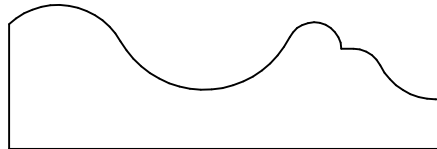

KL 3572
.750 x 2.250

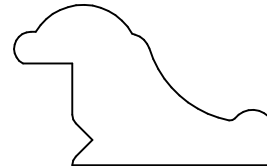

KL 3573
.835 x 1.375



KL 3575
.562 x .718



KL 3576
.600 x 1.161

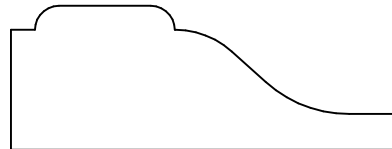

KL 3577
.750 x 2.000

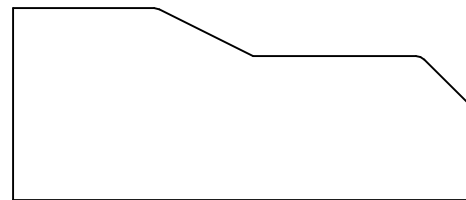

KL 3578
1.000 x 2.375

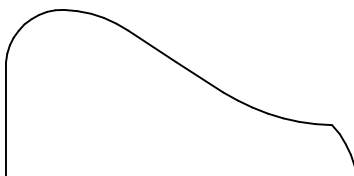

KL 3579
.875 x 1.828

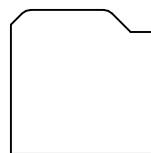

KL 3582
.750 x .750



KL 3585
.598 x 1.990

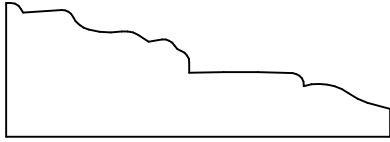

KL 3580
.696 x 2.000

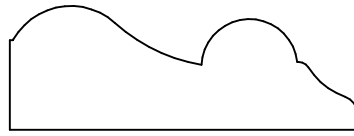

KL 3581
.645 x 1.812

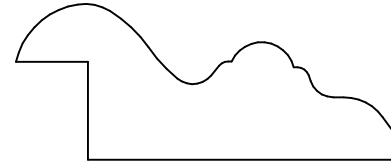

KL 3583
.812 x 1.960

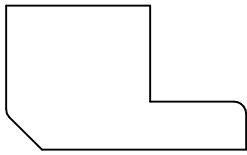

KL 3584
.750 x 1.250

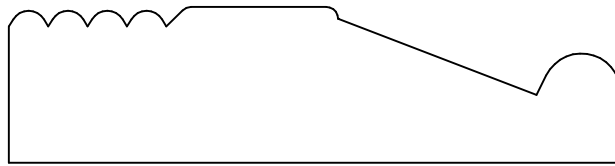

KL 3586
.812 x 3.187

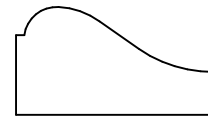

KL 3588
.562 x 1.031

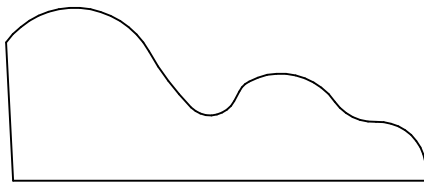

KL 3587
.900 x 2.187

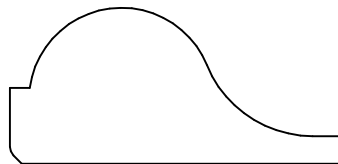

KL 3589
.812 x 1.750

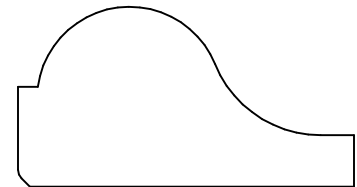

KL 3590
.937 x 1.750

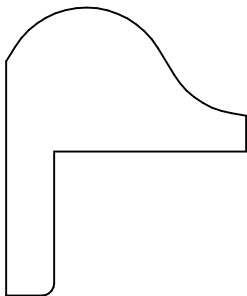

KL 3591
1.500 x 1.250

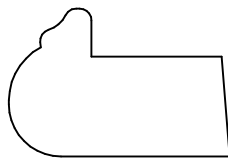

KL 3592
.770 x 1.150

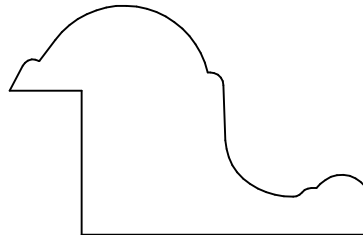

KL 3593
1.192 x 1.882

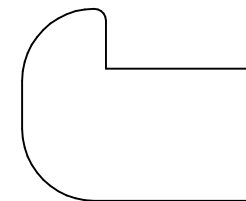

KL 3596
1.000 x 1.187

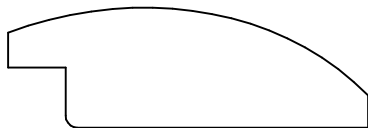

KL 3594
.625 x 1.875

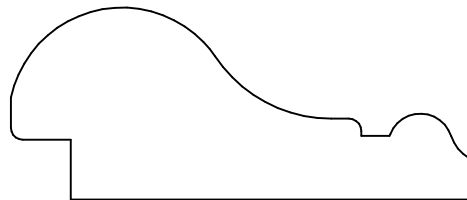

KL 3595
1.000 x 2.420

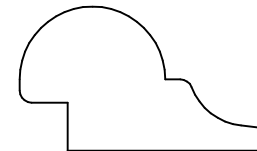

KL 3597
.750 x 1.250

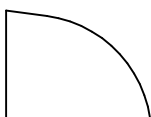

KL 3598
.562 x .750

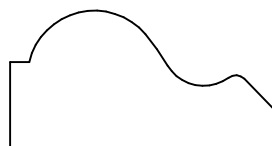

KL 3599
.725 x 1.375



KL 4501
.516 x 1.150

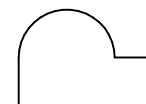

KL 4512
.500 x .682

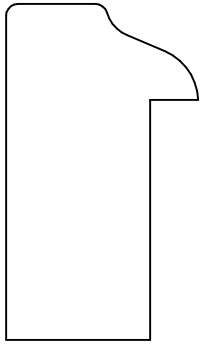

KL 4500
1.750 x 1.000

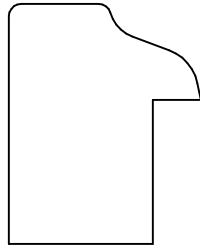

KL 4502
1.250 x 1.000



KL 4503
.500 x 1.250

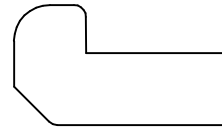

KL 4504
.625 x 1.125



KL 4508
.593 x 1.125

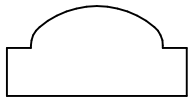

KL 4515
.468 x .937

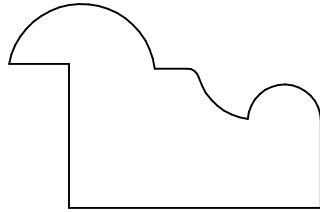

KL 4505
1.062 x 1.625

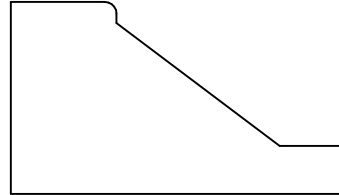

KL 4506
1.000 x 1.750

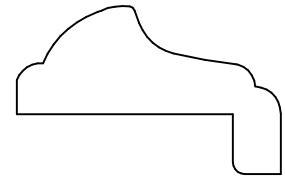

KL 4507
.875 x 1.375

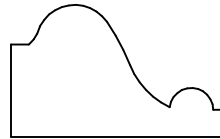

KL 4510
.687 x 1.125



KL 4511
.423 x 1.089

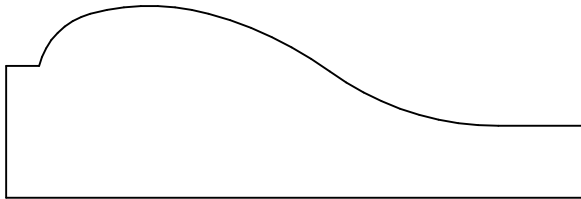

KL 4509
1.000 x 3.000

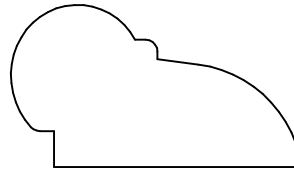

KL 4513
.844 x 1.514

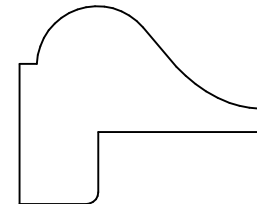

KL 4517
1.031 x 1.250

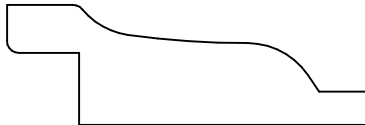

KL 4514
.625 x 1.875



KL 4516
.455 x 3.188



KL 4538
.281 x .437

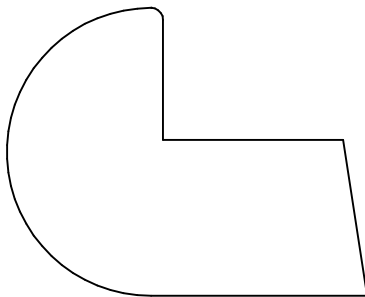

KL 4518
1.875 x 1.500



KL 4519
.750 x 1.500

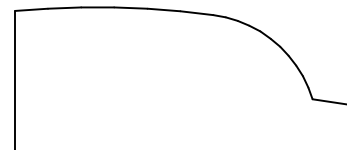

KL 4520
.750 x 1.750

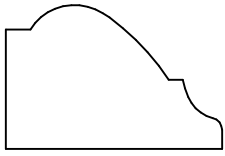

KL 4521
.750 x 1.125

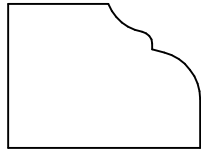

KL 4522
.750 x 1.000

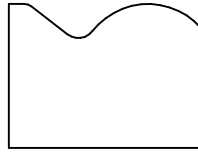

KL 4523
.750 x 1.000

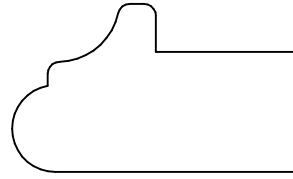

KL 4524
.875 x 1.500



KL 4526
.468 x .375



KL 4525
.687 x 1.125

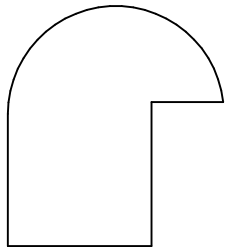

KL 4527
1.250 x 1.122

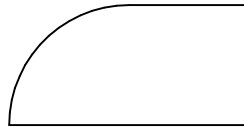

KL 4528
.625 x 1.250

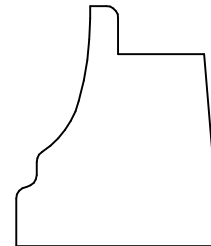

KL 4529
1.250 x 1.062

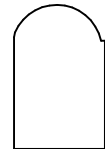

KL 4532
.474 x .750

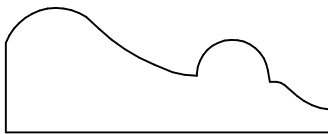

KL 4530
.648 x 1.684

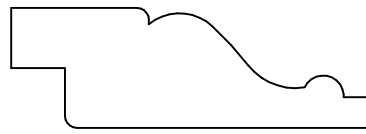

KL 4531
.625 x 1.875

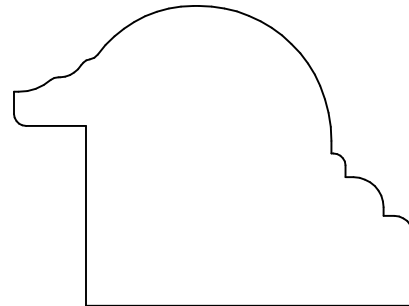

KL 4533
1.562 x 2.075

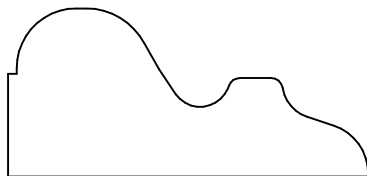

KL 4534
.875 x 1.875

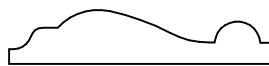

KL 4548
.275 x 1.375

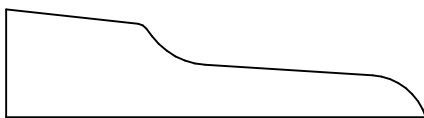

KL 4535
.562 x 2.187

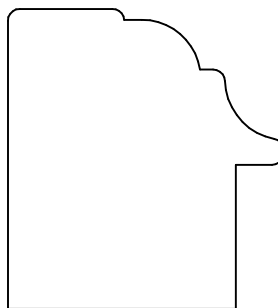

KL 4536
1.562 x 1.437

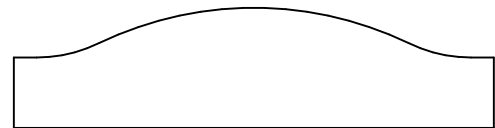

KL 4537
.625 x 2.500

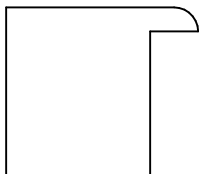

KL 4539
.875 x 1.000



KL 4544
.594 x .655

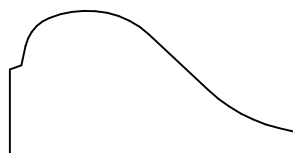

KL 4545
.750 x 1.500

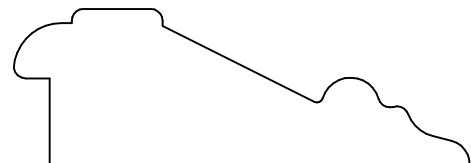

KL 4543
.812 x 2.375

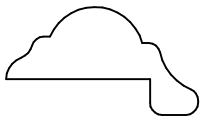

KL 4546
.562 x 1.000

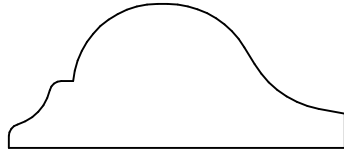

KL 4547
.750 x 1.750

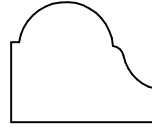

KL 4549
.625 x .750

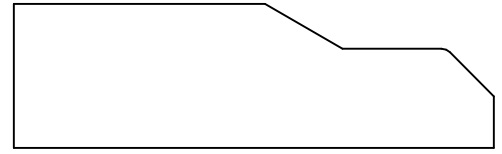

KL 4550
.750 x 2.500

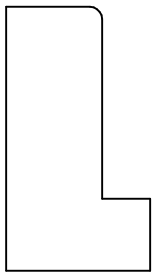

KL 4551
1.375 x .750

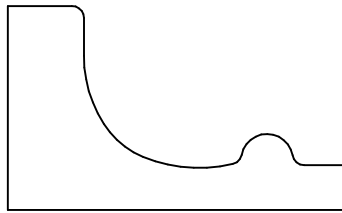

KL 4552
1.062 x 1.750

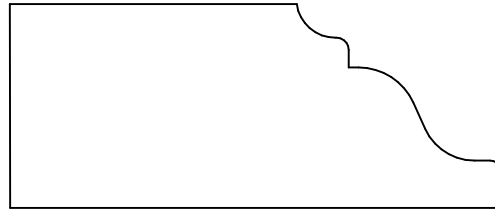

KL 4553
1.062 x 2.562

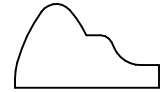

KL 4554
.437 x .750

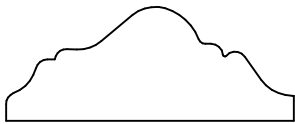

KL 4555
.594 x 1.500

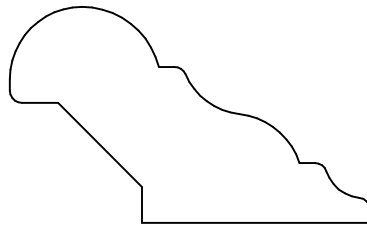

KL 4556
1.125 x 1.875

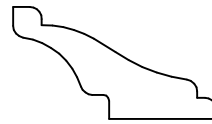

KL 4557
.582 x 1.063

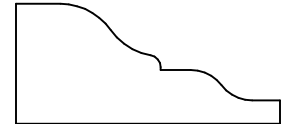

KL 4558
.625 x 1.375

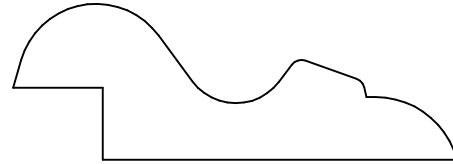

KL 4561
.812 x 2.312

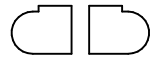

KL 4586
.250 x .717

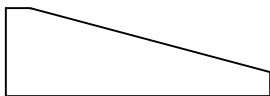

KL 4559
.458 x 1.375

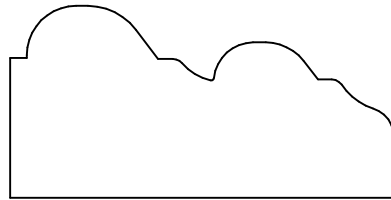

KL 4560
1.000 x 2.000



KL 4563
.600 x .875

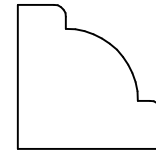

KL 4565
.750 x .750



KL 4582
.406 x .375

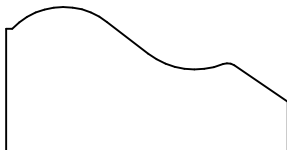

KL 4562
.750 x 1.468

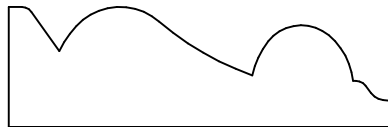

KL 4564
.625 x 2.000

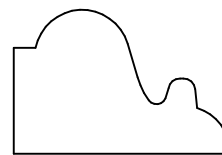

KL 4567
.750 x 1.125

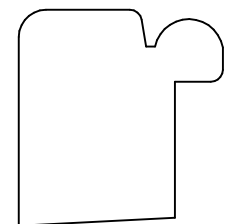

KL 4572
1.125 x 1.062

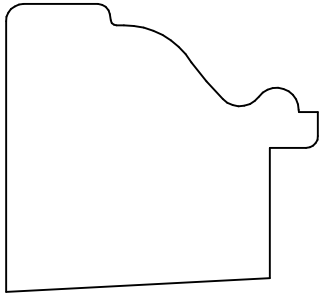

KL 4573
1.500 x 1.625

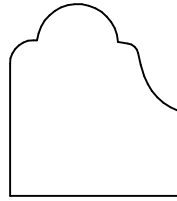

KL 4576
1.000 x .875

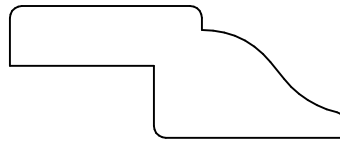

KL 4577
.687 x 1.750

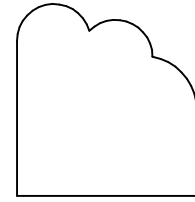

KL 4578
.998 x .937

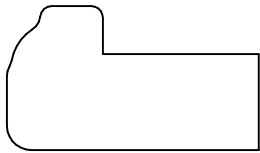

KL 4580
.750 x 1.312

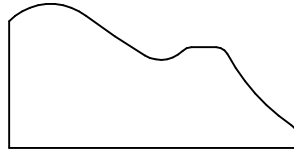

KL 4579
.749 x 1.500

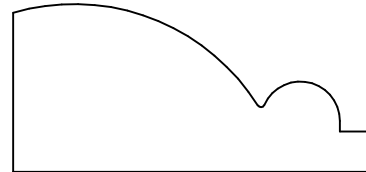

KL 4581
.875 x 1.875

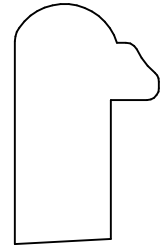

KL 4583
1.250 x .750

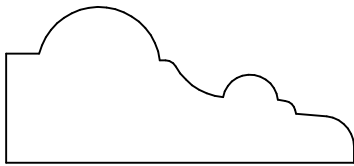

KL 4584
.812 x 1.812

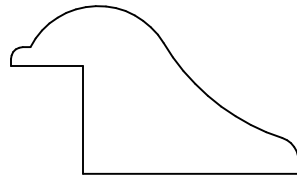

KL 4585
.875 x 1.500



KL 4587
.468 x .700



KL 4588
.650 x .625



KL 4597
.343 x .468

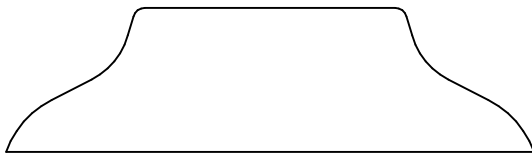

KL 4589
.750 x 2.750

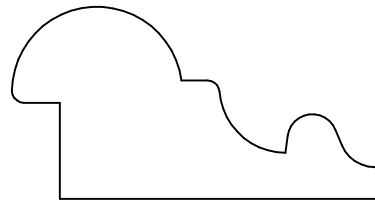

KL 4590
1.000 x 1.937



KL 4591
.625 x 1.625

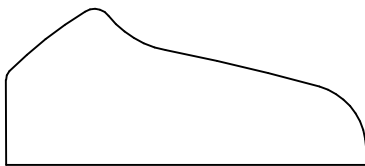

KL 4592
.812 x 1.875

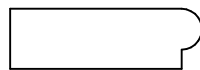

KL 4593
.312 x 1.000

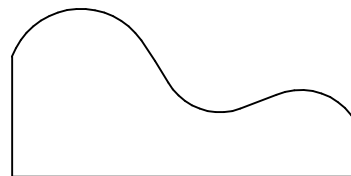

KL 4594
.875 x 1.812

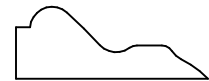

KL 4595
.375 x 1.000

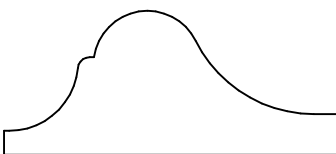

KL 4596
.750 x 1.750



KL 5505
.625 x .438



KL 5517
.437 x .812



KL 5506
.538 x .370

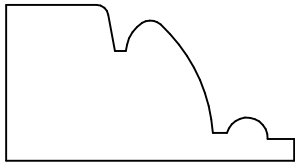

KL 4598
.812 x 1.500

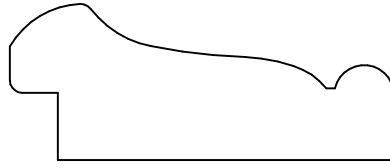

KL 4599
.812 x 2.000

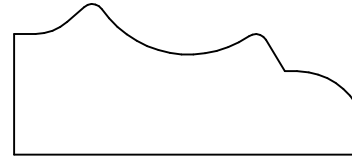

KL 5500
.785 x 1.780

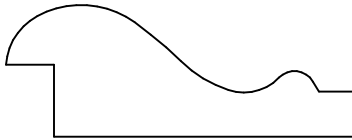

KL 5501
.687 x 1.812

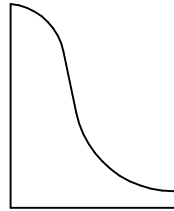

KL 5502
1.062 x .875

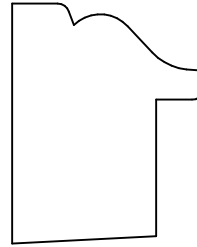

KL 5503
1.250 x 1.000

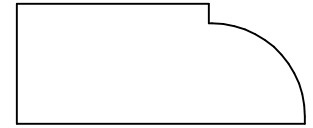

KL 5507
.625 x 1.500

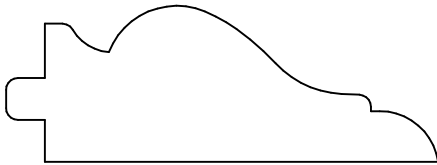

KL 5504
.812 x 2.250

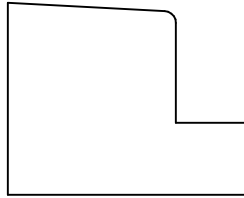

KL 5508
1.000 x 1.250

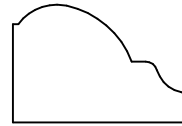

KL 5521
.613 x .925

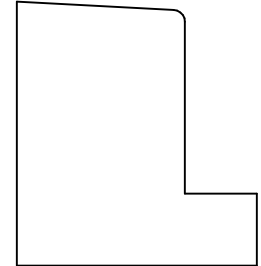

KL 5509
1.375 x 1.250

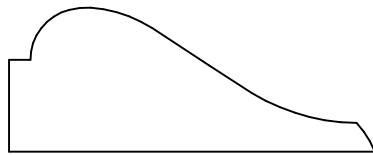

KL 5510
.750 x 1.906

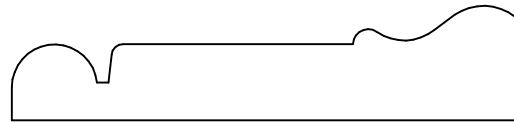

KL 5511
.596 x 2.650

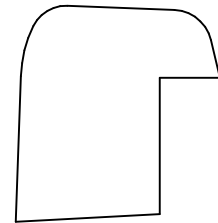

KL 5512
1.125 x 1.063

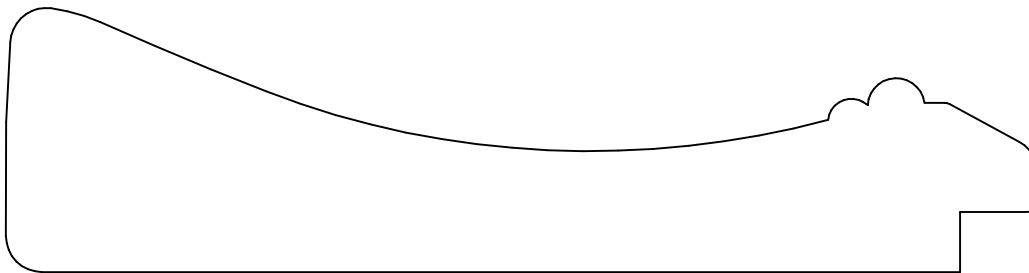

KL 5513
1.374 x 5.375

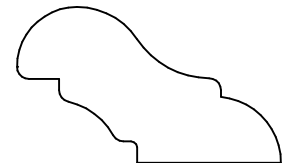

KL 5516
.812 x 1.375



KL 5522
.538 x .811

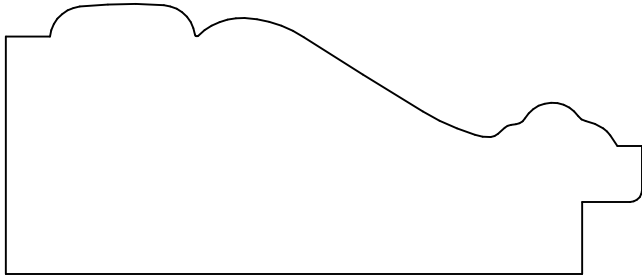

KL 5514
1.406 x 3.312

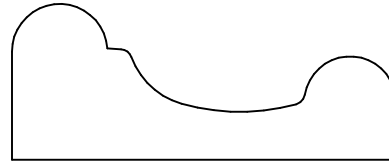

KL 5518
.812 x 2.000

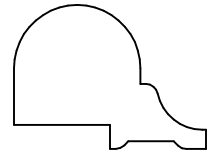

KL 5527
.750 x 1.000

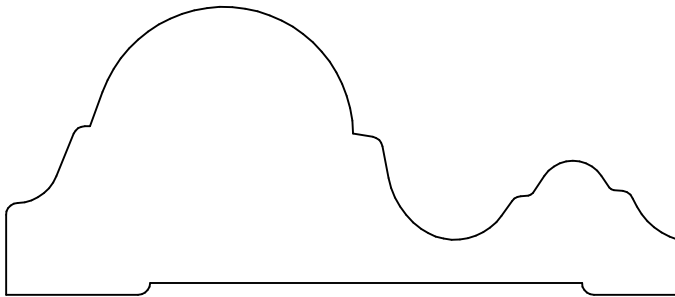

KL 5515
1.500 x 3.500

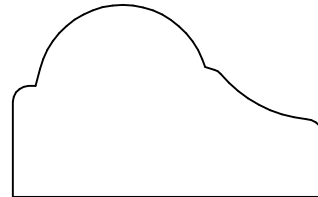

KL 5519
1.000 x 1.625

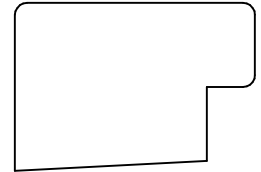

KL 5523
.875 x 1.250

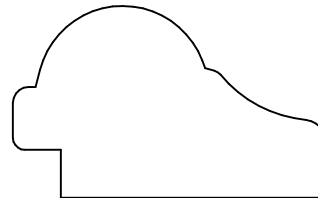

KL 5520
1.000 x 1.625



KL 5529
.375 x 1.000

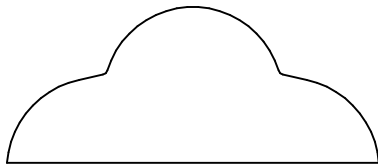

KL 5524
.812 x 1.937

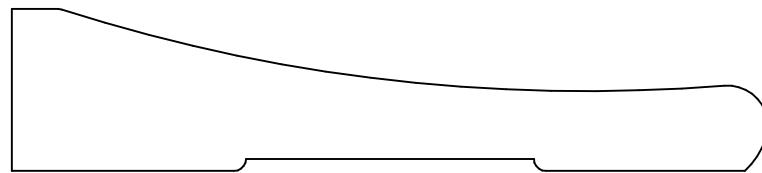

KL 5526
.844 x 3.937



KL 5560
.250 x .350

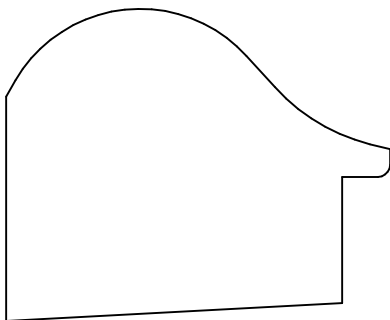

KL 5525
1.625 x 2.000

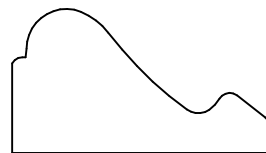

KL 5528
.750 x 1.343

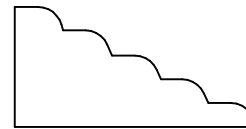

KL 5530
.625 x 1.250

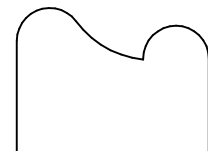

KL 5532
.750 x 1.000

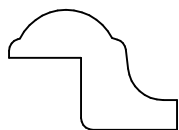

KL 5536
.625 x .875



KL 5542
.562 x .687

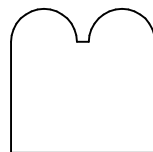

KL 5533
.750 x .750

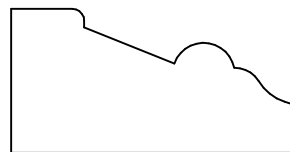

KL 5534
.750 x 1.500



KL 5531
1.000 x 4.500

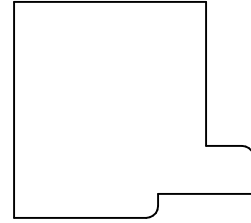

KL 5537
1.125 x 1.250

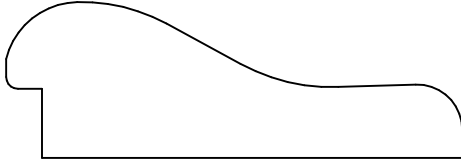

KL 5535
.812 x 2.375

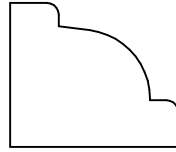

KL 5538
.750 x .875

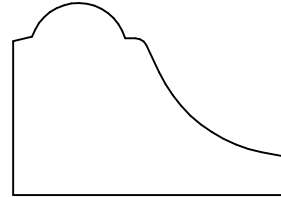

KL 5539
1.000 x 1.437

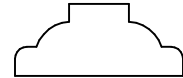

KL 5545
.375 x .875

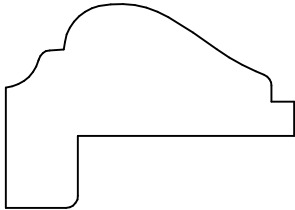

KL 5540
1.062 x 1.500

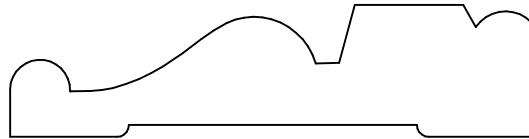

KL 5541
.687 x 2.739

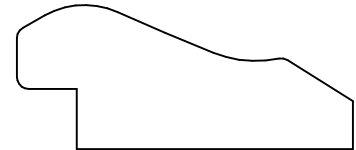

KL 5543
.750 x 1.750

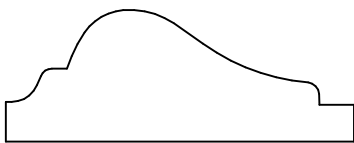

KL 5544
.687 x 1.812



KL 5546
.750 x 1.500



KL 5547
.562 x 1.125

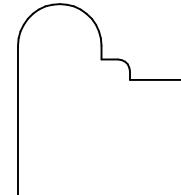

KL 5548
1.000 x .878

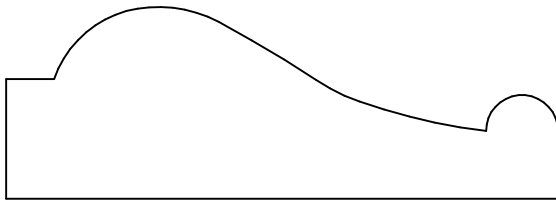

KL 5549
1.000 x 2.875

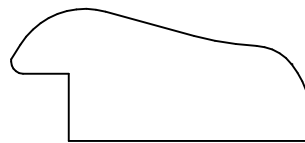

KL 5550
.687 x 1.562

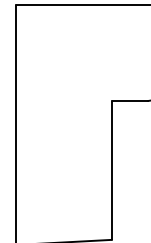

KL 5551
1.250 x .750



KL 5557
.375 x .750

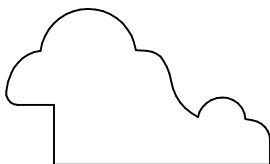

KL 5553
.812 x 1.375

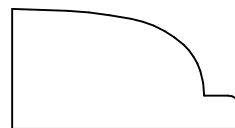

KL 5559
.625 x 1.187

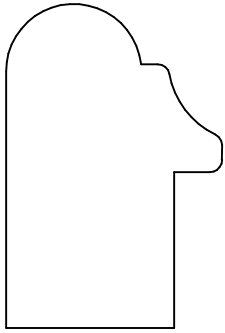

KL 5552
.1687 x 1.125



KL 5554
.625 x 2.000

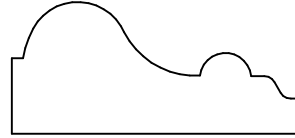

KL 5555
.687 x 1.500

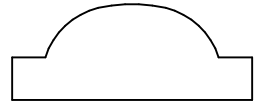

KL 5561
.500 x 1.250

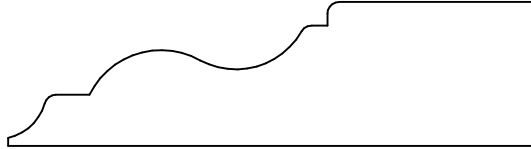

KL 5556
.750 x 2.750

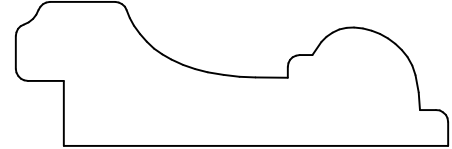

KL 5558
.750 x 2.250



KL 5562
.812 x 3.000

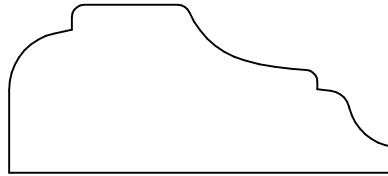

KL 5563
.875 x 2.000

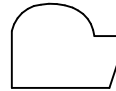

KL 5567
.437 x .562



KL 5580
.375 x .437

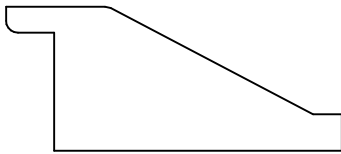

KL 5564
.750 x 1.750

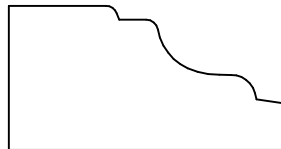

KL 5565
.750 x 1.437

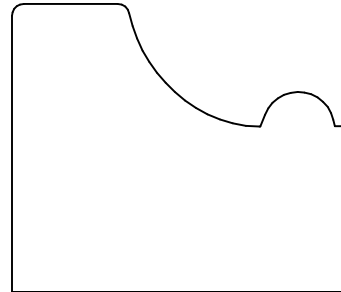

KL 5566
1.500 x 1.750



KL 5568
.375 x 1.000

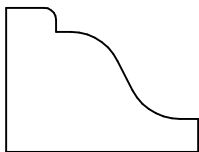

KL 5570
.750 x 1.000

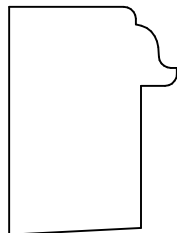

KL 5571
1.187 x .875

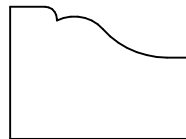

KL 5572
.687 x .937



KL 5569
.500 x .750

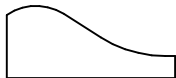

KL 5576
.375 x .875



KL 5588
.250 x .750

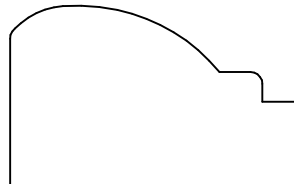

KL 5573
.937 x 1.500

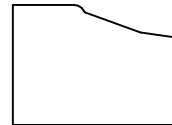

KL 5574
.625 x .875

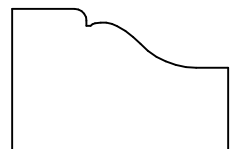

KL 5575
.750 x 1.125



KL 5578
.467 x .902

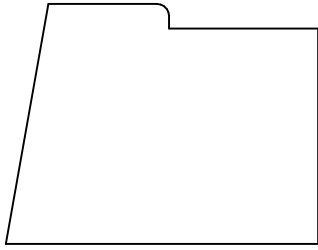

KL 5577
1.250 x 1.625

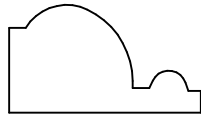

KL 5579
.562 x 1.000

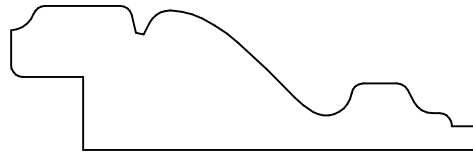

KL 5581
.750 x 2.437



KL 5587
.500 x .875

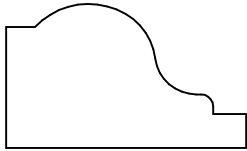

KL 5582
.750 x 1.250

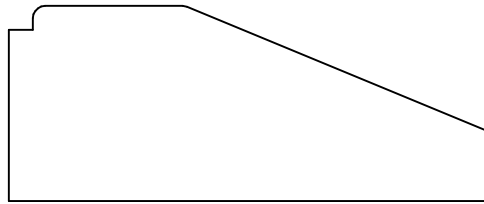

KL 5583
1.015 x 2.500

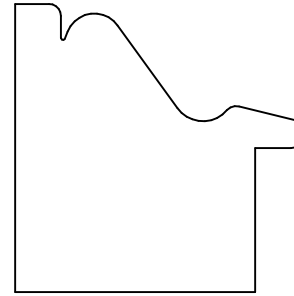

KL 5584
1.500 x 1.500

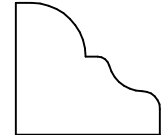

KL 5593
.687 x .750

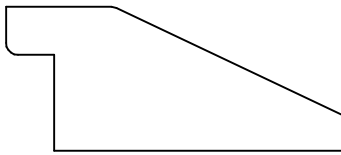

KL 5585
.750 x 1.750

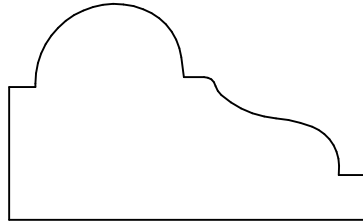

KL 5586
1.125 x 1.875

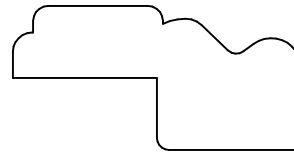

KL 5589
.750 x 1.500



KL 6511
.250 x .750



KL 6525
.250 x .500

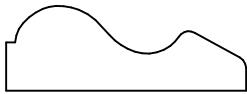

KL 5590
.442 x 1.250



KL 5592
.500 x 2.000

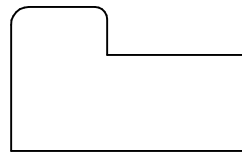

KL 5594
.750 x 1.250

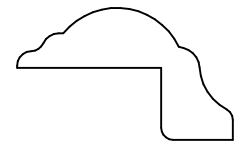

KL 5596
.687 x 1.125

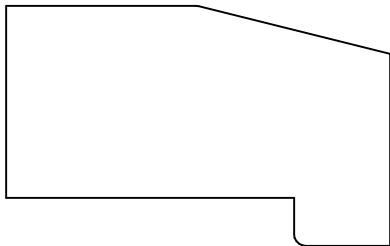

KL 5595
1.250 x 2.000

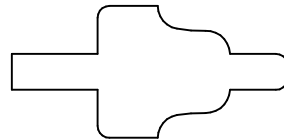

KL 5598
.688 x 1.437

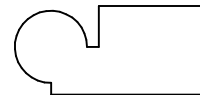

KL 5599
.462 x 1.000



KL 6502
.375 x 1.000

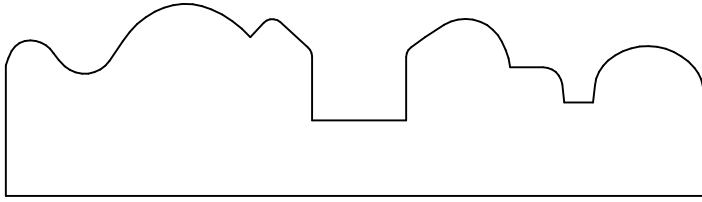

KL 6501
1.000 x 3.632

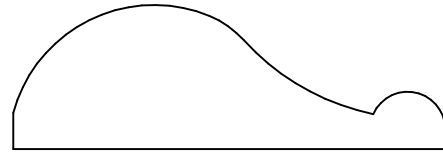

KL 6503
.750 x 2.250

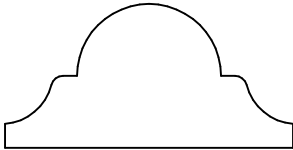

KL 6504
.750 x 1.500

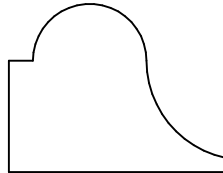

KL 6505
.875 x 1.125

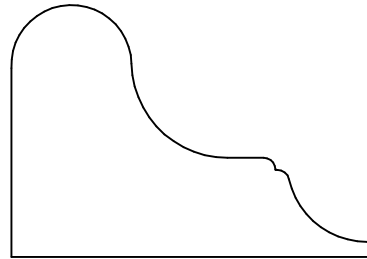

KL 6506
1.312 x 1.875

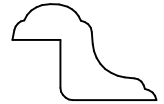

KL 6515
.500 x .750

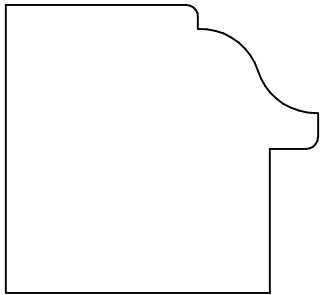

KL 6507
1.500 x 1.625

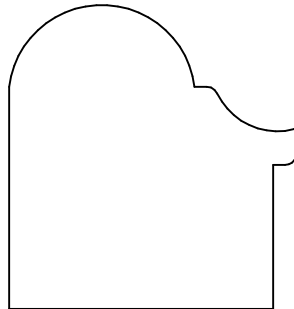

KL 6508
1.582 x 1.500

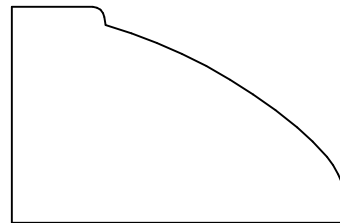

KL 6510
1.125 x 1.750

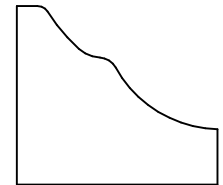

KL 6513
.930 x 1.045

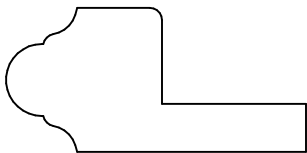

KL 6512
.750 x 1.562

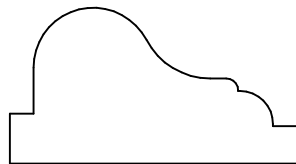

KL 6514
.812 x 1.500

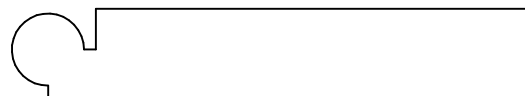

KL 6517
.462 x 2.687

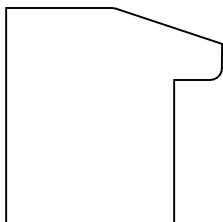

KL 6518
1.125 x 1.125

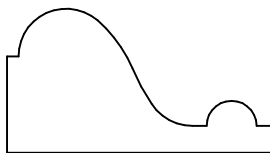

KL 6520
.750 x 1.375



KL 6521
.486 x .750

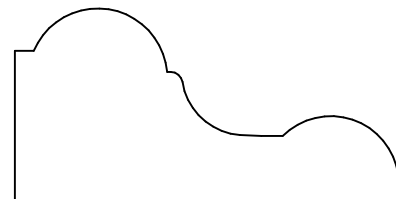

KL 6522
1.000 x 2.000



KL 6534
.312 x .875

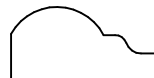

KL 6530
.375 x .750

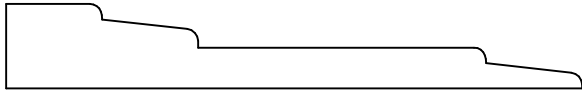

KL 6523
.440 x 3.000

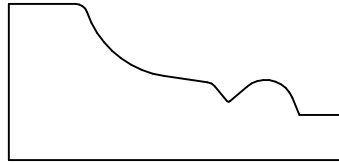

KL 6524
.812 x 1.750

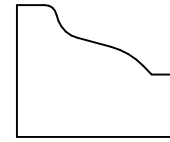

KL 6527
.687 x .812

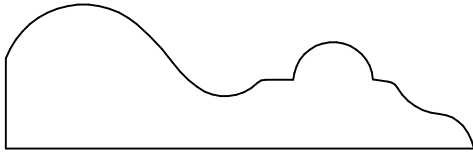

KL 6526
.750 x 2.437

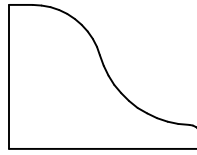

KL 6529
.750 x 1.000



KL 6538
.500 x .875

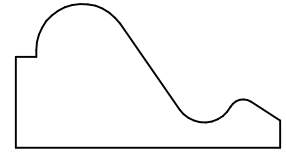

KL 6528
.750 x 1.375

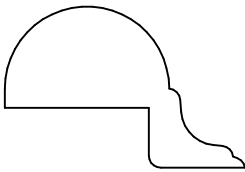

KL 6531
.840 x 1.250

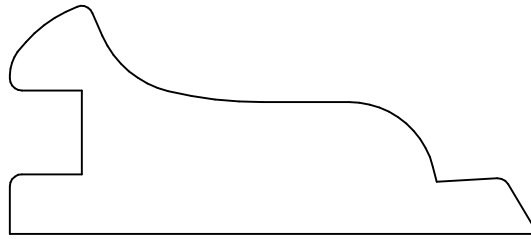

KL 6533
1.187 x 2.750

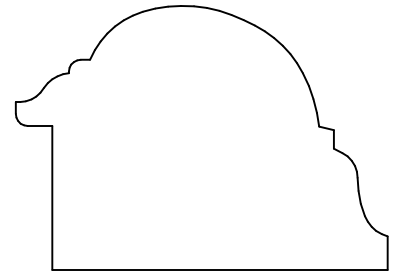

KL 6535
1.375 x 1.937

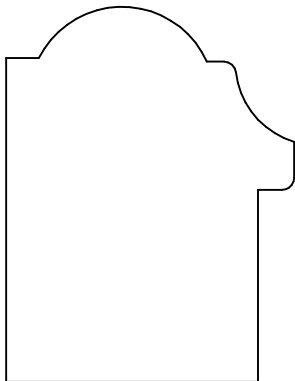

KL 6532
1.953 x 1.500

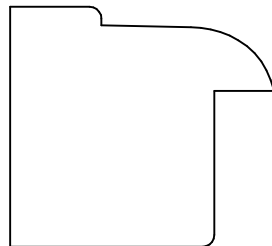

KL 6536
1.250 x 1.375

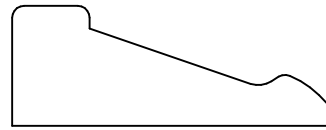

KL 6537
.625 x 1.687

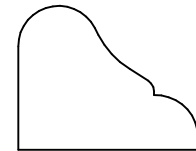

KL 6542
.750 x .937

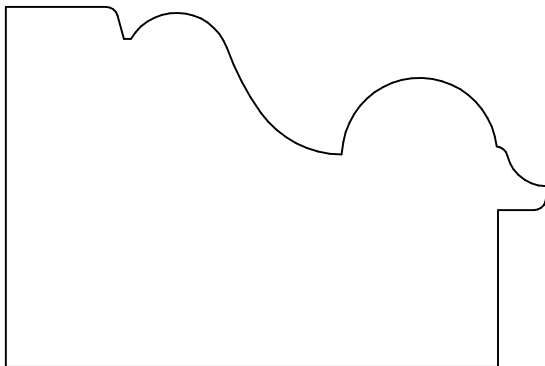

KL 6539
1.875 x 2.812

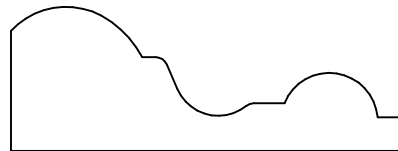

KL 6540
.750 x 2.062

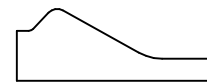

KL 6544
.375 x 1.000



KL 6545
.437 x 1.000



KL 6548
.500 x .730

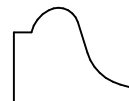

KL 6555
.500 x .625

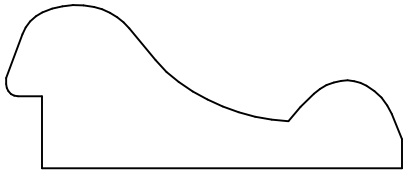

KL 6541
.850 x 2.062

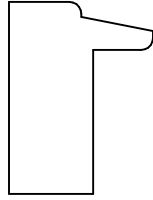

KL 6543
1.000 x .750

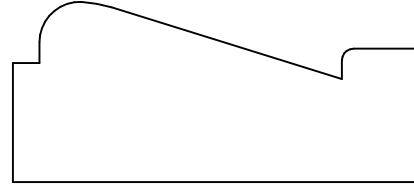

KL 6546
.937 x 2.125

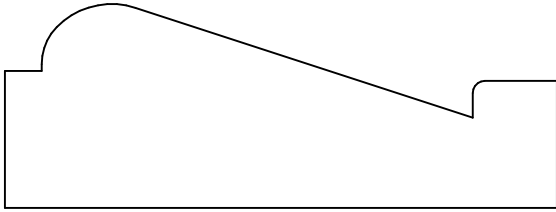

KL 6547
1.062 x 2.875



KL 6549
.514 x 1.476



KL 6550
.540 x 1.574

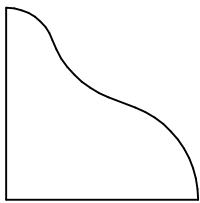

KL 6552
1.000 x 1.000

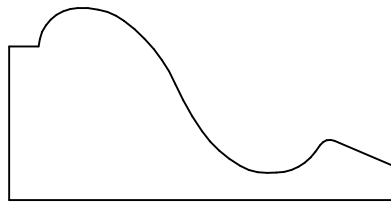

KL 6553
1.000 x 2.000

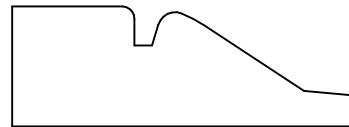

KL 6554
.625 x 1.812

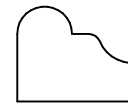

KL 6561
.495 x .587

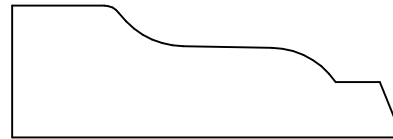

KL 6556
.687 x 2.031

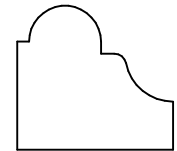

KL 6564
.749 x .812

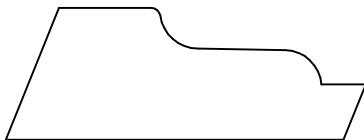

KL 6557
.687 x 1.875



KL 6558
.500 x 1.500

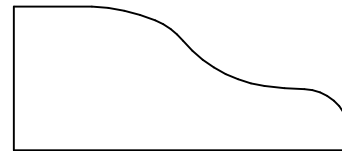

KL 6559
.750 x 1.750



KL 6567
.500 x .750

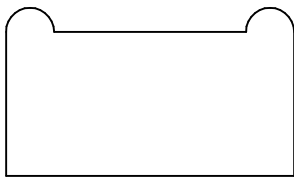

KL 6560
.875 x 1.500

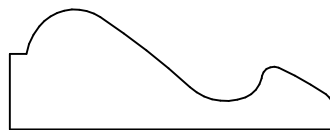

KL 6562
.625 x 1.687

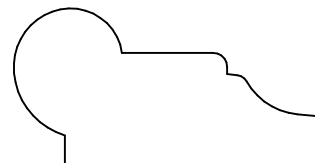

KL 6563
.812 x 1.625



KL 6565
.430 x 1.088



KL 6566
.687 x 1.000

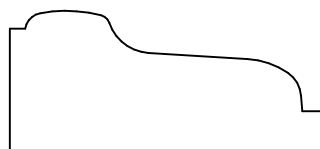

KL 6571
.750 x 1.625

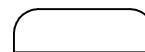

KL 6588
.225 x .730



KL 6573
.562 x .750

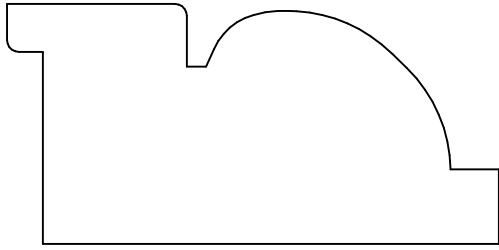

KL 6568
1.250 x 2.562

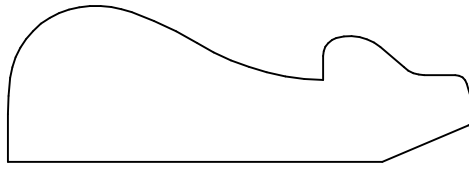

KL 6570
.812 x 2.437

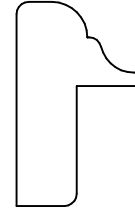

KL 6572
1.062 x .625

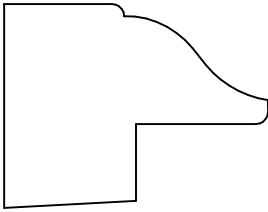

KL 6576
1.062 x 1.375

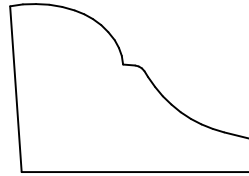

KL 6577
.875 x 1.250

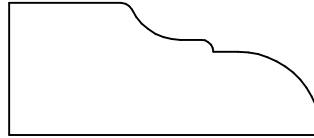

KL 6578
.687 x 1.625



KL 6580
.687 x 1.250

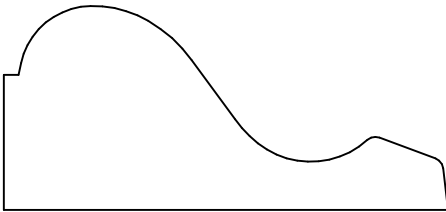

KL 6579
1.062 x 2.312

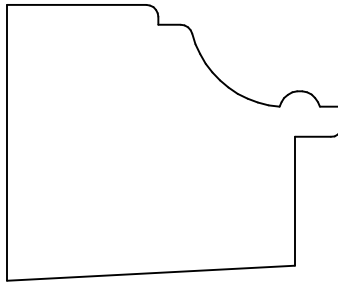

KL 6581
1.437 x 1.750

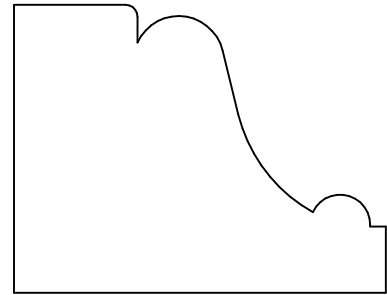

KL 6582
1.500 x 1.937

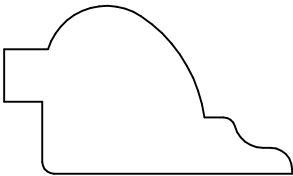

KL 6584
.875 x 1.500

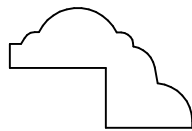

KL 6585
.625 x .950

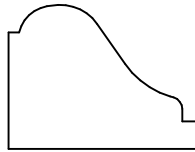

KL 6586
.750 x 1.000

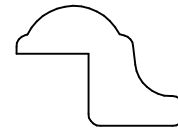

KL 6587
.625 x .875

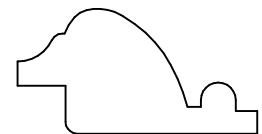

KL 6592
.650 x 1.250

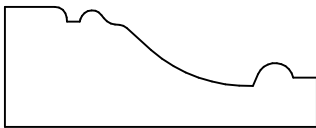

KL 6589
.625 x 1.625

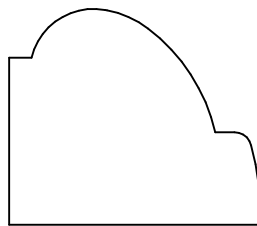

KL 6590
1.126 x 1.312

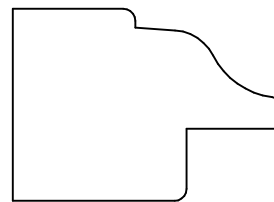

KL 6591
1.000 x 1.404

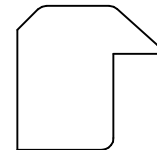

KL 6593
.750 x .750



KL 6599
.500 x .875

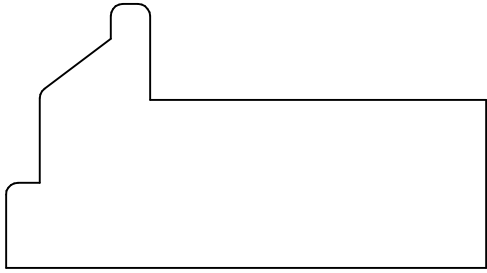

KL 6594
1.375 x 2.500

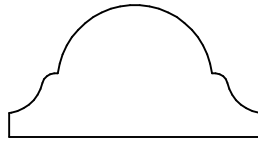

KL 6595
.687 x 1.312

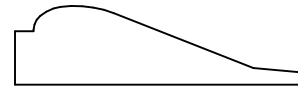

KL 7500
.410 x 1.500



KL 7506
.375 x .580

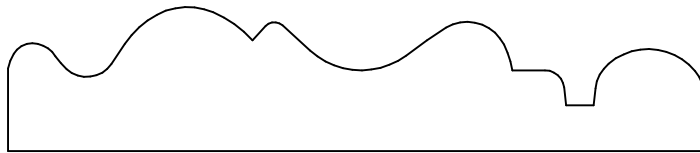

KL 6597
.750 x 3.625

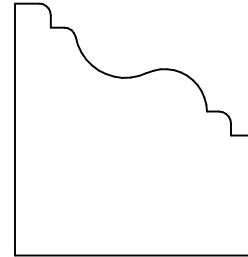

KL 7501
1.312 x 1.250

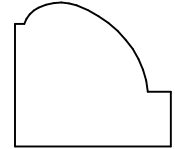

KL 7502
.750 x .812

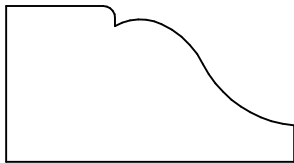

KL 7504
.812 x 1.500



KL 7507
.437 x .700



KL 7508
.320 x .615

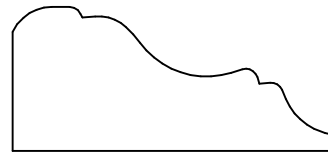

KL 7509
.750 x 1.687

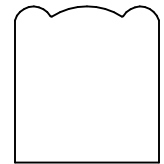

KL 7503
.812 x .750

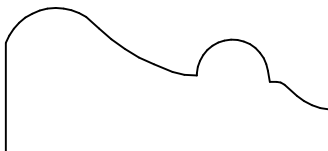

KL 7510
.750 x 1.684

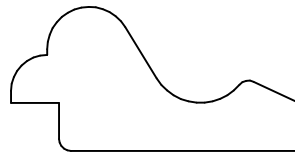

KL 7511
.750 x 1.500

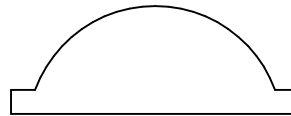

KL 7512
.563 x 1.500



KL 7513
.563 x .750

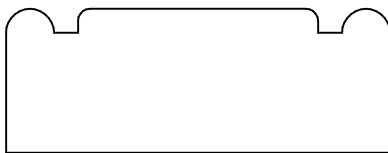

KL 7514
.750 x 2.000

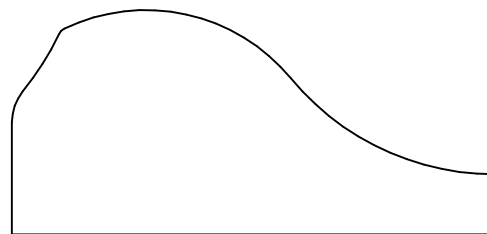

KL 7516
1.168 x 2.515

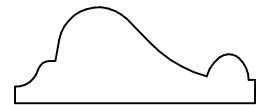

KL 7515
.500 x 1.250

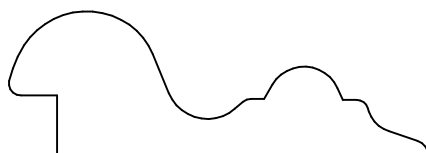

KL 7517
.750 x 2.186

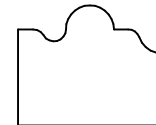

KL 7520
.625 x .750



KL 7522
.437 x .687

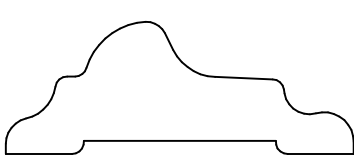

KL 7518
.687 x 1.812

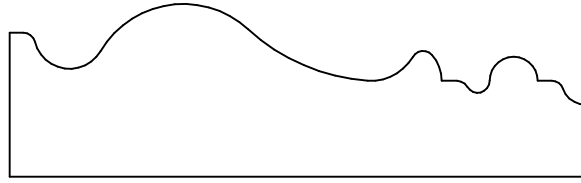

KL 7519
.900 x 3.000

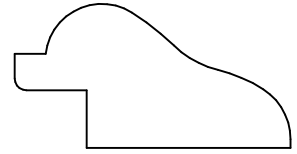

KL 7521
.750 x 1.437

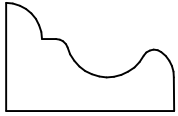

KL 7523
.563 x .875

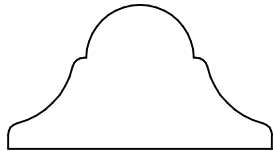

KL 7524
.750 x 1.375

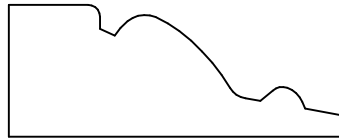

KL 7526
.687 x 1.750

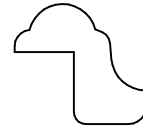

KL 7525
.625 x .687



KL 7558
.250 x .500

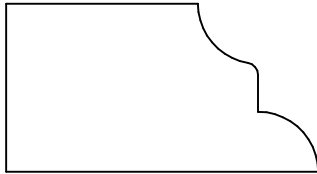

KL 7527
.875 x 1.625

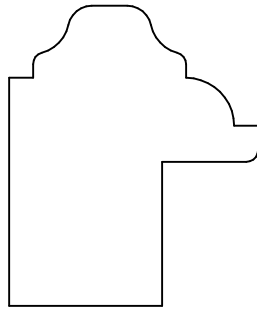

KL 7528
1.563 x 1.298

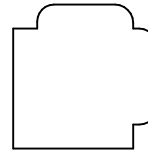

KL 7529
.750 x .750

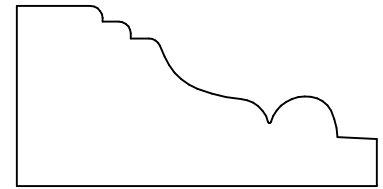

KL 7530
.937 x 1.875

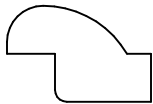

KL 7531
.500 x .750

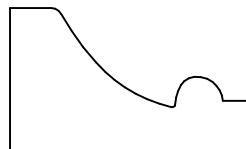

KL 7534
.750 x 1.250

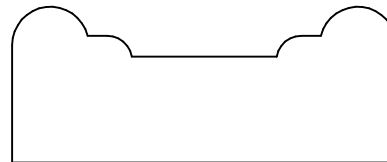

KL 7532
.812 x 2.000



KL 7555
.425 x .750

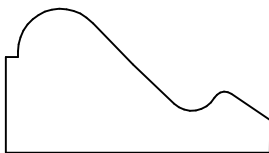

KL 7533
.750 x 1.375

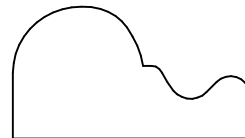

KL 7537
.687 x 1.250



KL 7538
.437 x 1.437



KL 7568
.250 x .500

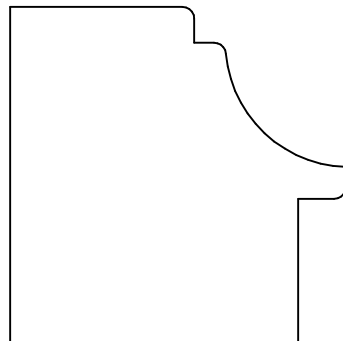

KL 7536
1.750 x 1.750

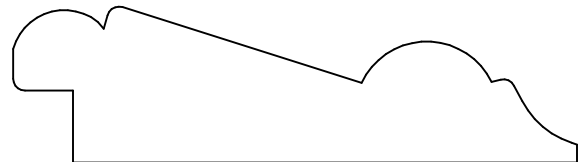

KL 7539
.805 x 2.937

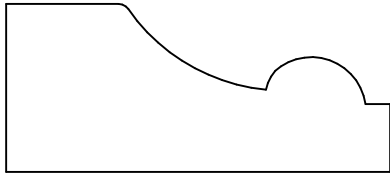

KL 7540
.875 x 2.000



KL 7541
.625 x 1.500

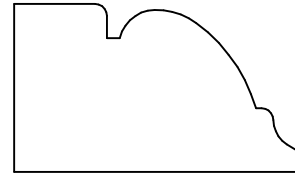

KL 7542
.875 x 1.500

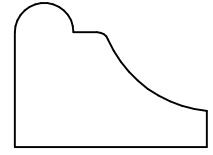

KL 7557
.750 x 1.000

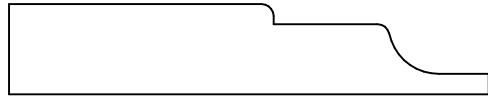

KL 7543
.470 x 2.500



KL 7544
.375 x 1.375

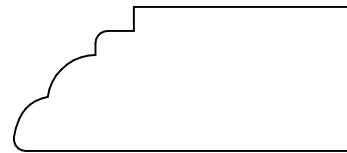

KL 7545
.750 x 1.750

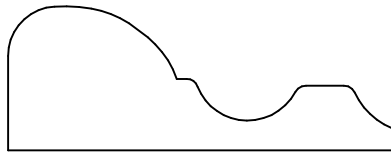

KL 7546
.750 x 2.000

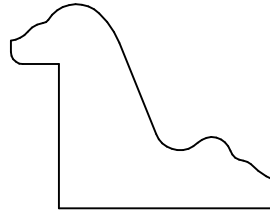

KL 7547
1.062 x 1.375

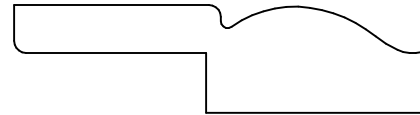

KL 7548
.562 x 2.125

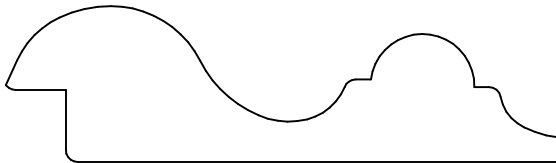

KL 7550
.812 x 2.875

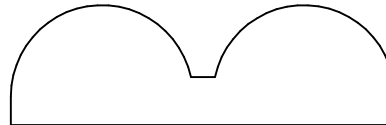

KL 7551
.625 x 2.000

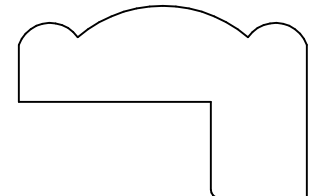

KL 7552
1.000 x 1.500

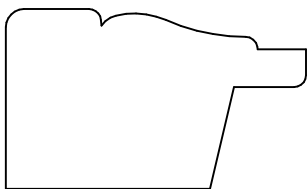

KL 7553
.937 x 1.562

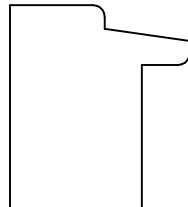

KL 7554
1.062 x .937

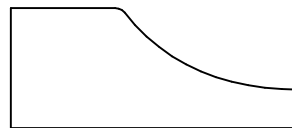

KL 7556
.625 x 1.500

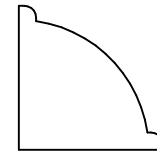

KL 7562
.750 x .750



KL 7563
.600 x .850



KL 7560
.500 x 2.250

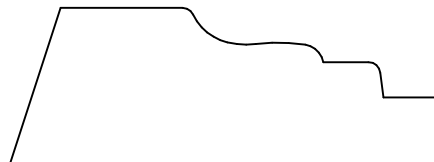

KL 7561
.812 x 2.250



KL 7564
.562 x 1.250

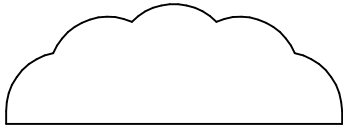

KL 7569
.625 x 1.750

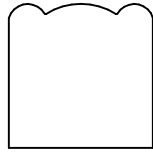

KL 7571
.750 x .750

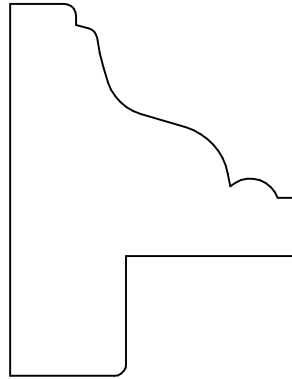

KL 7572
1.937 x 1.500

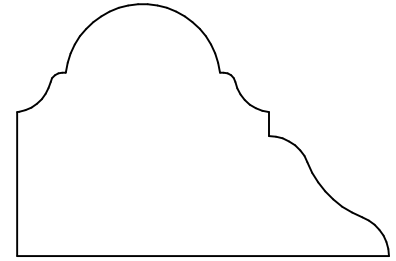

KL 7574
1.312 x 1.937

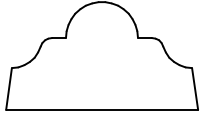

KL 7575
.563 x 1.000



KL 7580
.250 x .500

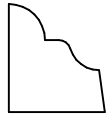

KL 7576
.563 x .500

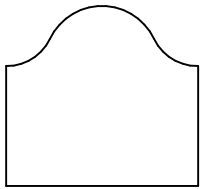

KL 7577
.938 x 1.000

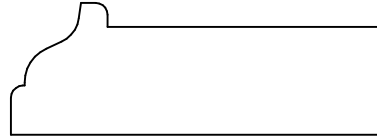

KL 7578
.687 x 1.937

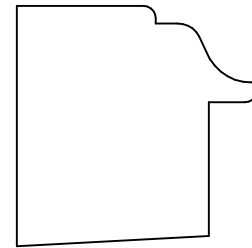

KL 7579
1.250 x 1.250



KL 9505
.235 x .375

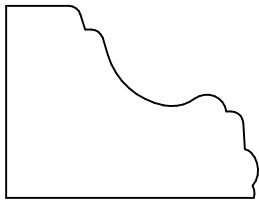

KL 7581
1.000 x 1.312

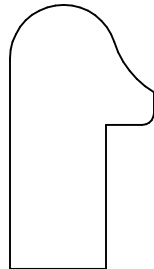

KL 7582
1.375 x .750

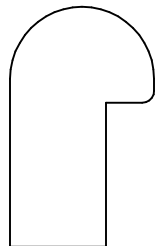

KL 7583
1.250 x .750

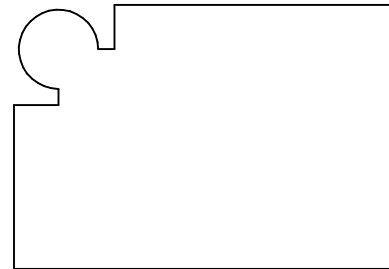

KL 7584
1.375 x 2.000

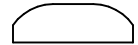

KL 7589
.200 x .625



KL 7590
.500 x .625

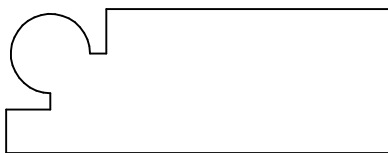

KL 7585
.750 x 2.000



KL 7586
.420 x 1.125

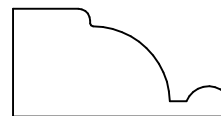

KL 7587
.562 x 1.125



KL 7588
.575 x 1.125

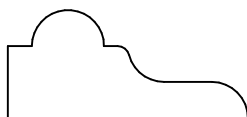

KL 7591
.563 x 1.250

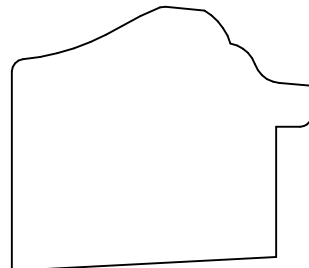

KL 7592
1.375 x 1.562

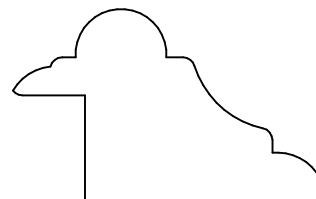

KL 7593
1.000 x 1.625

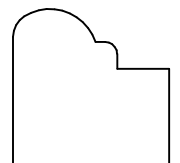

KL 7596
.812 x .812

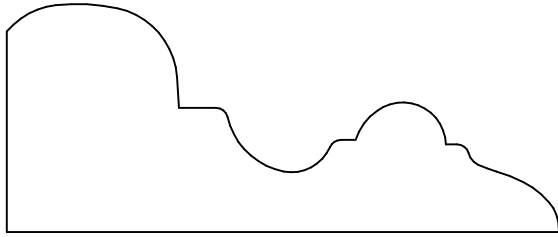

KL 7594
1.187 x 2.875

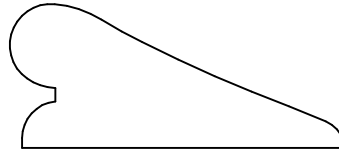

KL 7595
.750 x 1.750



KL 7598
.470 x .888

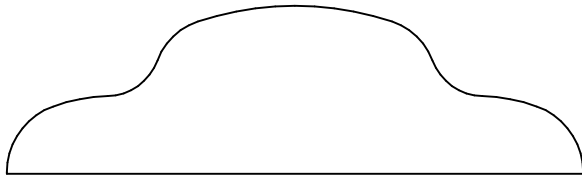

KL 7597
.875 x 3.000

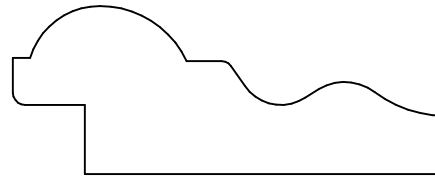

KL 7599
.875 x 2.250



KL 9504
.687 x 1.062



KL 9502
.562 x 2.250

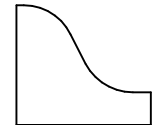

KL 9512
.625 x .700

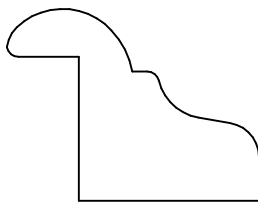

KL 9500
.750 x 1.312

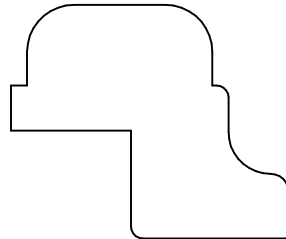

KL 9501
1.216 x 1.446

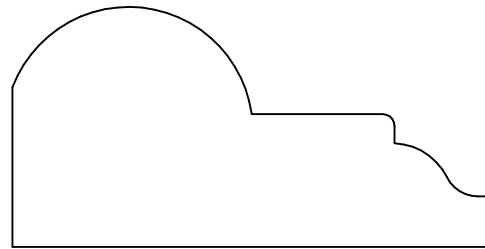

KL 9506
1.250 x 2.500



KL 9516
.291 x .505



KL 9518
.235 x .545

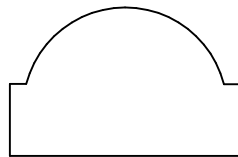

KL 9507
.774 x 1.199

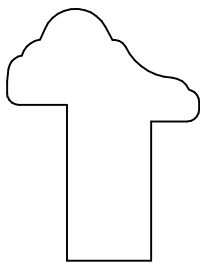

KL 9503
1.312 x 1.000

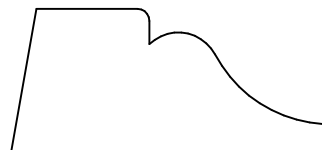

KL 9508
.750 x 1.625

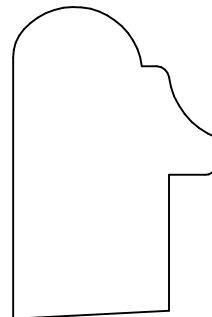

KL 9509
1.625 x 1.062

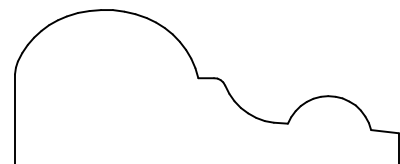

KL 9510
.812 x 2.000

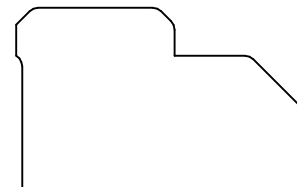

KL 9511
.950 x 1.500

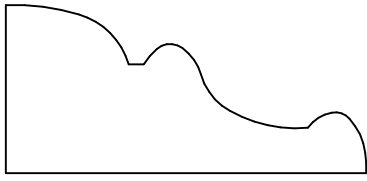

KL 9513
.875 x 1.875

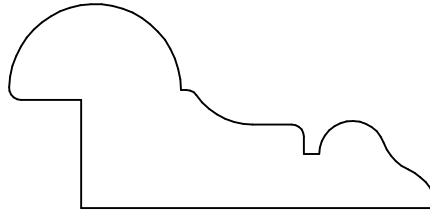

KL 9515
1.062 x 2.221

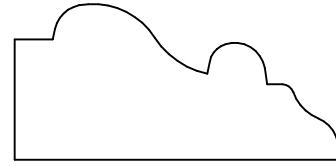

KL 9519
.812 x 1.687

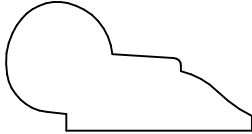

KL 9520
.670 x 1.277

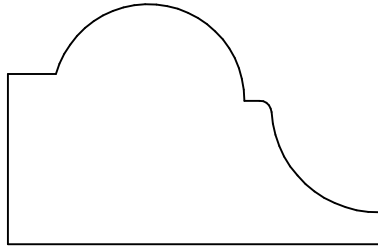

KL 9522
1.250 x 1.937

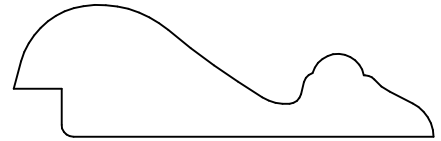

KL 9523
.687 x 2.187

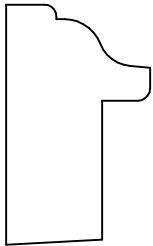

KL 9524
1.250 x .750

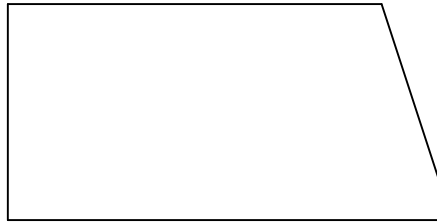

KL 9526
1.125 x 2.250

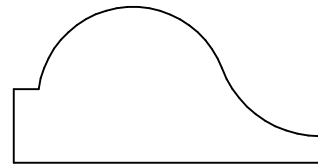

KL 9525
.812 x 1.625

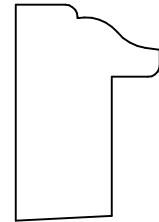

KL 9529
1.125 x .750

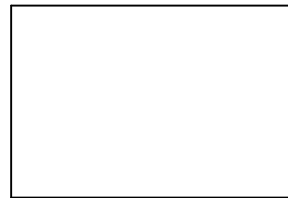

KL 9527
1.000 x 1.500

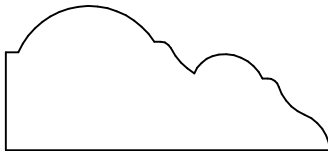

KL 9530
.750 x 1.687

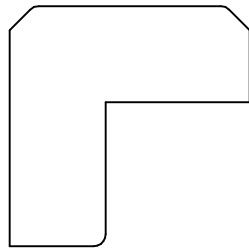

KL 9531
1.250 x 1.250

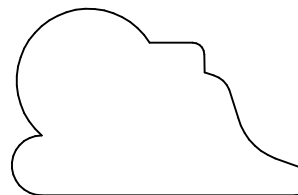

KL 9532
.972 x 1.541



KL 9533
.500 x 1.312

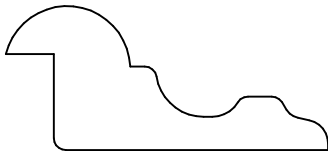

KL 9534
.750 x 1.678

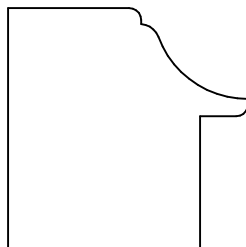

KL 9536
1.250 x 1.250

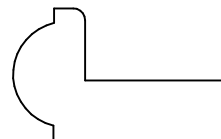

KL 9537
.687 x 1.125

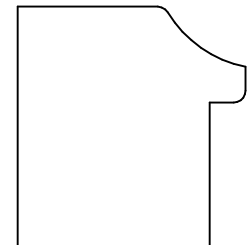

KL 9535
1.250 x 1.187

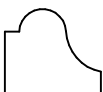

KL 9549
.437 x .500

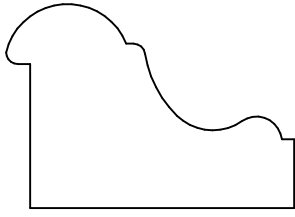

KL 9538
1.062 x 1.500

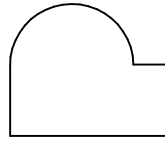

KL 9539
.687 x .812

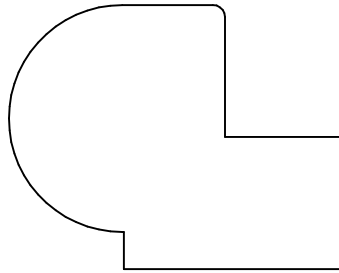

KL 9540
1.375 x 1.750



KL 9541
.972 x .719

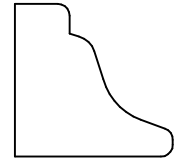

KL 9542
.795 x .822

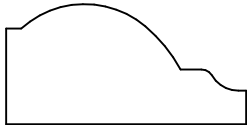

KL 9543
.625 x 1.250

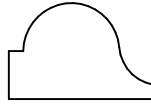

KL 9545
.500 x .750

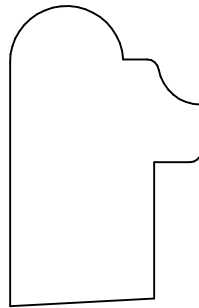

KL 9546
1.562 x 1.000

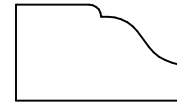

KL 9547
.500 x .875

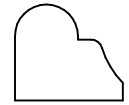

KL 9551
.500 x .562

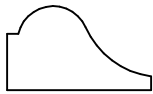

KL 9548
.437 x .750

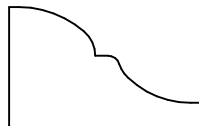

KL 9552
.625 x 1.000

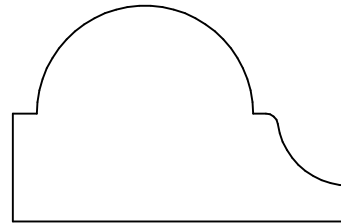

KL 9550
1.125 x 1.750

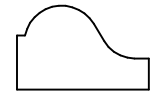

KL 9553
.437 x .687



KL 9556
.183 x .282

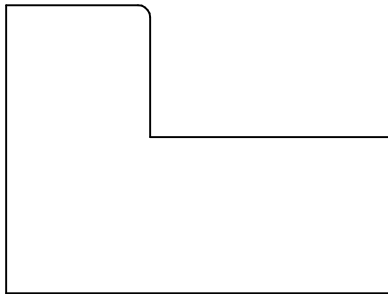

KL 9554
1.500 x 2.000

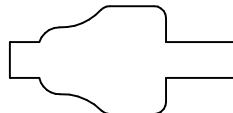

KL 9555
.562 x 1.187

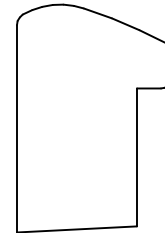

KL 9557
1.187 x .812

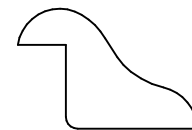

KL 9558
.625 x .939

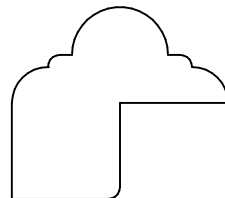

KL 9559
1.000 x 1.125

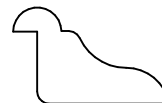

KL 9561
.500 x .812

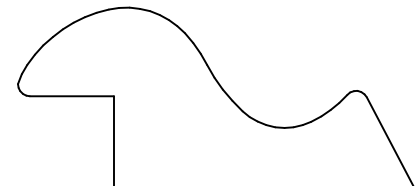

KL 9562
.937 x 2.062

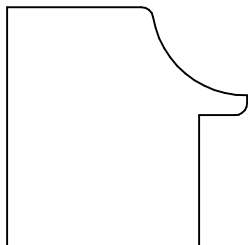

KL 9560
1.250 x 1.250

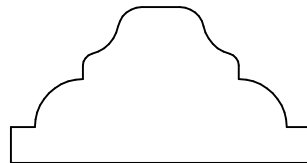

KL 9563
.812 x 1.562



KL 9564
.437 x .750



KL 9565
.375 x 1.000

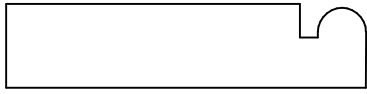

KL 9567
.437 x 1.875



KL 9568
.500 x 1.062

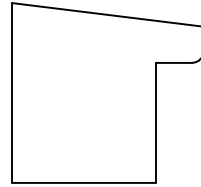

KL 9569
.937 x 1.000

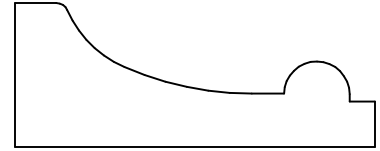

KL 9570
.750 x 1.875

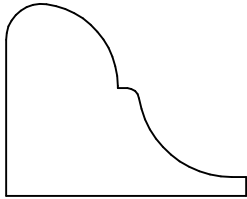

KL 9571
1.000 x 1.250



KL 9572
.500 x .750

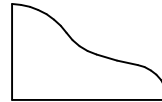

KL 9583
.500 x .812

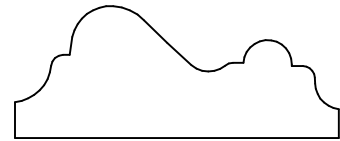

KL 9573
.687 x 1.687

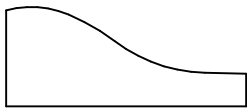

KL 9582
.517 x 1.250

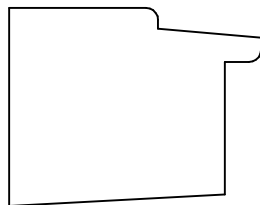

KL 9574
1.031 x 1.312

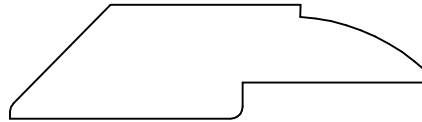

KL 9575
.593 x 2.188

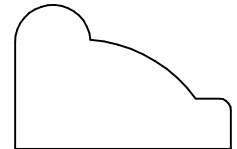

KL 9577
.750 x 1.125

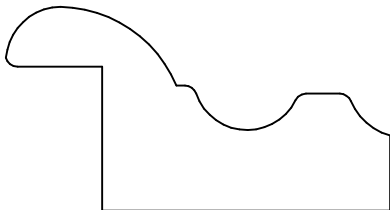

KL 9576
1.062 x 2.000

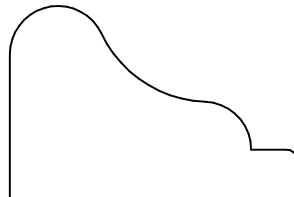

KL 9578
1.000 x 1.500

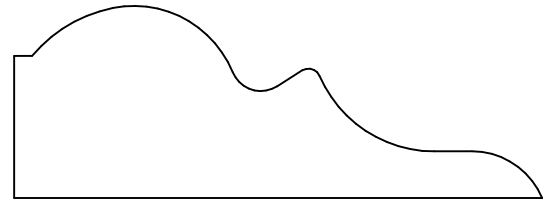

KL 9579
1.000 x 2.750

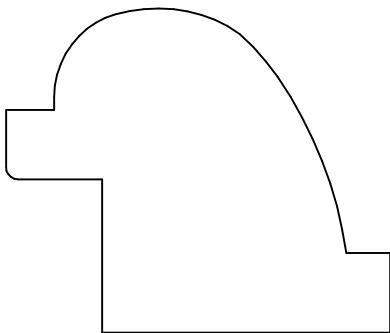

KL 9580
1.687 x 2.000



KL 9581
.625 x .937

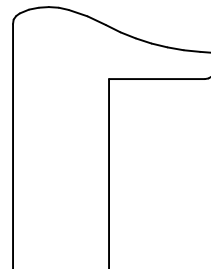

KL 9584
1.375 x 1.062



KL 9585
.312 x .750

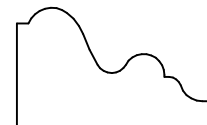

KL 9586
.625 x 1.000

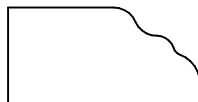

KL 9588
.500 x 1.000

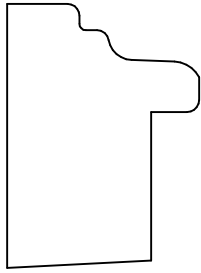

KL 9587
1.375 x 1.000

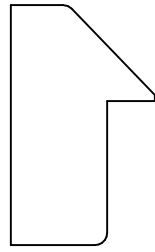

KL 9589
1.250 x .750

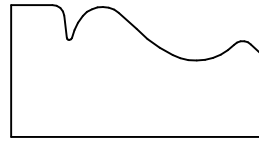

KL 9590
.687 x 1.312



KL 9591
.500 x 1.500

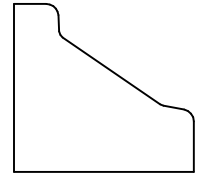

KL 9592
.875 x .937

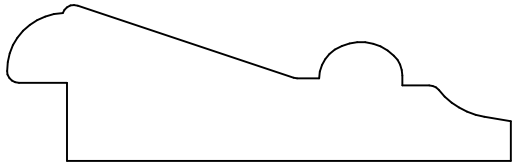

KL 9593
.812 x 2.625

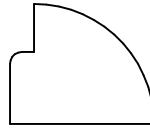

KL 9598
.625 x .750

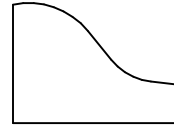

KL 9596
.625 x .875

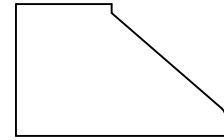

KL 9597
.687 x 1.093

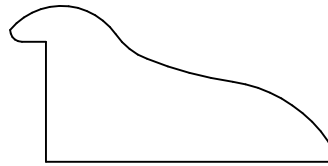

KL 9599
.812 x 1.687

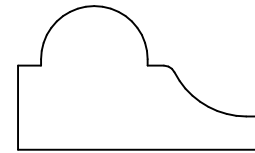

KL 11501
.750 x 1.250

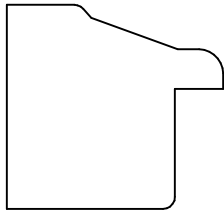

KL 11500
1.062 x 1.125

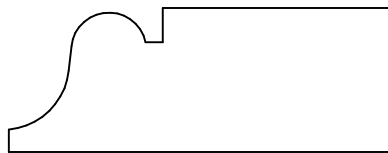

KL 11502
.750 x 2.000

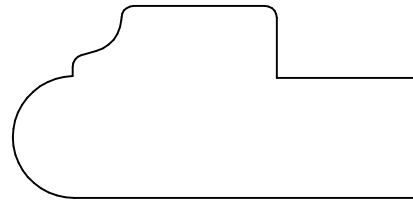

KL 11504
1.000 x 2.125

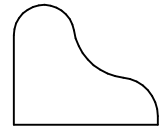

KL 11507
.625 x .750

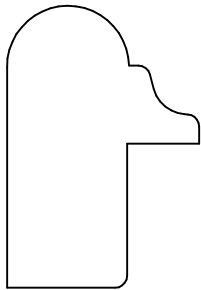

KL 11503
1.469 x 1.000

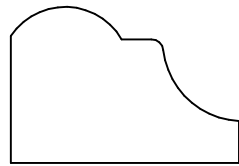

KL 11505
.812 x 1.187



KL 11506
.687 x 1.250

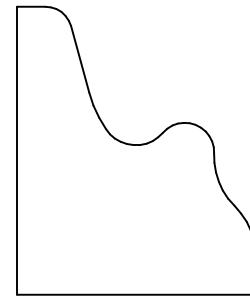

KL 11508
1.500 x 1.250



KL 11512
.625 x .750

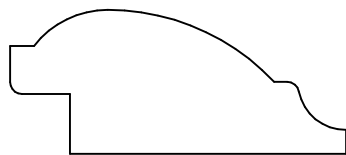

KL 11509
.750 x 1.750

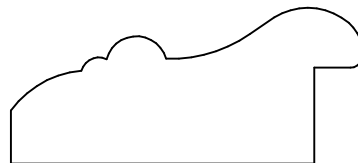

KL 11510
.812 x 1.829

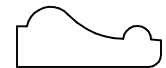

KL 11516
.312 x .750

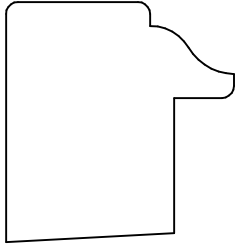

KL 11511
1.250 x 1.187

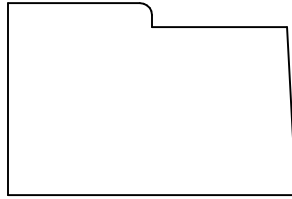

KL 11513
1.000 x 1.500

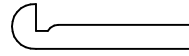

KL 11517
.234 x .937

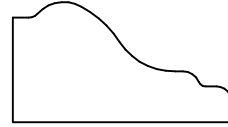

KL 11519
.625 x 1.156

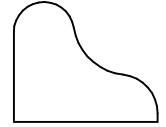

KL 11527
.625 x .750

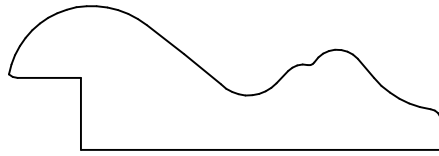

KL 11521
.750 x 2.250

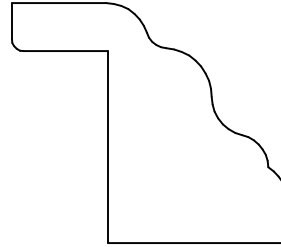

KL 11522
1.250 x 1.437

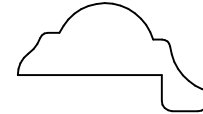

KL 11523
.562 x 1.000

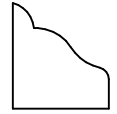

KL 11547
.551 x .500

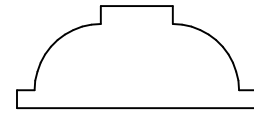

KL 11524
.531 x 1.250

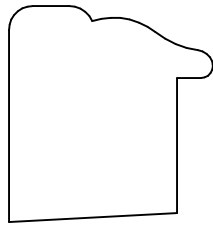

KL 11525
1.125 x 1.062

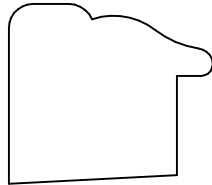

KL 11526
.937 x 1.062



KL 11528
.531 x 1.000

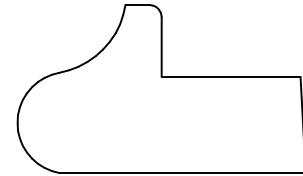

KL 11530
.875 x 1.500

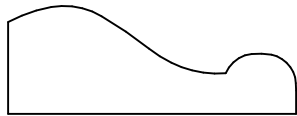

KL 11531
.562 x 1.500



KL 11537
.245 x .538

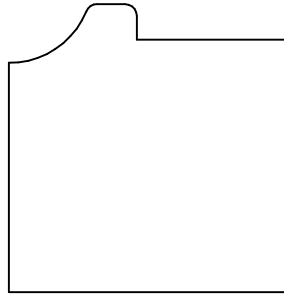

KL 11529
1.500 x 1.483

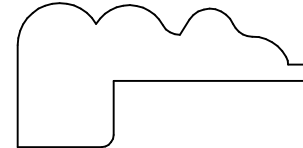

KL 11532
.750 x 1.500

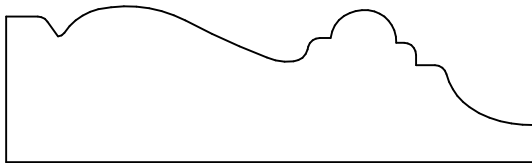

KL 11533
.812 x 2.750

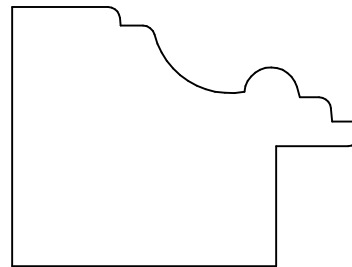

KL 11534
1.350 x 1.812

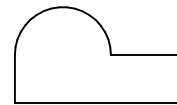

KL 11535
.500 x .875



KL 11540
.500 x .714

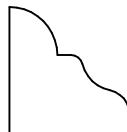

KL 11541
.656 x .625

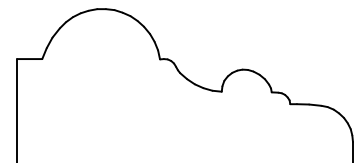

KL 11538
.812 x 1.750

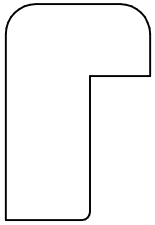

KL 11539
1.125 x .750

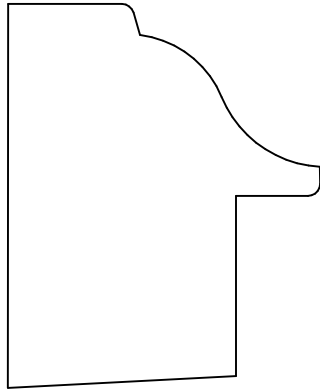

KL 11542
2.000 x 1.625

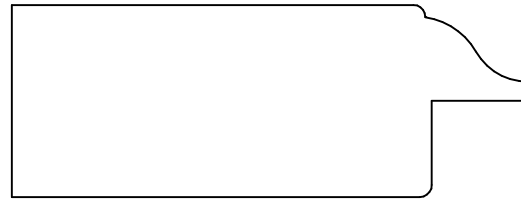

KL 11543
1.000 x 2.687

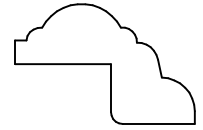

KL 11544
.625 x .937

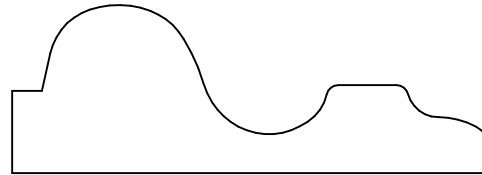

KL 11545
.875 x 2.500

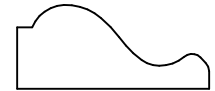

KL 11546
.437 x 1.000

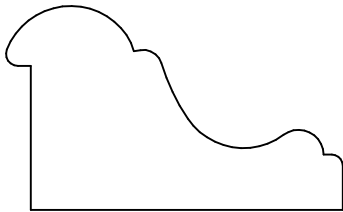

KL 11548
1.062 x 1.750



KL 11549
.500 x 1.250

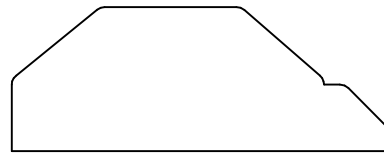

KL 11550
.750 x 1.972

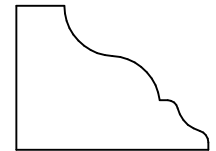

KL 11552
.750 x 1.000

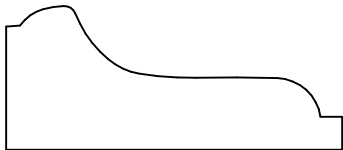

KL 11551
.750 x 1.750

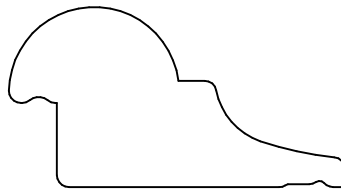

KL 11553
1.000 x 1.937

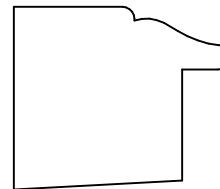

KL 11554
.950 x 1.125

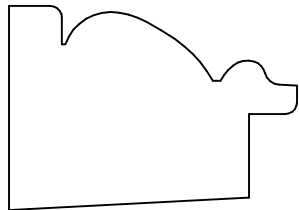

KL 11556
1.063 x 1.500



KL 11557
.621 x 1.596

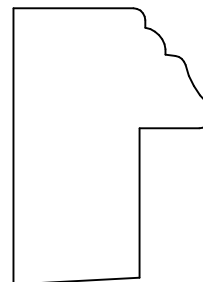

KL 11558
1.437 x 1.031

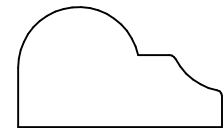

KL 11555
.625 x 1.062



KL 11561
.746 x 1.336



KL 11559
.534 x .750

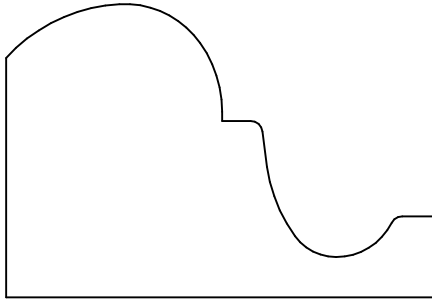

KL 11560
1.528 x 2.227

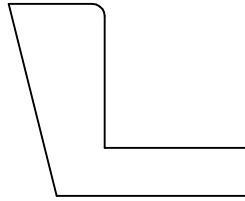

KL 11562
1.000 x 1.250

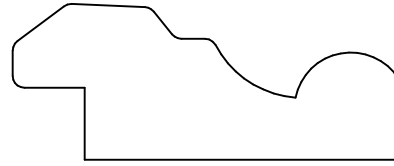

KL 11563
.812 x 2.000



KL 13536
.219 x .250

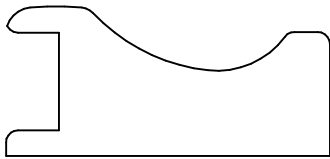

KL 11564
.778 x 1.687

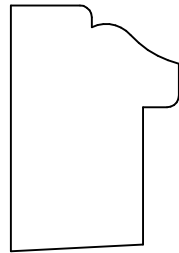

KL 11566
1.281 x .875



KL 11587
.250 x .500

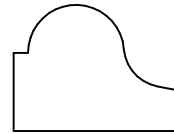

KL 11565
.656 x .875

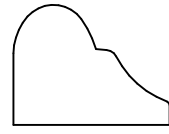

KL 11567
.625 x .812

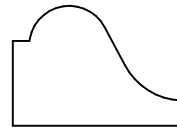

KL 11568
.625 x .875

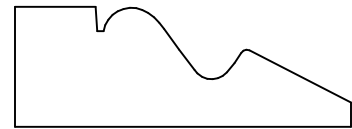

KL 11569
.625 x 1.750

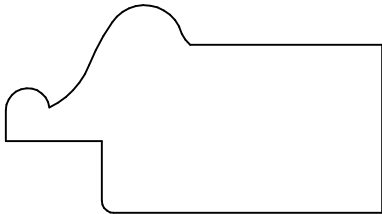

KL 11570
1.082 x 1.959

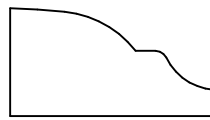

KL 11571
.562 x 1.062

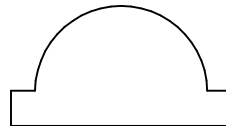

KL 11572
.750 x 1.147

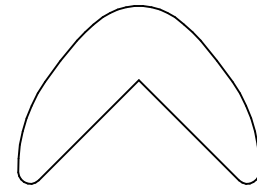

KL 11573
.923 x 1.256

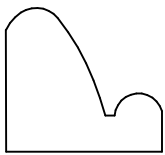

KL 11574
.750 x .812

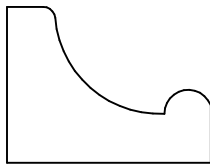

KL 11575
.812 x 1.062

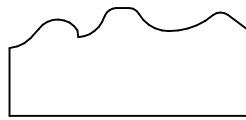

KL 11576
.562 x 1.250

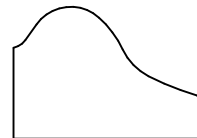

KL 11577
.687 x 1.000

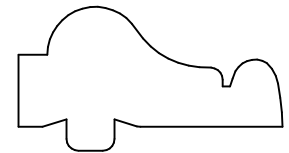

KL 11578
.625 x 1.375

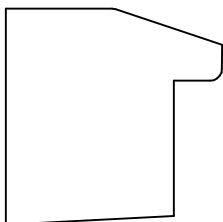

KL 11579
1.125 x 1.125



KL 11580
.889 x 2.029

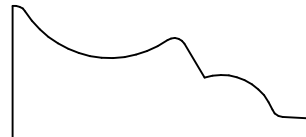

KL 11581
.687 x 1.562

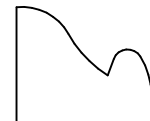

KL 11582
.598 x .730

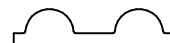

KL 11588
.188 x .840

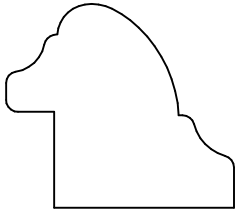

KL 11583
1.062 x 1.187

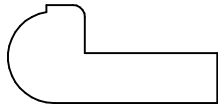

KL 11584
.510 x 1.090

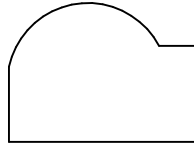

KL 11585
.723 x .975

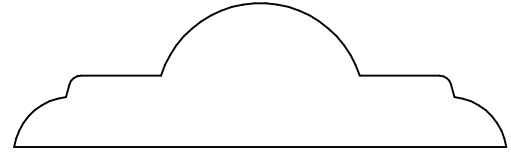

KL 11586
.750 x 2.562

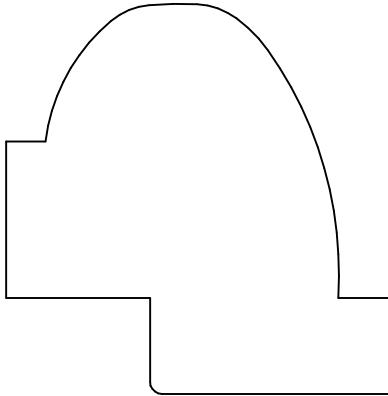

KL 11589
2.031 x 2.000

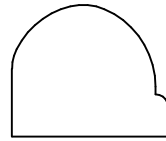

KL 11590
.687 x .812

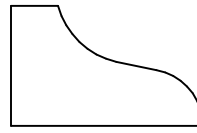

KL 11591
.625 x 1.000



KL 11592
.625 x .625

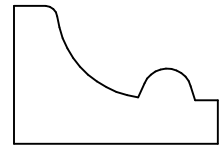

KL 11594
.718 x 1.062

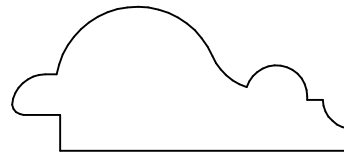

KL 11596
.750 x 1.750

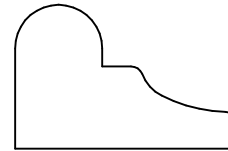

KL 11597
.750 x 1.156



KL 13500
.625 x 1.000

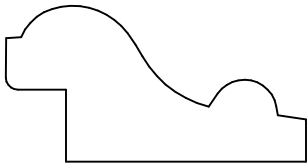

KL 11598
.812 x 1.562

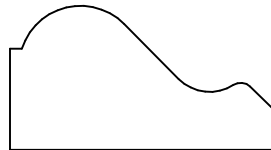

KL 11599
.750 x 1.375

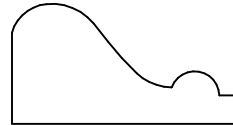

KL 13501
.625 x 1.187

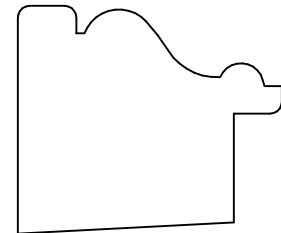

KL 13502
1.187 x 1.375

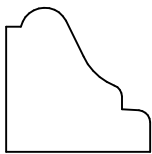

KL 13503
.750 x .750



KL 13504
.312 x .500

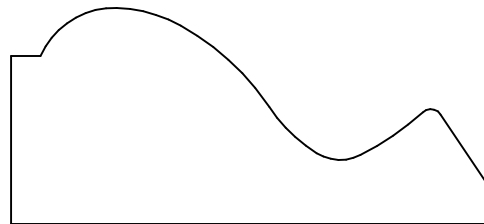

KL 13505
1.125 x 2.500

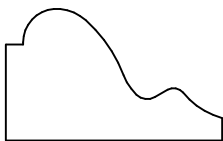

KL 13507
.687 x 1.125

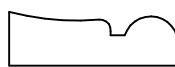

KL 13512
.281 x .875

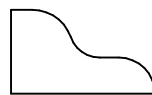

KL 13513
.437 x .750

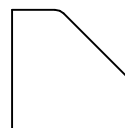

KL 13518
.625 x .625

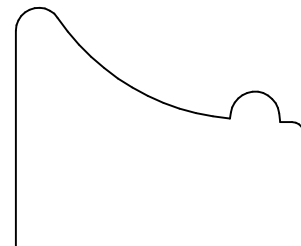

KL 13506
1.250 x 1.500

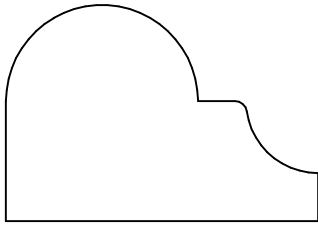

KL 13508
1.125 x 1.625

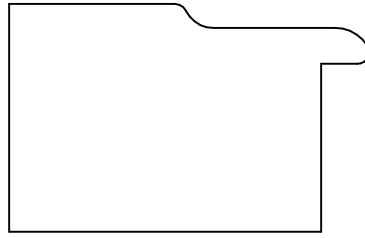

KL 13509
1.187 x 1.875

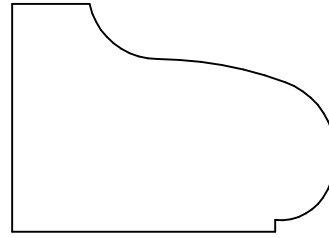

KL 13510
1.187 x 1.687

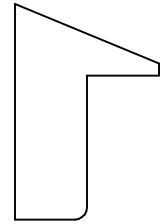

KL 13516
1.123 x .750

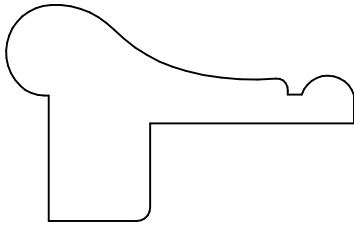

KL 13511
1.125 x 1.812



KL 13519
.406 x .750

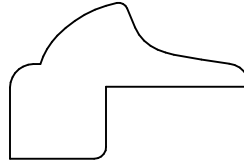

KL 13520
.812 x 1.250

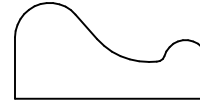

KL 13521
.500 x 1.000

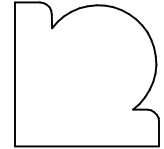

KL 13522
.750 x .750



KL 13524
.500 x .939

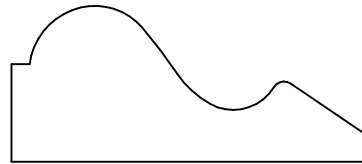

KL 13525
.813 x 1.875

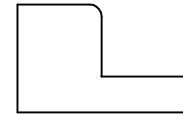

KL 13533
.562 x .875

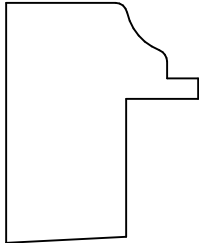

KL 13523
1.250 x 1.000

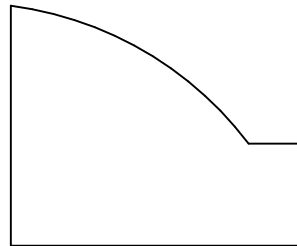

KL 13527
1.250 x 1.500

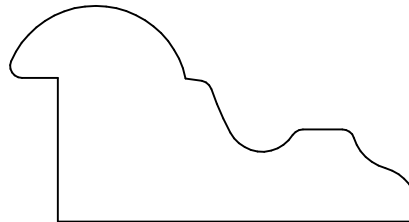

KL 13528
1.125 x 2.125

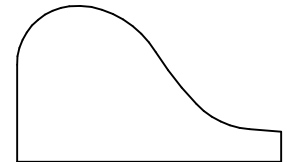

KL 13530
.812 x 1.375

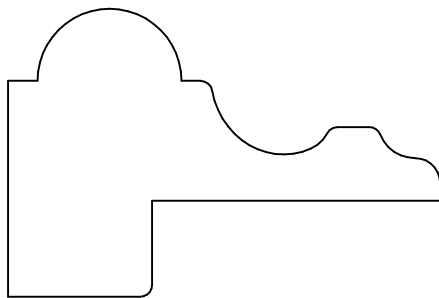

KL 13529
1.500 x 2.250

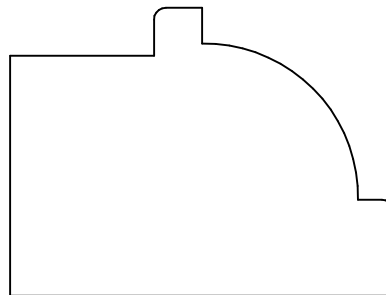

KL 13531
1.500 x 2.000

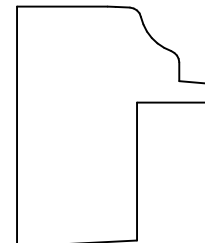

KL 13532
1.250 x 1.000

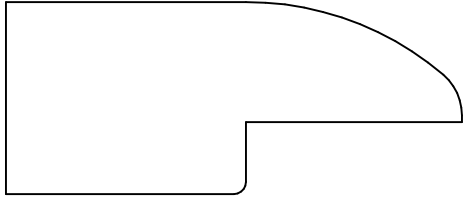

KL 13534
1.000 x 2.375

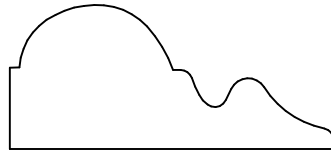

KL 13535
.750 x 1.687

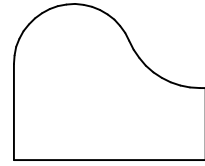

KL 13537
.813 x 1.000

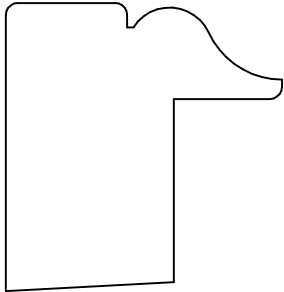

KL 13538
1.500 x 1.438

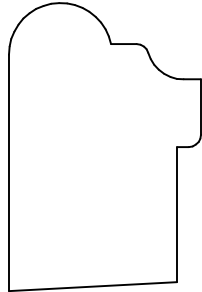

KL 13539
1.500 x 1.000

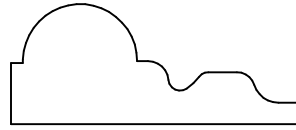

KL 13540
.625 x 1.500

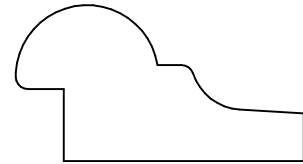

KL 13541
.812 x 1.500

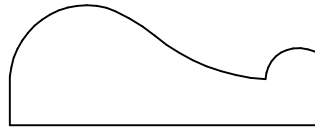

KL 13542
.625 x 1.625

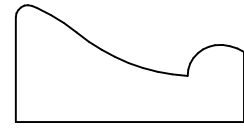

KL 13543
.608 x 1.187

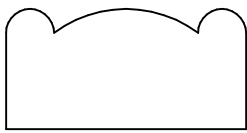

KL 13544
.625 x 1.250

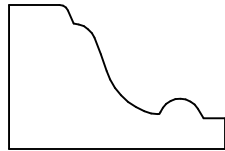

KL 13545
.750 x 1.125

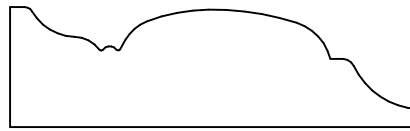

KL 13546
.625 x 2.125

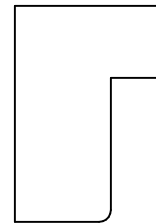

KL 13548
1.125 x .750

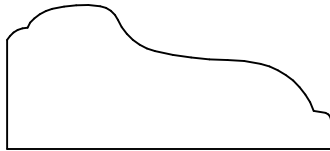

KL 13547
.750 x 1.687

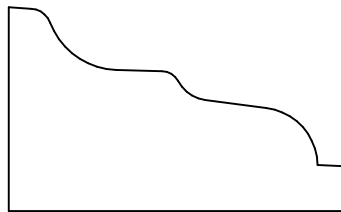

KL 13549
1.062 x 1.750

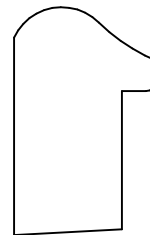

KL 13551
1.187 x .749



KL 13552
.385 x .750

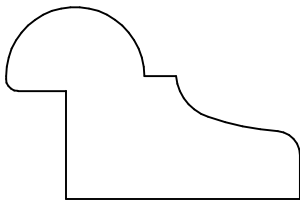

KL 13550
1.000 x 1.531

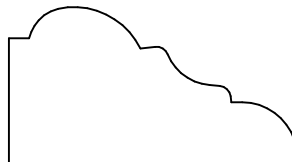

KL 13553
.812 x 1.500

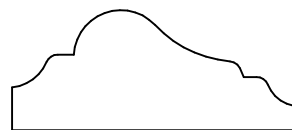

KL 13554
.625 x 1.500

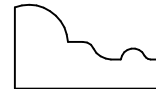

KL 13555
.437 x .750



KL 13566
.500 x .750

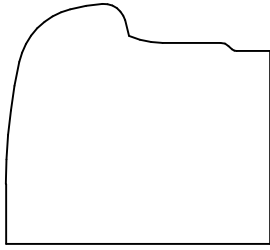

KL 13556
1.250 x 1.375



KL 13557
.625 x 1.000

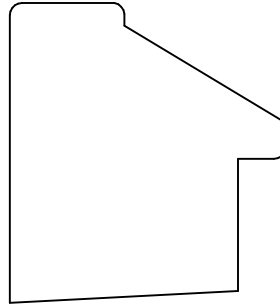

KL 13558
1.562 x 1.437

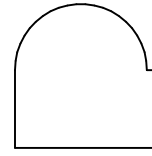

KL 13559
.750 x .750

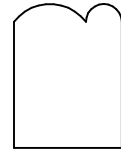

KL 13565
.750 x .562

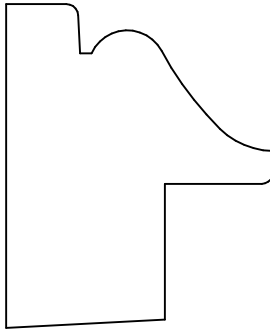

KL 13560
1.687 x 1.390

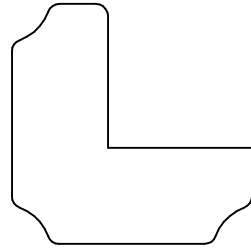

KL 13562
1.250 x 1.250



KL 13563
.500 x 1.250

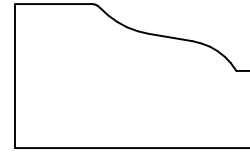

KL 13561
.750 x 1.250

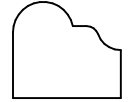

KL 13590
.500 x .562

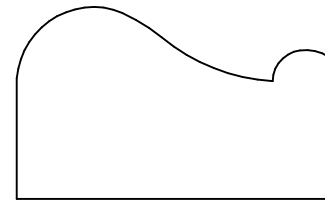

KL 13564
1.000 x 1.625

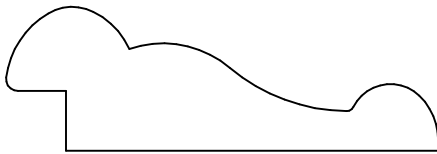

KL 13567
.750 x 2.250

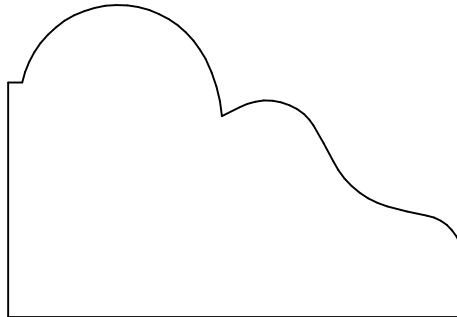

KL 13568
1.625 x 2.375

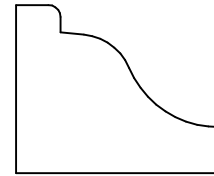

KL 13571
.875 x 1.062

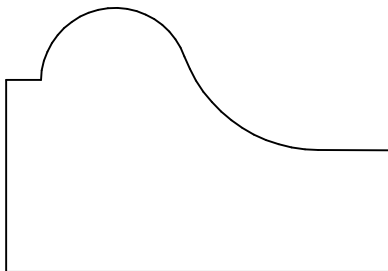

KL 13569
1.375 x 2.000



KL 13573
.468 x 1.125



KL 13576
.625 x .750

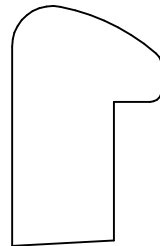

KL 13572
1.250 x .781

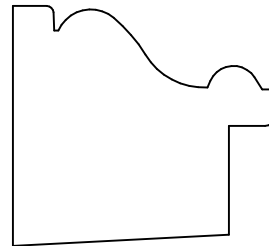

KL 13574
1.250 x 1.375

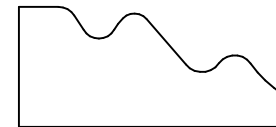

KL 13577
.625 x 1.375

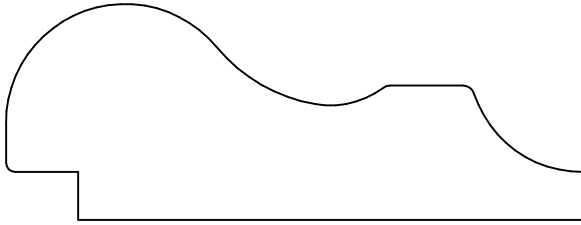

KL 13575
1.125 x 3.000

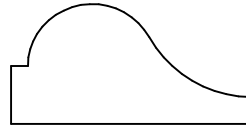

KL 13580
.625 x 1.250

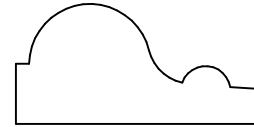

KL 13581
.625 x 1.250

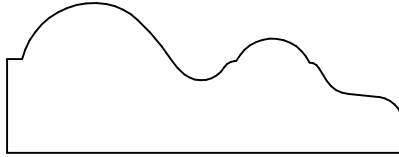

KL 13582
.781 x 2.062

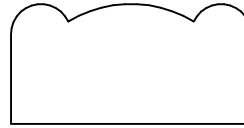

KL 13583
.625 x 1.250

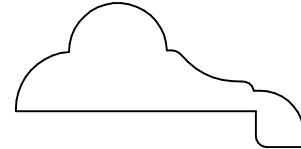

KL 13585
.750 x 1.500

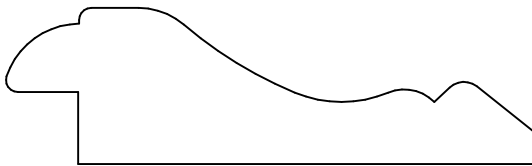

KL 13584
.813 x 2.750

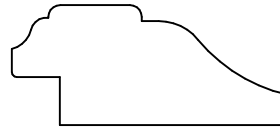

KL 13586
.625 x 1.437

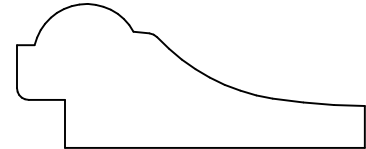

KL 13587
.750 x 1.812



KL 13589
.625 x .875

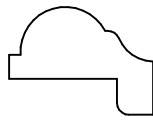

KL 13592
.562 x .750

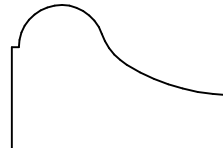

KL 13588
.750 x 1.125

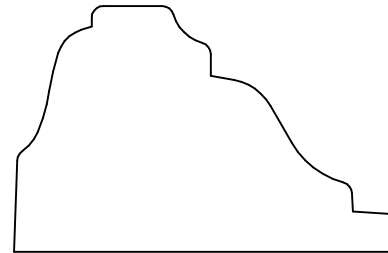

KL 13591
1.281 x 1.968

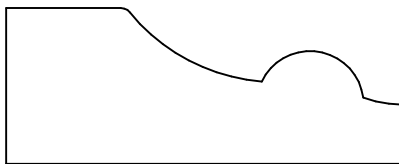

KL 13593
.812 x 2.062

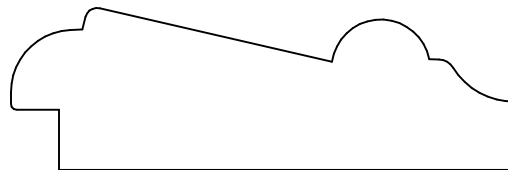

KL 13594
.843 x 2.625

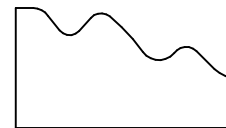

KL 13595
.625 x 1.125

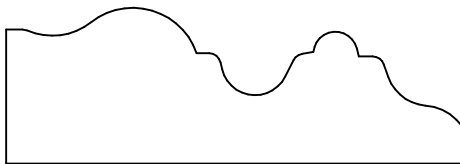

KL 13596
.812 x 2.375

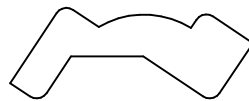

KL 13597
.472 x 1.265

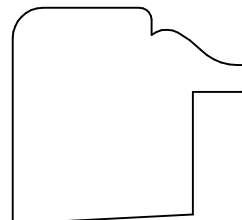

KL 13598
1.125 x 1.250



KL 14500
.750 x 1.000

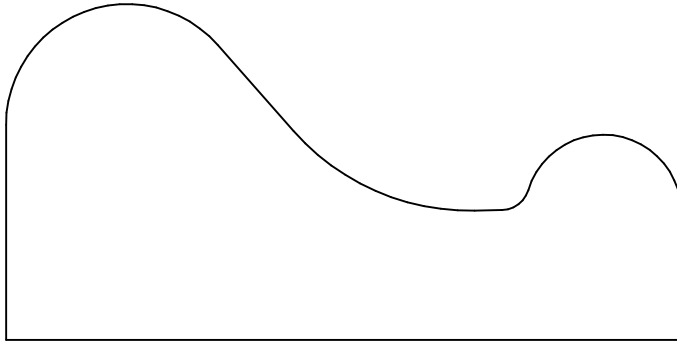

KL 13599
1.750 x 3.500

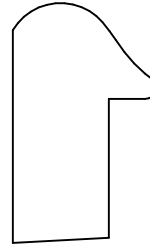

KL 14501
1.250 x .750

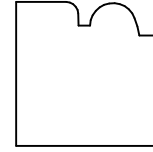

KL 14502
.750 x .750

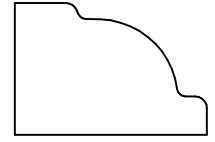

KL 14503
.687 x 1.000

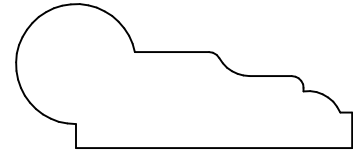

KL 14505
.750 x 1.750

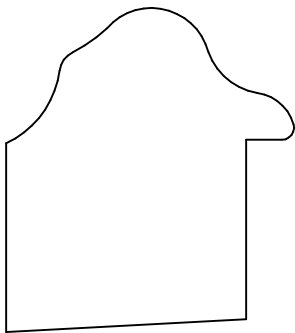

KL 14504
1.687 x 1.500

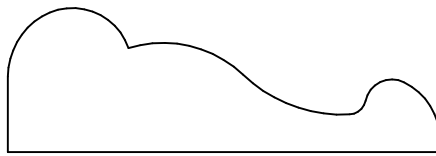

KL 14506
.750 x 2.250

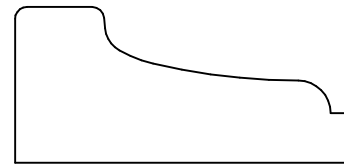

KL 14507
.812 x 1.750



KL 14513
.328 x .468

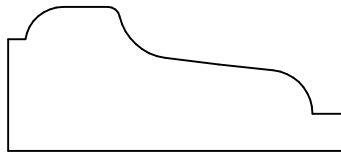

KL 14510
.750 x 1.750

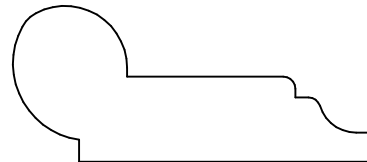

KL 14512
.812 x 1.875



KL 14520
.437 x .812

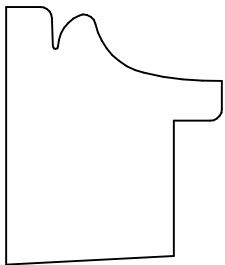

KL 14509
1.343 x 1.125

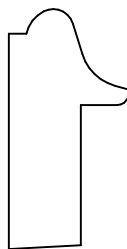

KL 14511
1.250 x .625

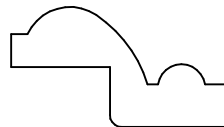

KL 14514
.625 x 1.125

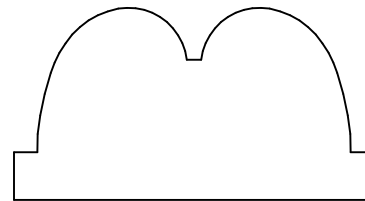

KL 14517
1.000 x 1.875

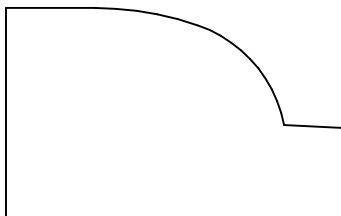

KL 14518
1.093 x 1.750

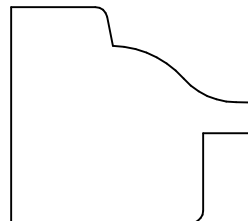

KL 14515
1.125 x 1.250

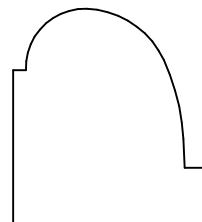

KL 14519
1.125 x 1.031

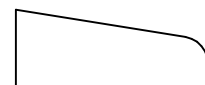

KL 14521
.406 x 1.000

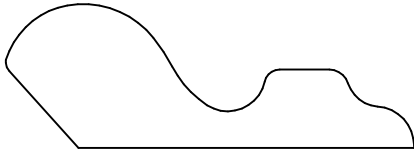

KL 14522
.750 x 2.125

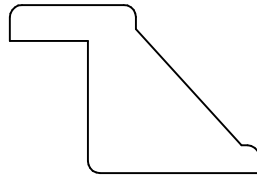

KL 14523
.875 x 1.300

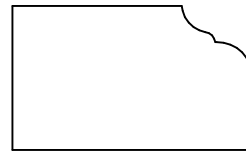

KL 14524
.750 x 1.250

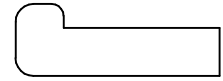

KL 14525
.375 x 1.062



KL 14529
.437 x .750

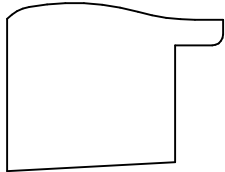

KL 14526
.875 x 1.125

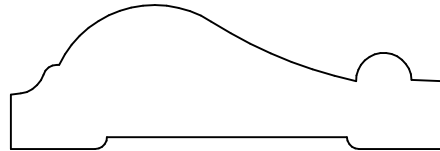

KL 14527
.750 x 2.250

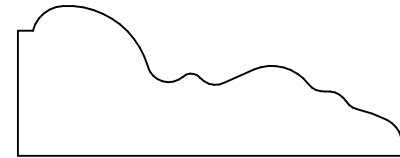

KL 14530
.781 x 2.000

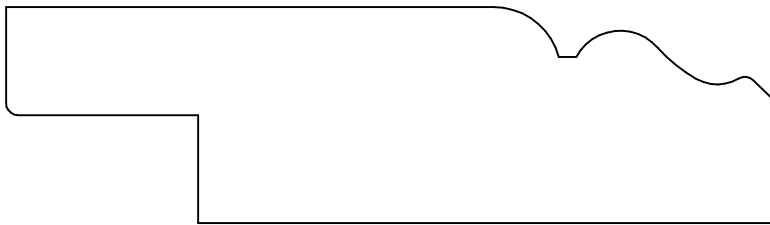

KL 14528
1.125 x 4.000

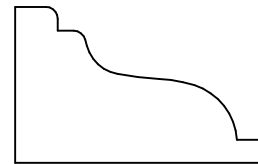

KL 14531
.812 x 1.312

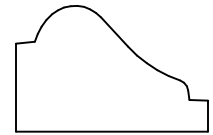

KL 14533
.656 x 1.000

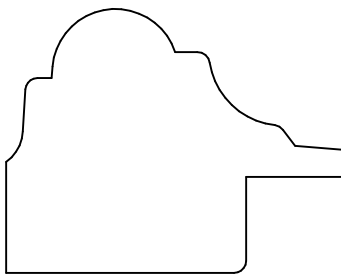

KL 14532
1.375 x 1.750

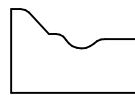

KL 14534
.437 x .656

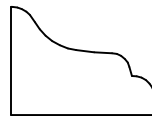

KL 14535
.562 x .750

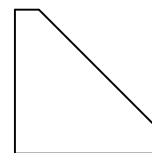

KL 14536
.750 x .750



KL 14538
.500 x .937

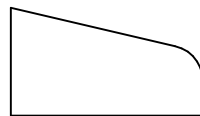

KL 14539
.562 x 1.000



KL 14541
.625 x 1.000

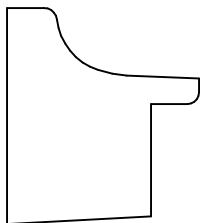

KL 14540
1.125 x 1.000



KL 14543
.437 x 1.125

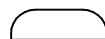

KL 14576
.156 x .500

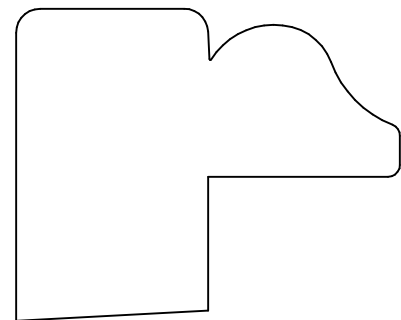

KL 14542
1.625 x 2.000

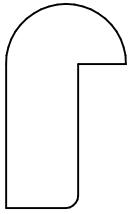

KL 14544
1.062 x .625

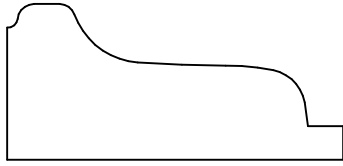

KL 14545
.812 x 1.750

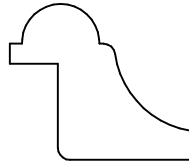

KL 14546
.812 x .937

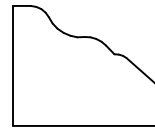

KL 14547
.625 x .765

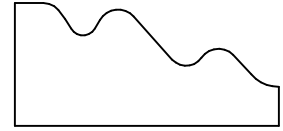

KL 14548
.640 x 1.375

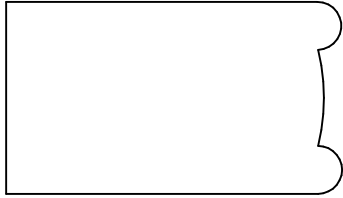

KL 14549
1.000 x 1.750



KL 14550
.500 x 3.500



KL 14551
.500 x .875



KL 14554
.625 x 1.250

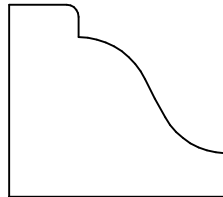

KL 14552
1.000 x 1.125



KL 14553
.687 x 3.250

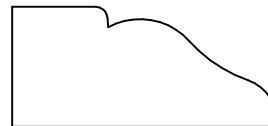

KL 14559
.625 x 1.375



KL 14565
.390 x .875

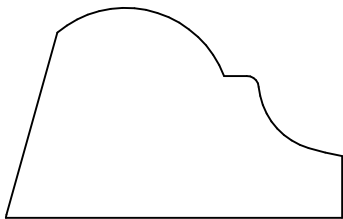

KL 14555
1.093 x 1.750

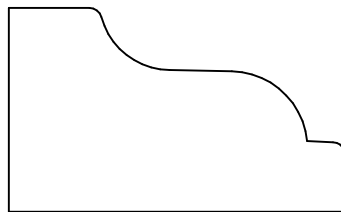

KL 14558
1.062 x 1.750

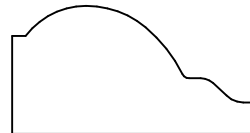

KL 14560
.668 x 1.270

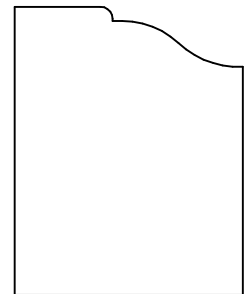

KL 14564
1.500 x 1.187

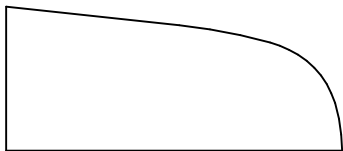

KL 14561
.750 x 1.750

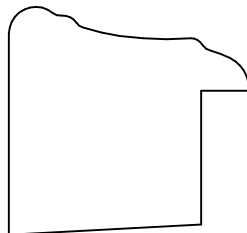

KL 14562
1.187 x 1.250

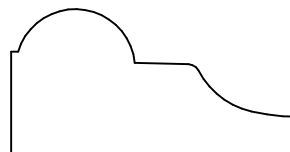

KL 14563
.750 x 1.500



KL 14567
.625 x .812

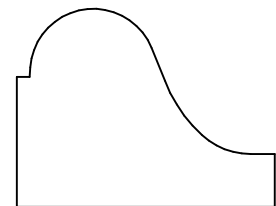

KL 14566
1.031 x 1.343

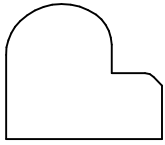

KL 14568
.703 x .812

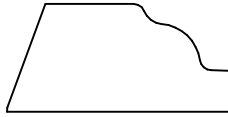

KL 14569
.562 x 1.156



KL 14570
.437 x .843



KL 14571
.375 x 1.531

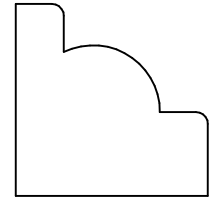

KL 14572
1.000 x 1.000

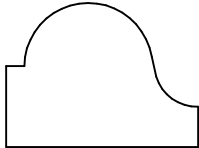

KL 14573
.750 x 1.000

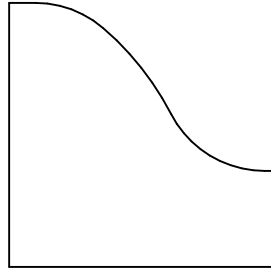

KL 14574
1.375 x 1.375



KL 15527
.343 x .421

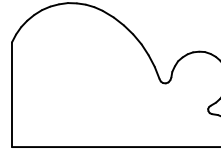

KL 14575
.750 x 1.125

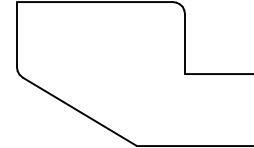

KL 14577
.750 x 1.250

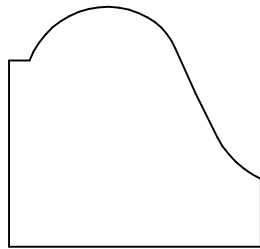

KL 14578
1.250 x 1.312

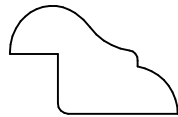

KL 14581
.562 x .875

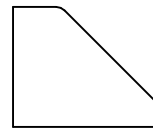

KL 14580
.625 x .750

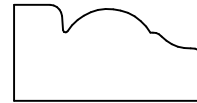

KL 14582
.500 x 1.000



KL 14583
.375 x .750

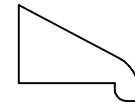

KL 14585
.500 x .625

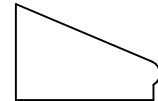

KL 14587
.500 x .750

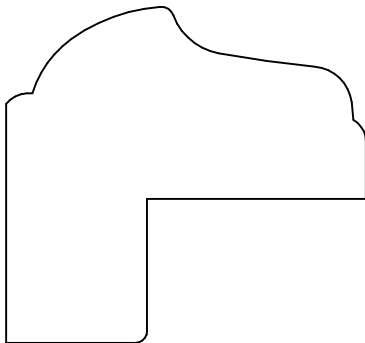

KL 14584
1.750 x 1.875

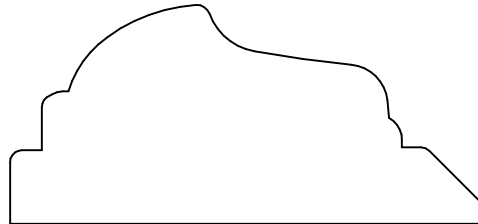

KL 14586
1.140 x 2.468



KL 14590
.656 x 1.125

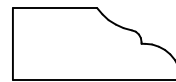

KL 15506
.375 x .875

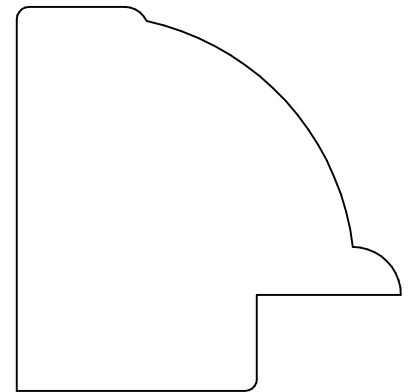

KL 14588
2.000 x 2.000

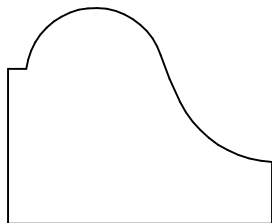

KL 14589
1.125 x 1.375

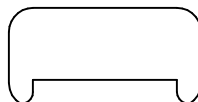

KL 14596
.500 x 1.000

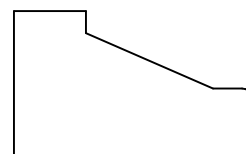

KL 14592
.750 x 1.250



KL 15537
.250 x .750

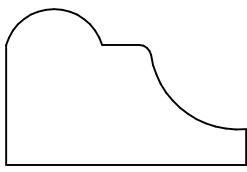

KL 14595
.812 x 1.250

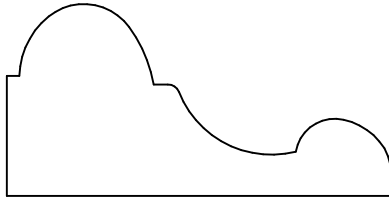

KL 14597
1.000 x 2.000

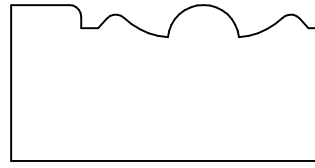

KL 14598
.812 x 1.625

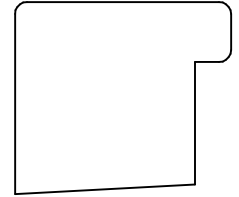

KL 15501
1.000 x 1.125

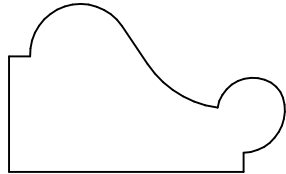

KL 14599
.875 x 1.437

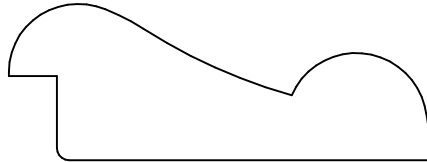

KL 15502
.813 x 2.187

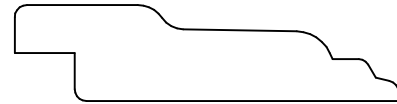

KL 15503
.500 x 2.000

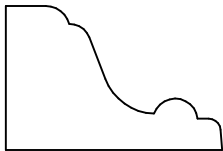

KL 15504
.750 x 1.125

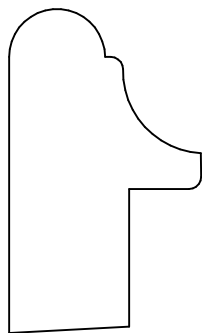

KL 15505
1.688 x 1.000

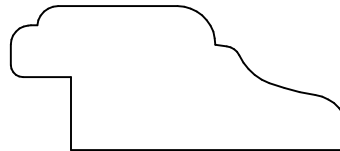

KL 15507
.750 x 1.750

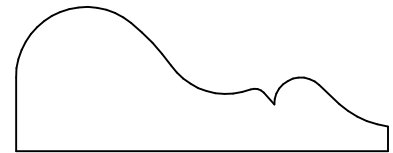

KL 15508
.750 x 1.937

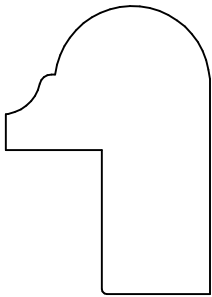

KL 15509
1.500 x 1.062

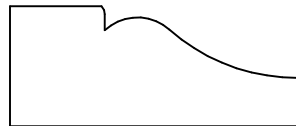

KL 15513
.625 x 1.500

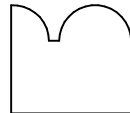

KL 15510
.562 x .625



KL 15511
.625 x .781

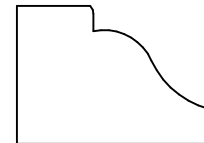

KL 15512
.718 x 1.000



KL 15565
.312 x .500

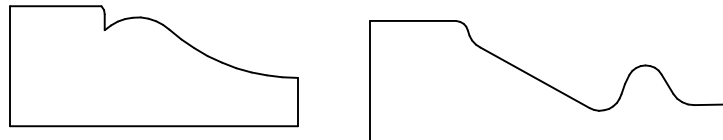

KL 15514
.625 x 1.875

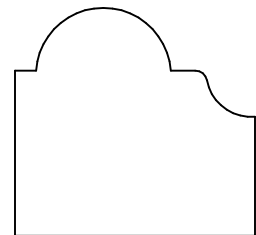

KL 15515
1.187 x 1.250



KL 15516
1.000 x 1.687



KL 15517
.625 x 2.000

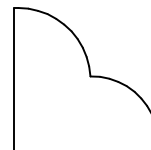

KL 15518
.750 x .750

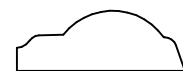

KL 15520
.312 x .875

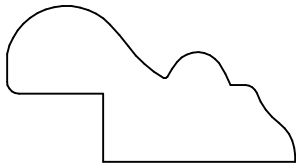

KL 15519
.812 x 1.500

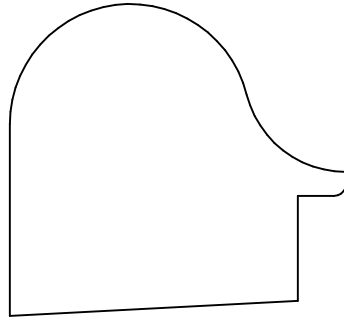

KL 15521
1.625 x 1.750

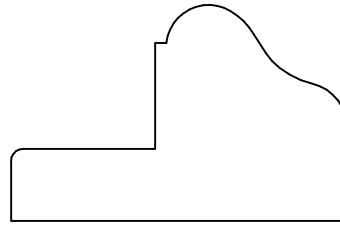

KL 15522
1.094 x 1.750



KL 15523
.406 x .812

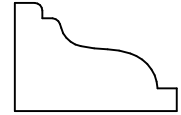

KL 15526
.563 x .843

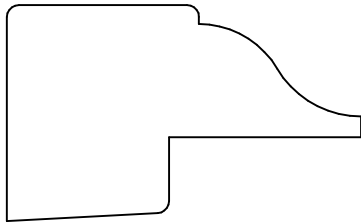

KL 15524
1.125 x 1.844

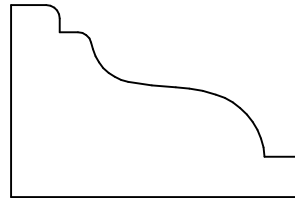

KL 15525
1.000 x 1.500

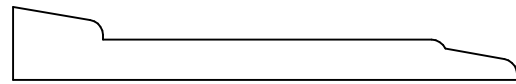

KL 15528
.380 x 2.625

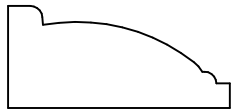

KL 15536
.531 x 1.156

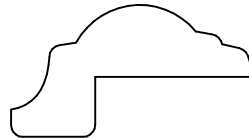

KL 15530
.687 x 1.250



KL 15531
.625 x 1.125



KL 15532
.407 x .750

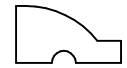

KL 15558
.296 x .546

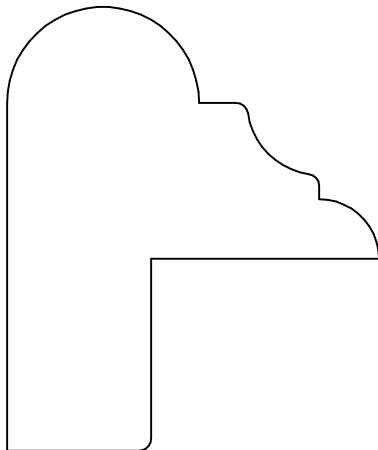

KL 15533
2.312 x 1.937

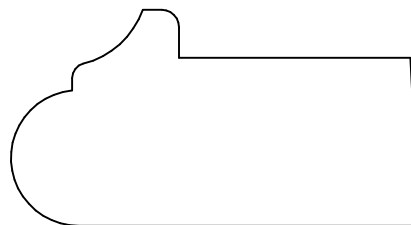

KL 15534
1.125 x 2.125

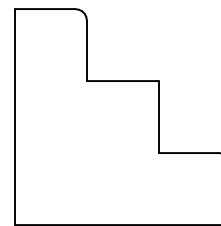

KL 15535
1.125 x 1.125



KL 15540
.391 x .687



KL 15549
.250 x .781



KL 15538
.625 x 1.250

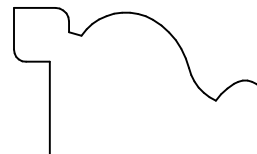

KL 15542
.781 x 1.312



KL 15544
.406 x .843



KL 15581
.312 x .968



KL 15553
.500 x 1.250

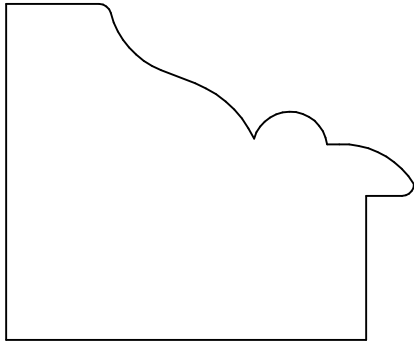

KL 15541
1.750 x 2.125

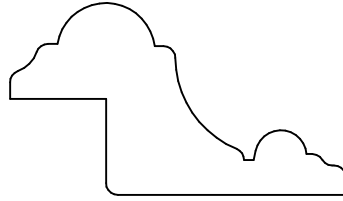

KL 15543
1.000 x 1.750

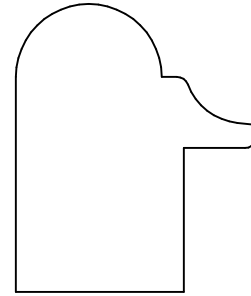

KL 15546
1.500 x 1.250



KL 15564
.434 x .750

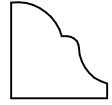

KL 15569
.500 x .500

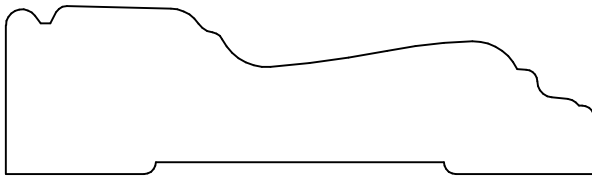

KL 15545
.875 x 3.062

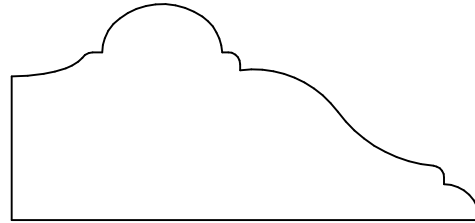

KL 15547
1.125 x 2.437

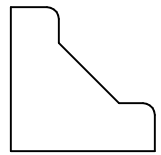

KL 15590
.750 x .750

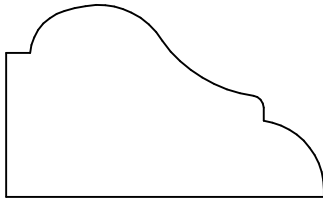

KL 15548
1.000 x 1.656

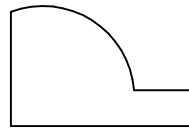

KL 15550
.625 x .937

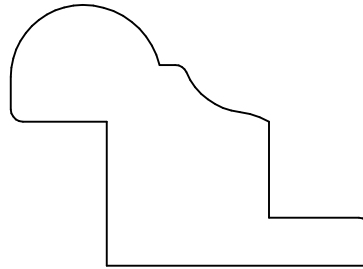

KL 15551
1.358 x 1.875

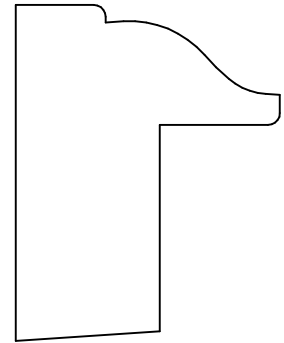

KL 15552
1.750 x 1.375

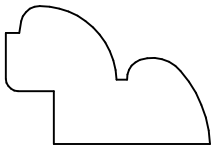

KL 15555
.718 x 1.062

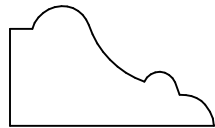

KL 15557
.625 x 1.062

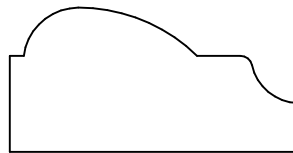

KL 15559
.750 x 1.500

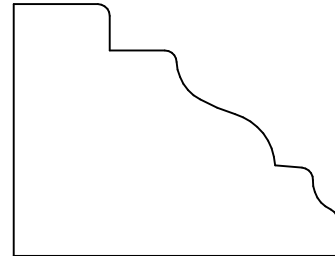

KL 15566
1.312 x 1.687

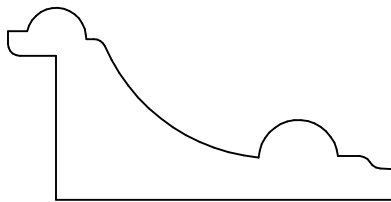

KL 15562
1.000 x 2.000

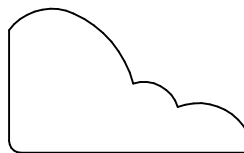

KL 15567
.750 x 1.250



KL 16508
.219 x .531

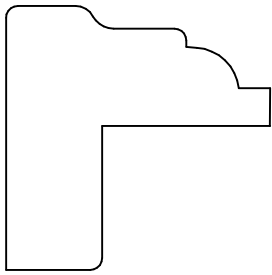

KL 15568
1.375 x 1.375

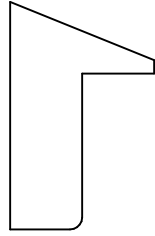

KL 15570
1.185 x .750

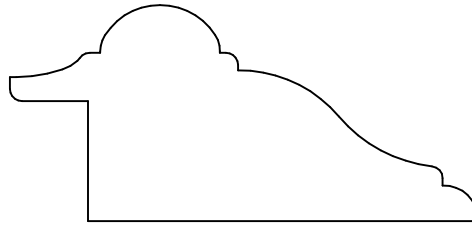

KL 15571
1.125 x 2.438

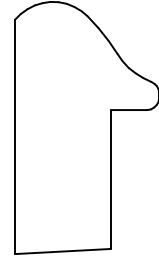

KL 15573
1.312 x .750

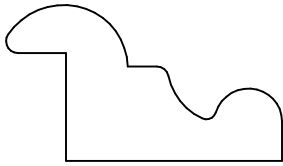

KL 15572
.812 x 1.437

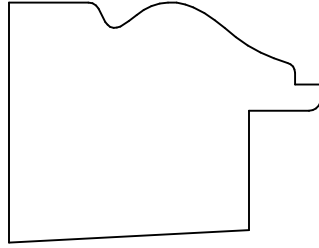

KL 15574
1.250 x 1.625

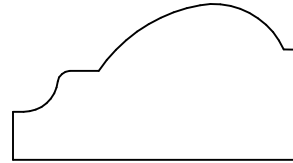

KL 15575
.812 x 1.500

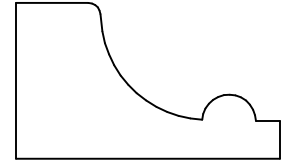

KL 15577
.812 x 1.375



KL 15576
.484 x 1.562

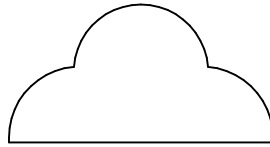

KL 15578
.718 x 1.375

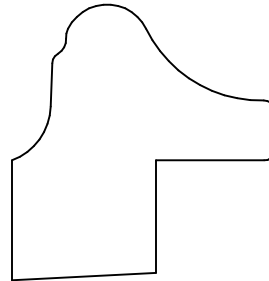

KL 15579
1.437 x 1.375

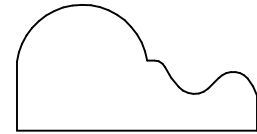

KL 15583
.656 x 1.250

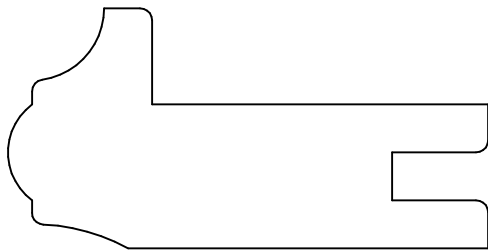

KL 15584
1.250 x 2.500

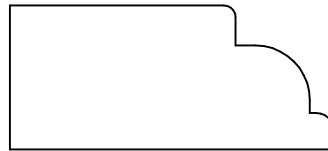

KL 15586
.750 x 1.687

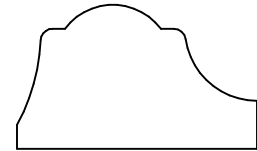

KL 15585
.750 x 1.250

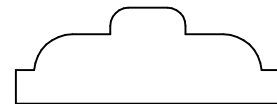

KL 15587
.500 x 1.375

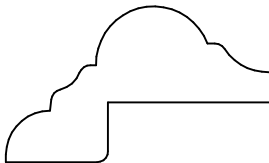

KL 15589
.812 x 1.375

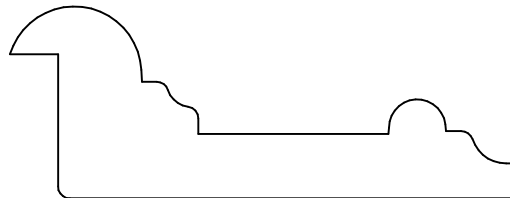

KL 15594
1.000 x 2.625



KL 15597
.750 x 1.375

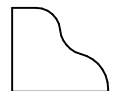

KL 16501
.438 x .500

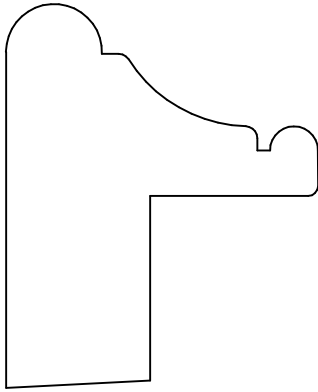

KL 15592
2.000 x 1.625

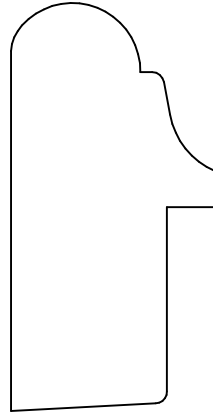

KL 15593
2.125 x 1.062

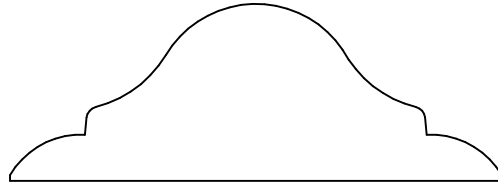

KL 15595
.921 x 2.562

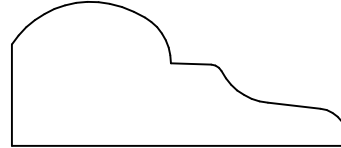

KL 15598
.750 x 1.750

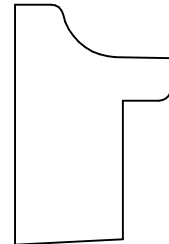

KL 15599
1.250 x .812

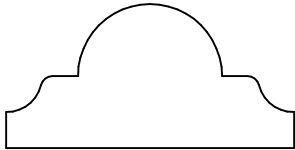

KL 16500
.750 x 1.500

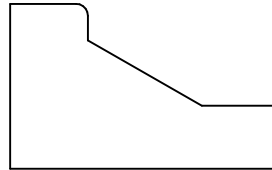

KL 16502
.859 x 1.375

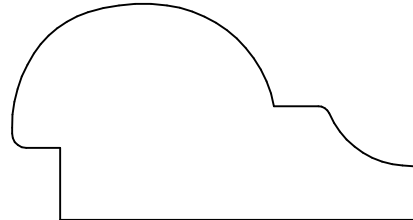

KL 16504
1.125 x 2.125



KL 16509
.520 x .740

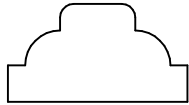

KL 16505
.510 x .935

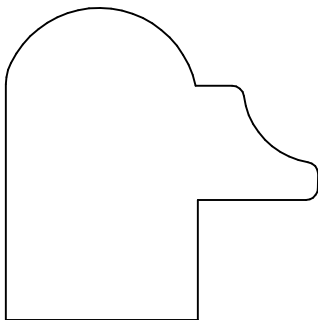

KL 16506
1.625 x 1.625

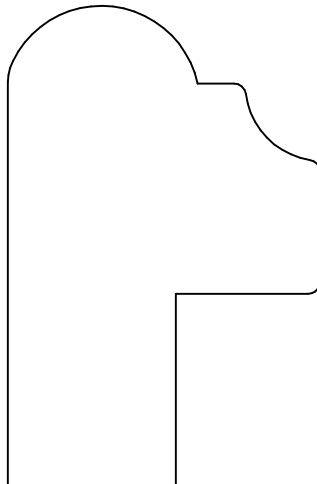

KL 16507
2.500 x 1.625

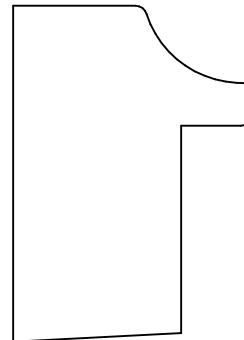

KL 16510
1.750 x 1.250

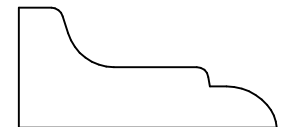

KL 16513
.625 x 1.343



KL 16517
.438 x .562

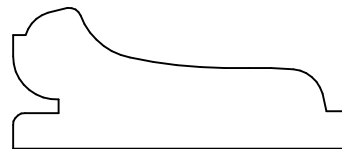

KL 16512
.734 x 1.750



KL 16516
.641 x .750

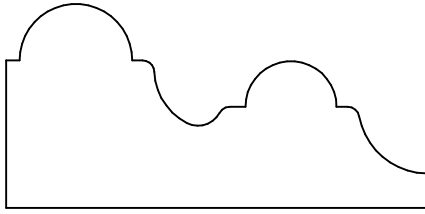

KL 16511
1.062 x 2.187

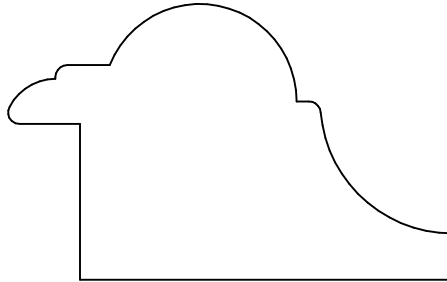

KL 16514
1.437 x 2.312

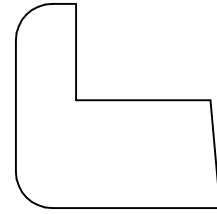

KL 16518
1.063 x 1.063

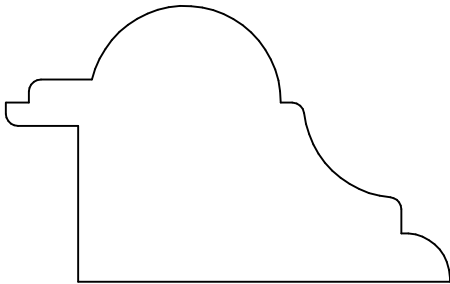

KL 16515
1.437 x 2.312

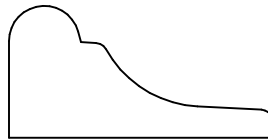

KL 16519
.687 x 1.375



KL 16585
.312 x .406

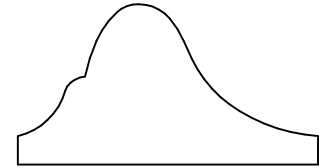

KL 16520
.835 x 1.562

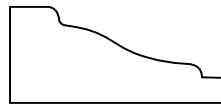

KL 16521
.500 x 1.125

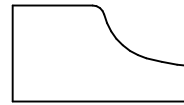

KL 16523
.500 x .938



KL 16525
.250 x .625

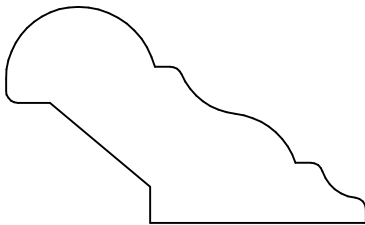

KL 16524
1.125 x 1.875

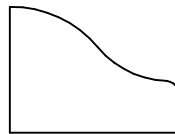

KL 16527
.656 x .875



KL 16528
.375 x 1.500



KL 16529
.406 x .875

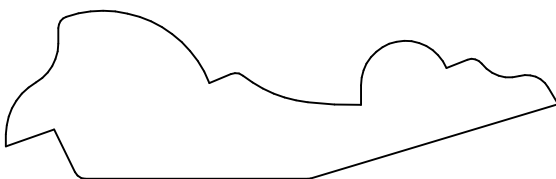

KL 16532
.875 x 2.875



KL 16530
.563 x .937



KL 16531
.500 x .687

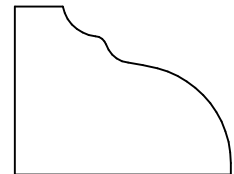

KL 16536
.875 x 1.125

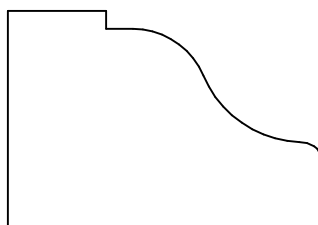

KL 16534
1.125 x 1.625

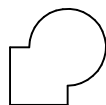

KL 16578
.500 x .500

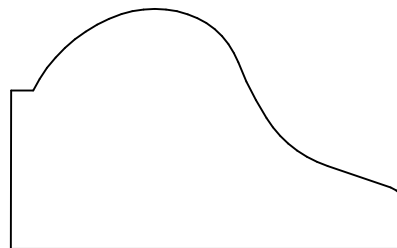

KL 16533
1.250 x 2.062

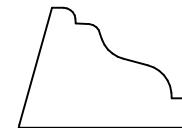

KL 16538
.625 x .875



KL 16580
.438 x .937

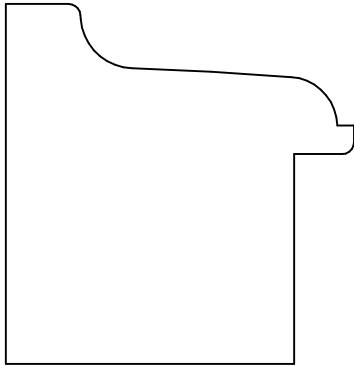

KL 16535
1.875 x 1.812

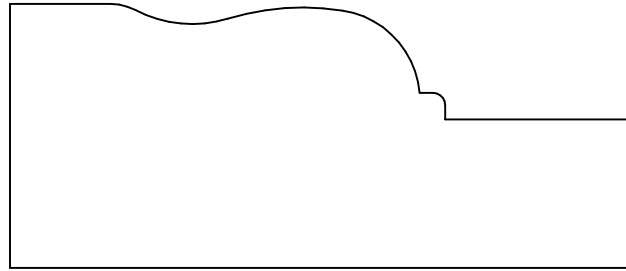

KL 16537
1.375 x 3.250

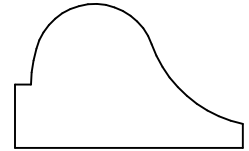

KL 16542
.750 x 1.187

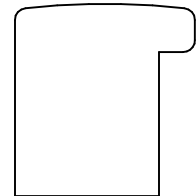

KL 16544
1.000 x .937



KL 16545
.312 x .812

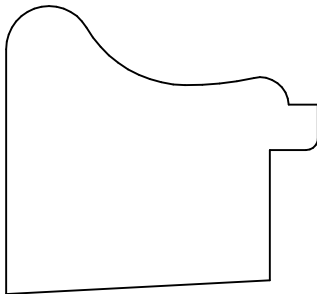

KL 16539
1.500 x 1.625

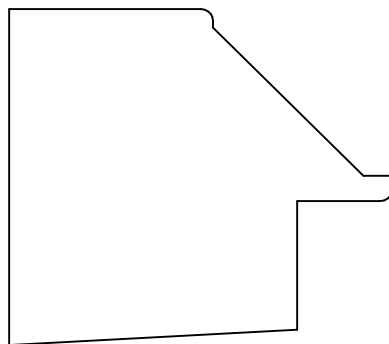

KL 16540
1.750 x 2.000

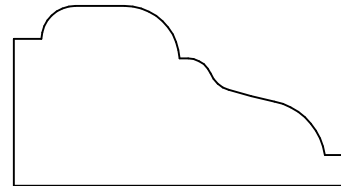

KL 16546
.937 x 1.750

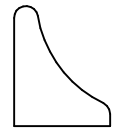

KL 16586
.625 x .500

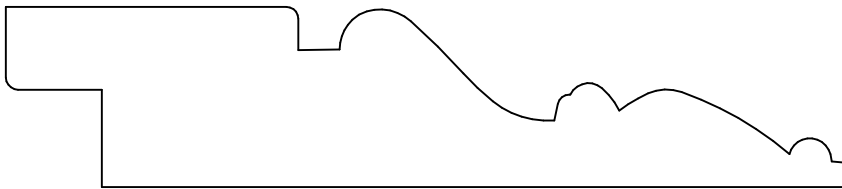

KL 16549
.937 x 4.375

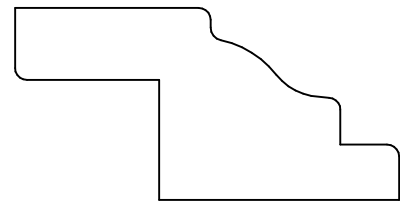

KL 16550
1.000 x 2.000

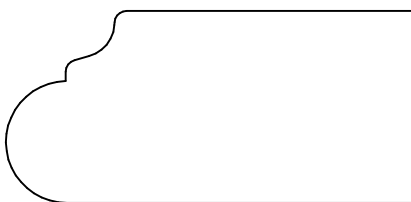

KL 16551
1.000 x 2.125

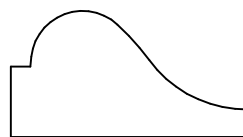

KL 16552
.656 x 1.234



KL 16553
.500 x 1.125

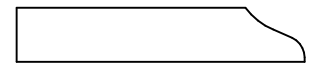

KL 16554
.281 x 1.500



KL 16574
.312 x 1.250



KL 16555
.531 x .875

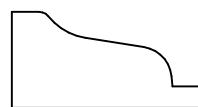

KL 16556
.500 x 1.000



KL 16558
.594 x .750

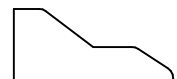

KL 17501
.375 x .830

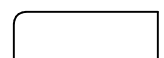

KL 17504
.250 x .750

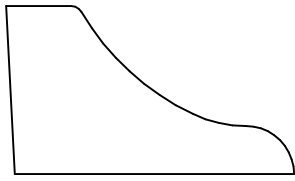

KL 16557
.875 x 1.500

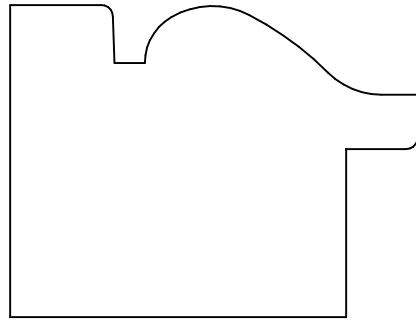

KL 16559
1.625 x 2.125

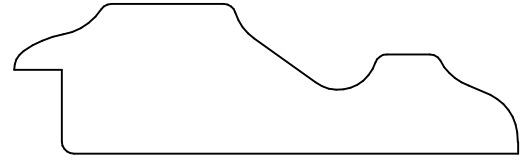

KL 16560
.780 x 2.625



KL 16561
.562 x 1.000

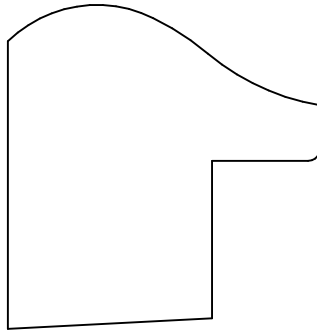

KL 16562
1.687 x 1.625

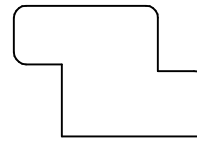

KL 16565
.680 x 1.000

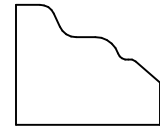

KL 16568
.625 x .750



KL 16592
.500 x 1.000

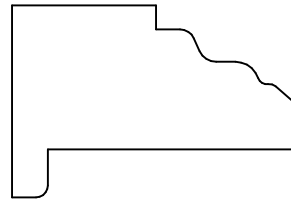

KL 16567
1.000 x 1.500

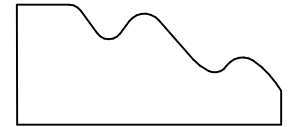

KL 16569
.625 x 1.375

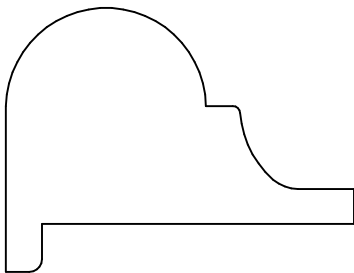

KL 16570
1.375 x 1.812

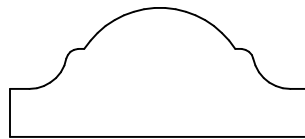

KL 16571
.672 x 1.562

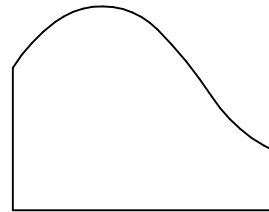

KL 16572
1.062 x 1.375

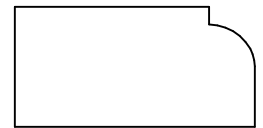

KL 16575
.625 x 1.250

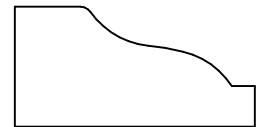

KL 16577
.625 x 1.250

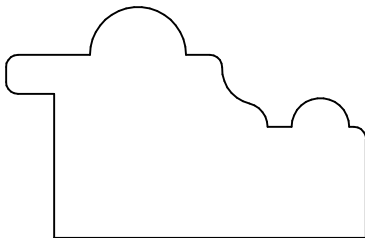

KL 16573
1.203 x 1.875

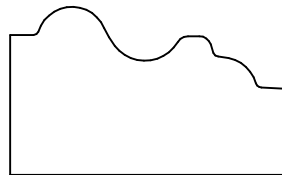

KL 16576
.875 x 1.437



KL 16581
.531 x 1.875



KL 17519
.437 x .675

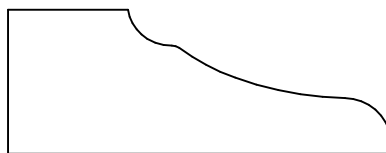

KL 16583
.750 x 2.000

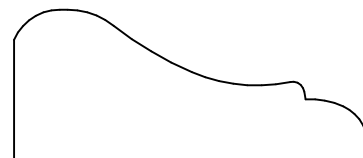

KL 16584
.781 x 1.843

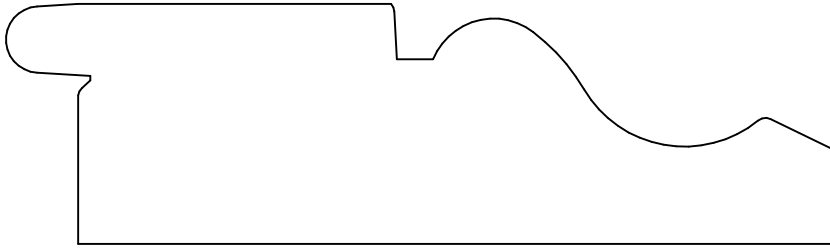

KL 16579
1.250 x 4.312

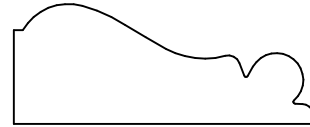

KL 16588
.625 x 1.562

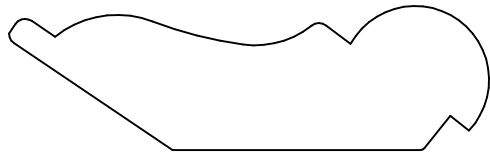

KL 16589
.750 x 2.500

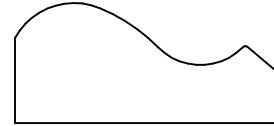

KL 16590
.625 x 1.375



KL 17568
.375 x .500



KL 16595
.375 x 1.125

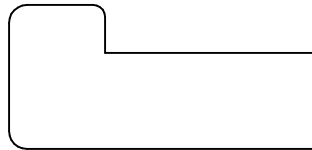

KL 16593
1.625 x .750

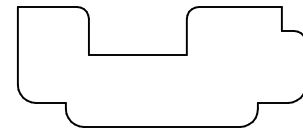

KL 16594
.625 x 1.500

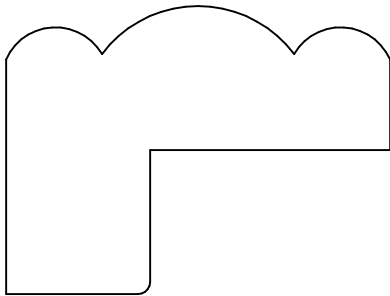

KL 16596
1.500 x 2.000

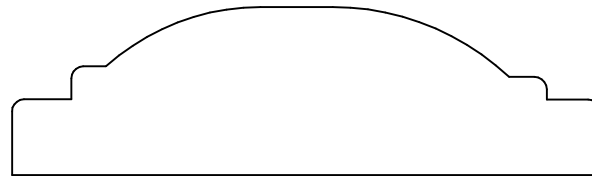

KL 16597
.875 x 3.062

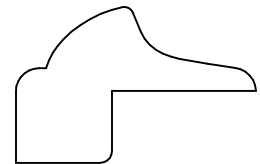

KL 16598
.812 x 1.250

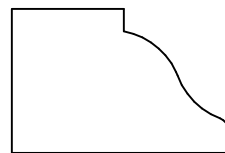

KL 16599
.750 x 1.125

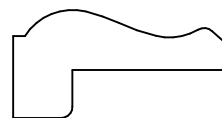

KL 17500
.562 x 1.125

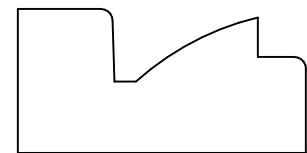

KL 17502
.750 x 1.500

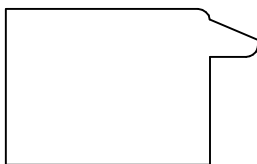

KL 17503
.812 x 1.312

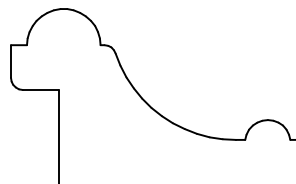

KL 17505
.921 x 1.500



KL 17507
.750 x 1.750

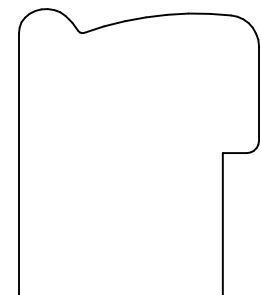

KL 17509
1.500 x 1.250

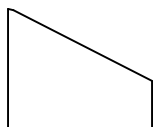

KL 17514
.625 x .750

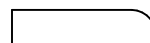

KL 17525
.187 x .750

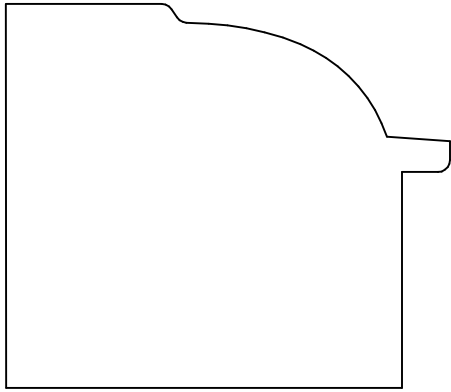

KL 17508
2.000 x 2.062

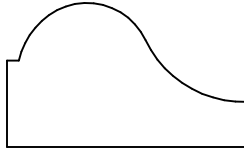

KL 17510
.750 x 1.250

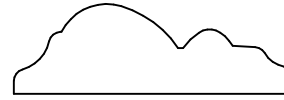

KL 17511
.468 x 1.437

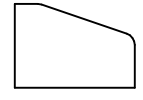

KL 17554
.437 x .625

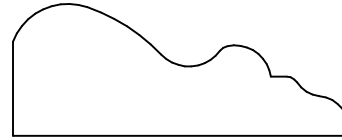

KL 17512
.687 x 1.750



KL 17565
.375 x .625

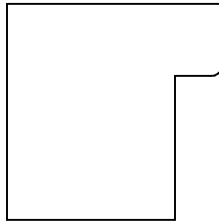

KL 17513
1.125 x 1.125

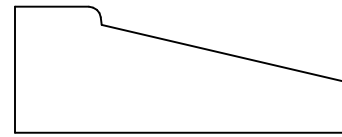

KL 17517
.656 x 1.750



KL 17523
.468 x .812

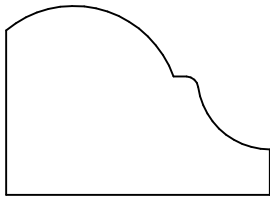

KL 17515
.984 x 1.375

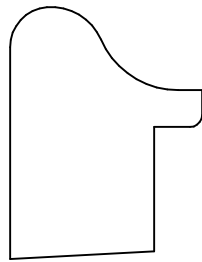

KL 17516
1.312 x 1.000

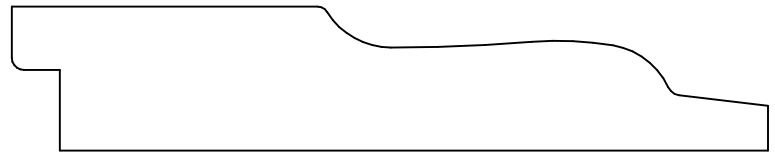

KL 17520
.750 x 3.937



KL 17518
.531 x .875

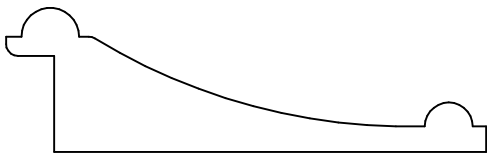

KL 17521
.750 x 2.500

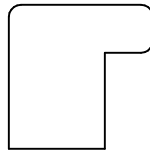

KL 17524
.750 x .750

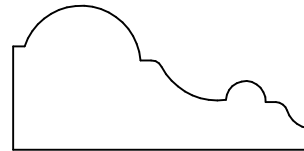

KL 17526
.750 x 1.563

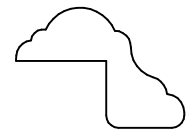

KL 17538
.625 x .875

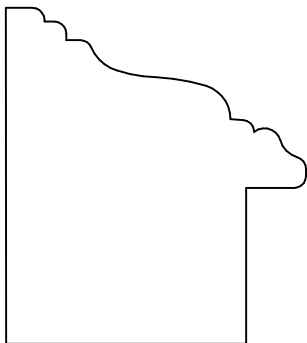

KL 17527
1.750 x 1.562

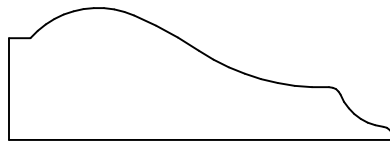

KL 17528
.688 x 2.000



KL 17529
.500 x 1.250

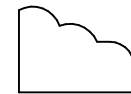

KL 17573
.446 x .600



KL 17576
.375 x .750



KL 19510
.250 x .750

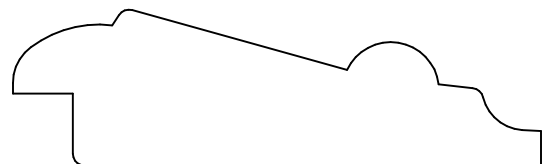

KL 17531
.812 x 2.750

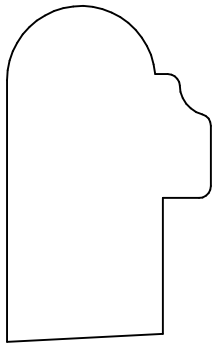

KL 17530
1.750 x 1.062

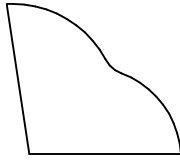

KL 17532
.781 x .906

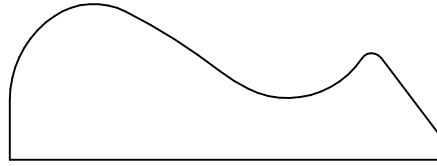

KL 17533
.812 x 2.250

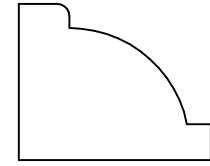

KL 17537
.812 x 1.000

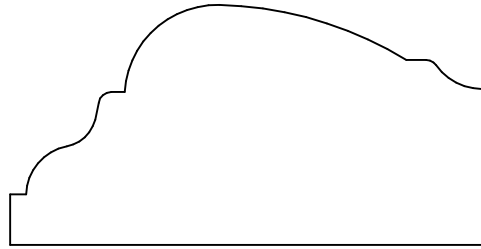

KL 17536
1.250 x 2.500

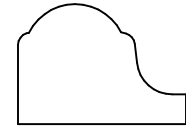

KL 17540
.625 x .875

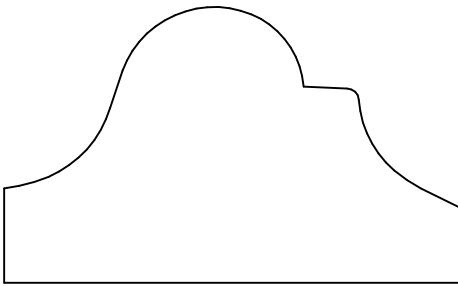

KL 17535
1.437 x 2.375

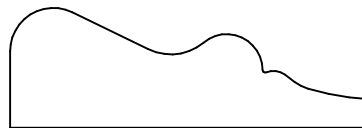

KL 17539
.625 x 1.875

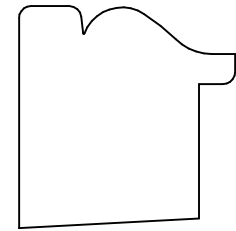

KL 17541
1.156 x 1.125

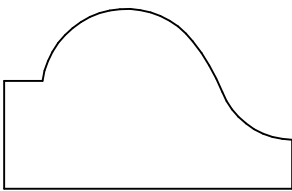

KL17543
.938 x 1.500

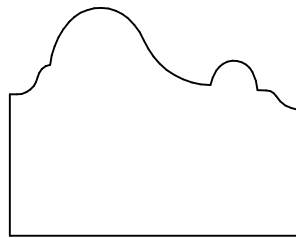

KL 17544
1.187 x 1.500

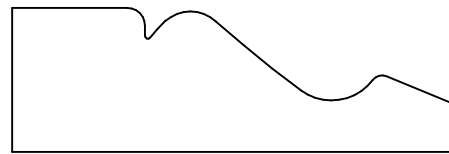

KL 17545
.750 x 2.312

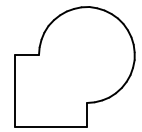

KL17579
.625 x .625

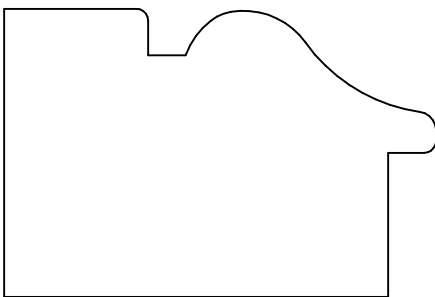

KL 17546
1.500 x 2.250

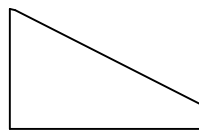

KL 17547
.625 x 1.000

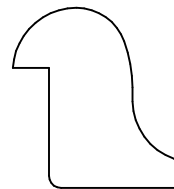

KL 17548
.938 x .875

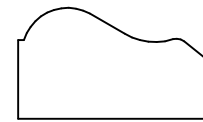

KL 17549
.578 x 1.000



KL 19520
.406 x .500

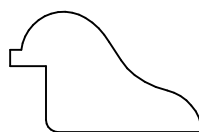

KL 17550
.625 x 1.000



KL 17552
.687 x 1.125

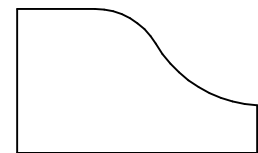

KL 17555
.750 x 1.250

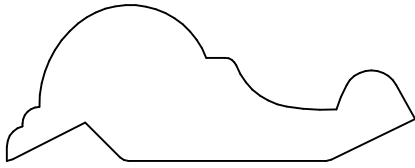

KL 17556
.812 x 2.125



KL 17558
.312 x 1.000

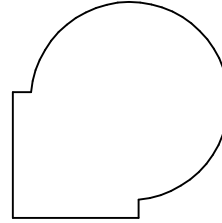

KL 17561
1.125 x 1.125

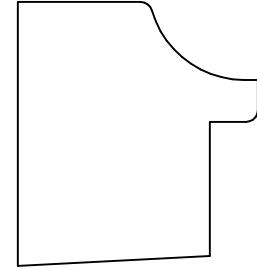

KL 17562
1.375 x 1.250

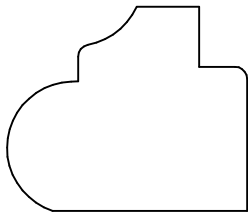

KL 17563
1.062 x 1.250

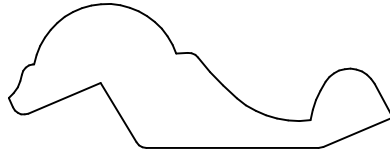

KL 17564
.750 x 2.000

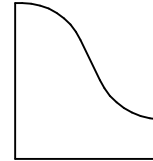

KL 17569
.812 x .750

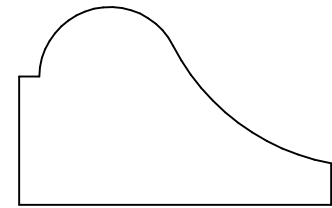

KL 17572
1.031 x 1.625

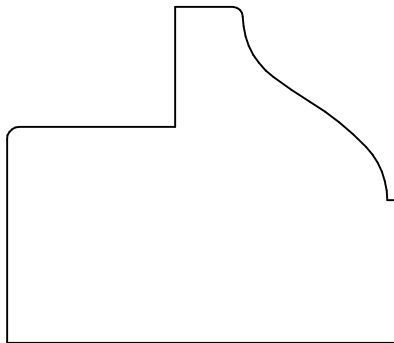

KL 17570
2.031 x 1.750

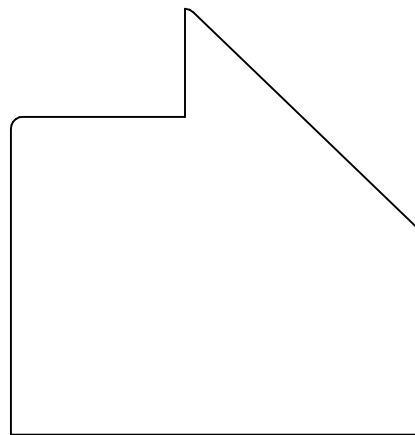

KL 17571
2.156 x 2.218

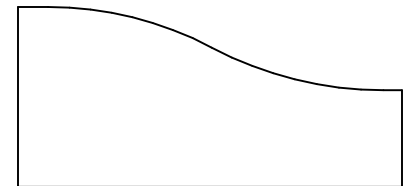

KL 17575
.938 x 2.000

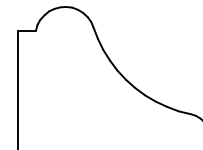

KL 17578
.750 x 1.000

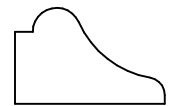

KL 17582
.500 x .781

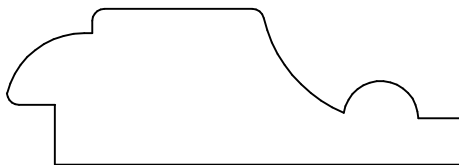

KL 17574
.812 x 2.375

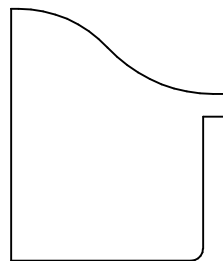

KL 17577
1.312 x 1.125



KL 17580
.750 x 1.000

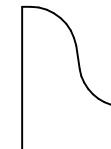

KL 17586
.500 x .750



KL 19547
.375 x .500

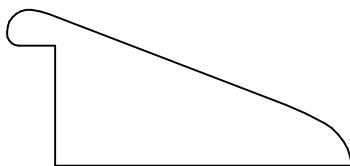

KL 17587
.812 x 1.796



KL 17591
.562 x .812



KL 19504
.438 x .812

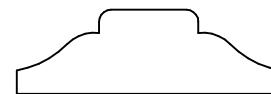

KL 19505
.437 x 1.375



KL 19529
.469 x .812

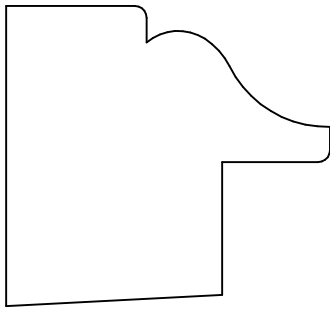

KL 17581
1.563 x 1.687

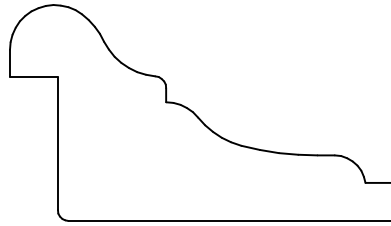

KL 17584
1.125 x 2.000

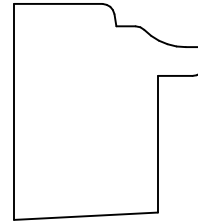

KL 17585
1.125 x 1.000

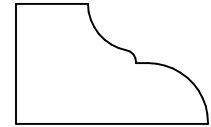

KL 17589
.625 x 1.000

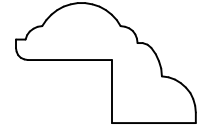

KL 17592
.625 x .937

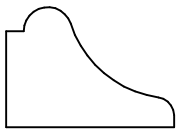

KL 17593
.625 x .875

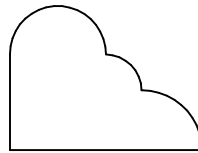

KL 17590
.750 x 1.000

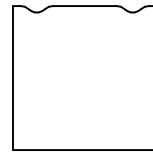

KL 17594
.750 x .750

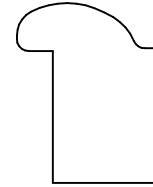

KL 17597
.938 x .750

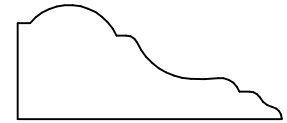

KL 17598
.594 x 1.375

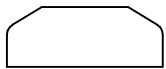

KL 19537
.312 x .812

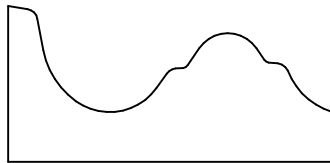

KL 17596
.813 x 1.687

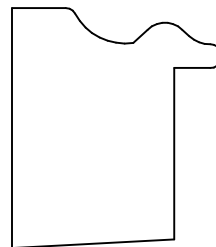

KL 17599
1.250 x 1.094

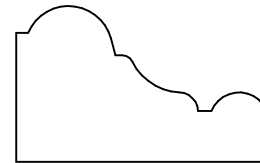

KL 19500
.812 x 1.312

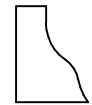

KL 19572
.500 x .375

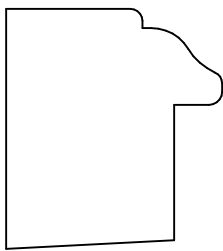

KL 19502
1.250 x 1.125

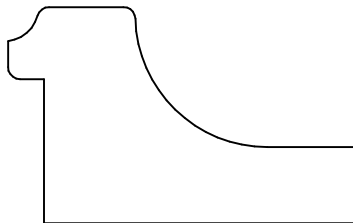

KL 19503
1.125 x 1.812



KL 19506
.438 x 1.813

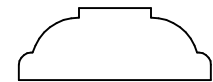

KL 19526
.375 x 1.000

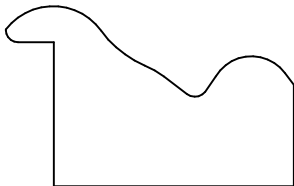

KL 19512
.938 x 1.500

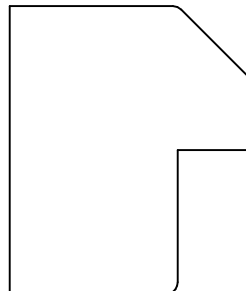

KL 19515
1.500 x 1.250

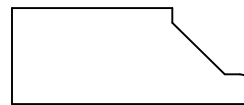

KL 19511
.500 x 1.250

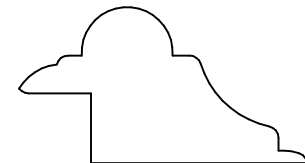

KL 19514
.813 x 1.500

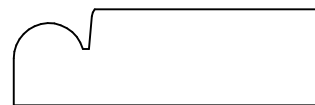

KL 19516
.500 x 1.625



KL 19517
.563 x .875

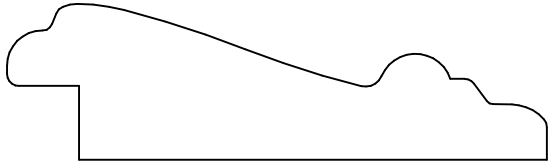

KL 19518
.812 x 2.812

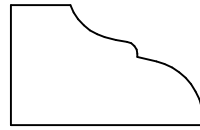

KL 19521
.625 x 1.000

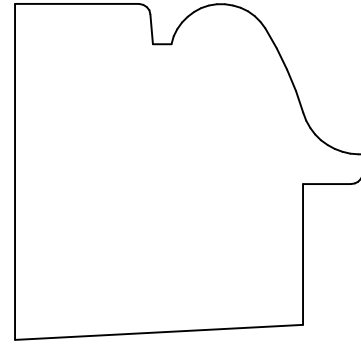

KL 19523
1.750 x 1.812

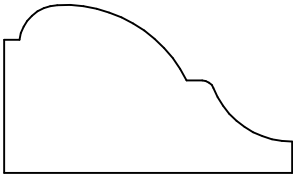

KL 19524
.875 x 1.500

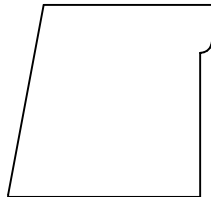

KL 19527
1.000 x 1.063

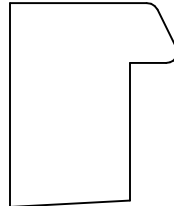

KL 19530
1.062 x .875

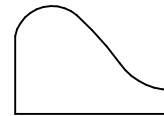

KL 19532
.562 x .812



KL 19540
.375 x .750

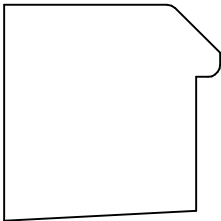

KL 19528
1.125 x 1.125

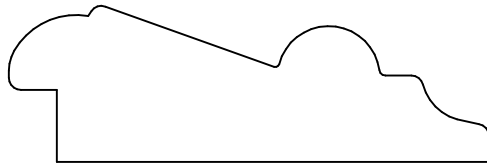

KL 19533
.812 x 2.500

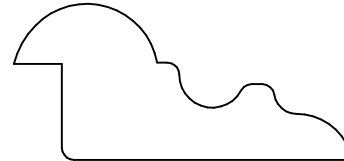

KL 19534
.812 x 1.750

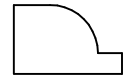

KL 19576
.359 x .562

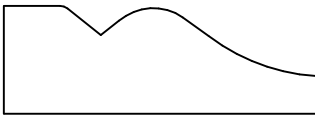

KL 19535
.562 x 1.625

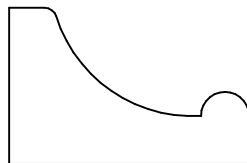

KL 19536
.813 x 1.250

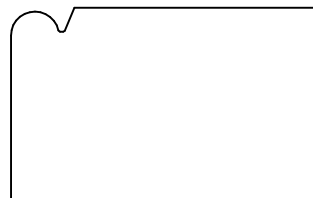

KL 19538
1.000 x 1.625

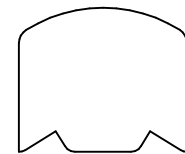

KL 19539
.750 x .875

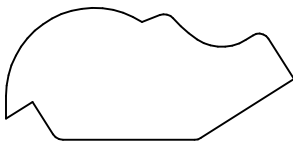

KL 19541
.688 x 1.500



KL 19543
.625 x .938

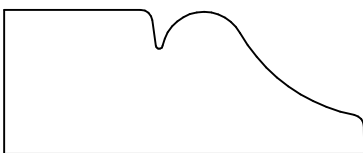

KL 19542
.750 x 1.875

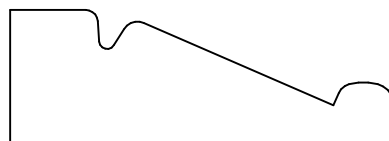

KL 19544
.688 x 2.000

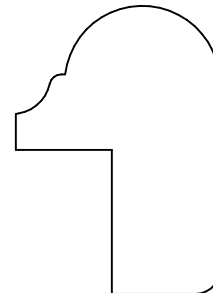

KL 19545
1.500 x 1.062

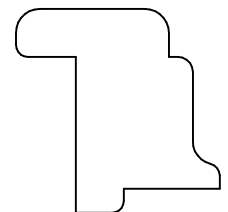

KL 19548
1.062 x 1.062



KL 19550
.250 x .750

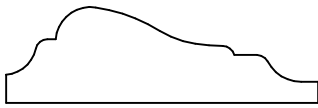

KL 19546
.500 x 1.625

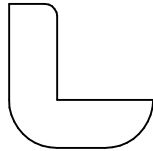

KL 19549
.750 x .750

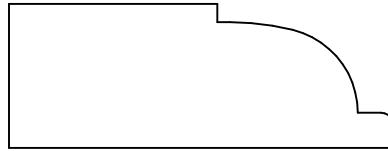

KL 19551
.750 x 2.000

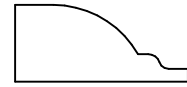

KL 19562
.400 x .900

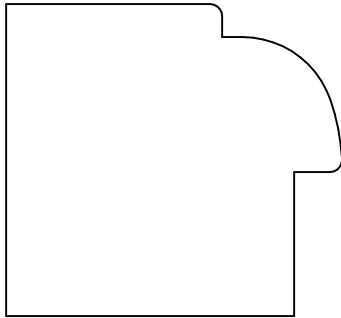

KL 19552
1.625 x 1.750

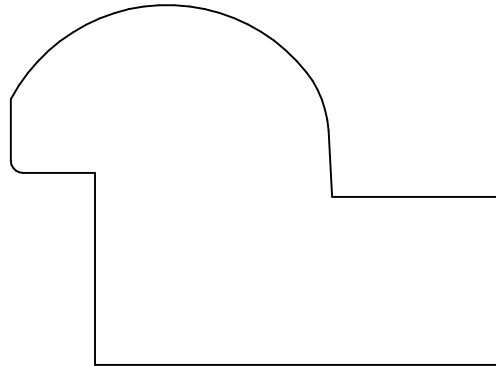

KL 19553
1.875 x 2.562

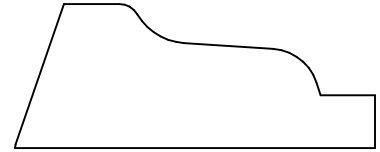

KL 19554
.750 x 1.875



KL 19558
.625 x 1.750

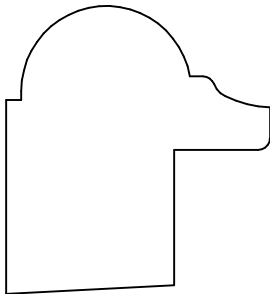

KL 19557
1.500 x 1.375

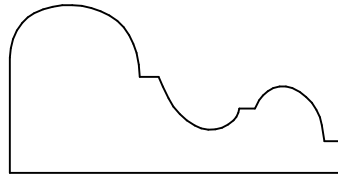

KL 19560
.875 x 1.725

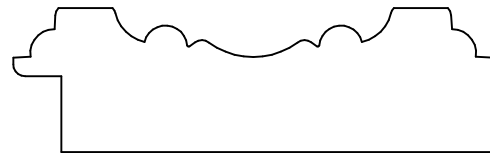

KL 19563
.750 x 2.500



KL 20528
.250 x .375

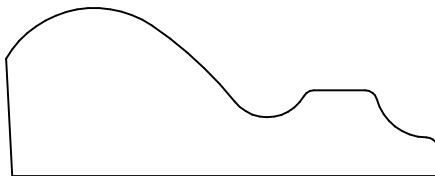

KL 19564
.875 x 2.250

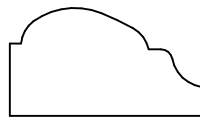

KL 19565
.562 x 1.000

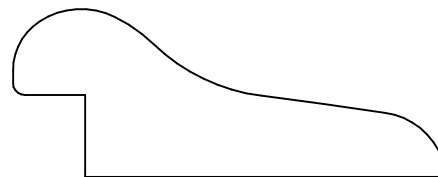

KL 19566
.875 x 2.250

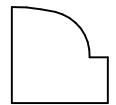

KL 19593
.500 x .500



KL 19567
.625 x 2.812

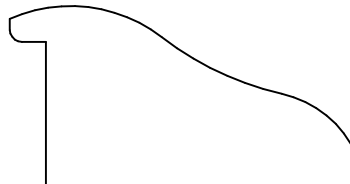

KL 19569
.937 x 1.797



KL 19570
.531 x 1.062

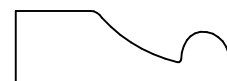

KL 20514
.375 x 1.109

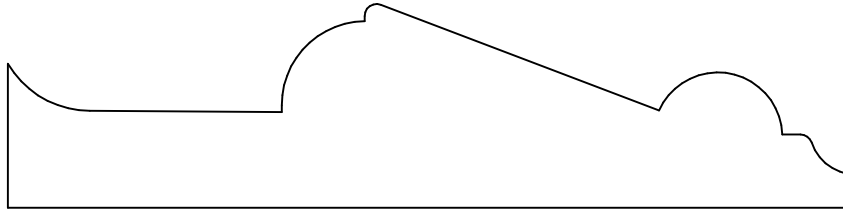

KL 19568
1.062 x 4.375

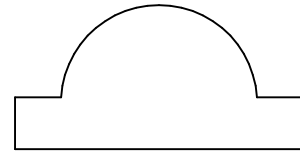

KL 19571
.750 x 1.500

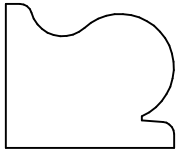

KL 19573
.750 x .875

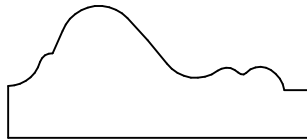

KL 19574
.687 x 1.562

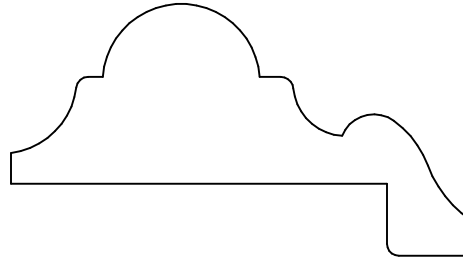

KL 19575
1.312 x 2.396

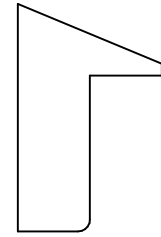

KL 19577
1.185 x .750

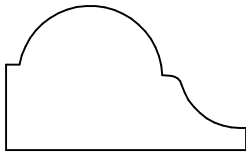

KL 19578
.750 x 1.250

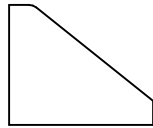

KL 19580
.625 x .750

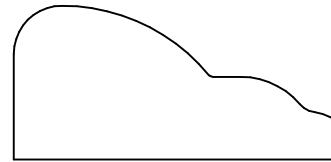

KL 19582
.800 x 1.700

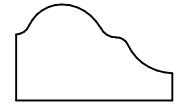

KL 19590
.500 x .813

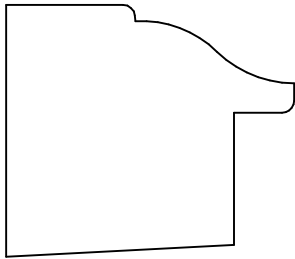

KL 19579
1.312 x 1.500

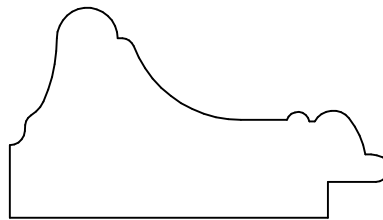

KL 19581
1.094 x 1.968

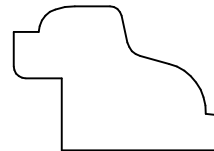

KL 19583
.750 x 1.093

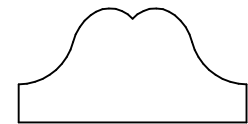

KL 19584
.594 x 1.187

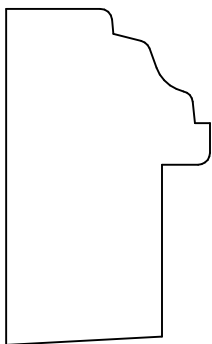

KL 19585
1.750 x 1.062

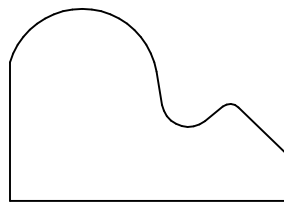

KL 19588
1.000 x 1.437

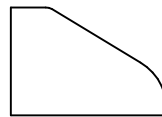

KL 19591
.562 x .812

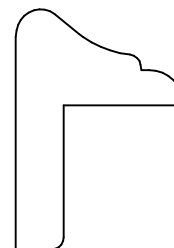

KL 19592
1.250 x .875

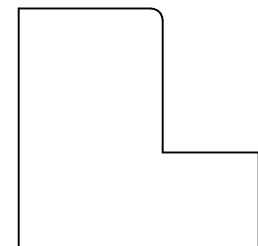

KL 19594
1.250 x 1.250



KL 20506
.438 x 1.125

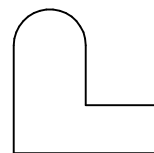

KL 20510
.750 x .750

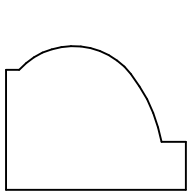

KL 19595
.750 x .938

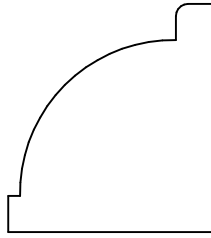

KL 19596
1.188 x 1.062

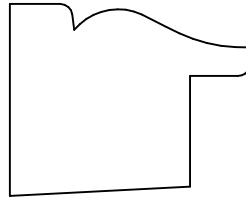

KL 19597
1.000 x 1.250

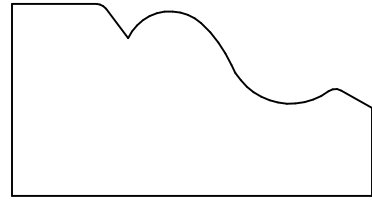

KL 19598
1.000 x 1.875

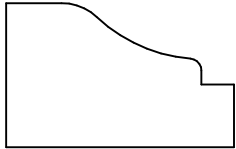

KL 19599
.750 x 1.187

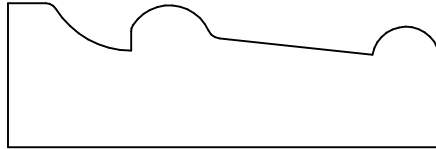

KL 20500
.750 x 2.250

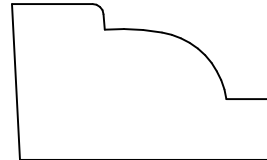

KL 20501
.812 x 1.375

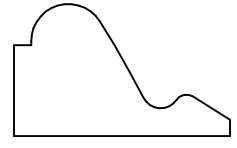

KL 20504
.688 x 1.125

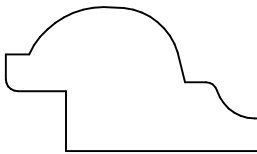

KL 20502
.750 x 1.313

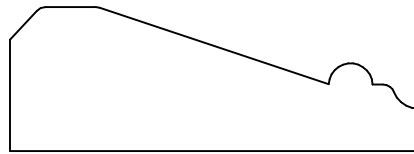

KL 20503
.750 x 2.125

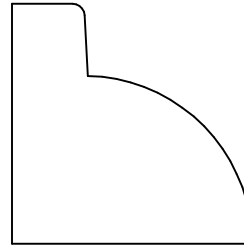

KL 20508
1.250 x 1.250

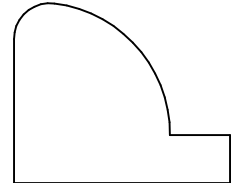

KL 20505
.938 x 1.125

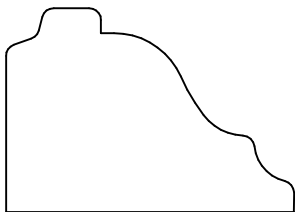

KL 20511
1.063 x 1.500

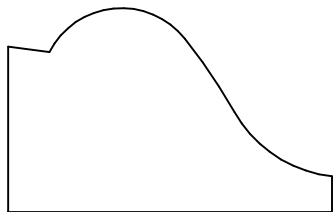

KL 20512
1.062 x 1.688

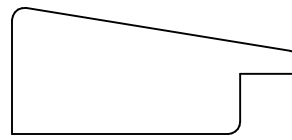

KL 20513
.656 x 1.500

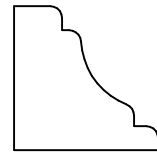

KL 20515
.750 x .750

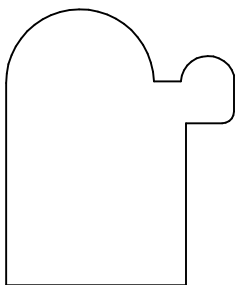

KL 20516
1.438 x 1.188

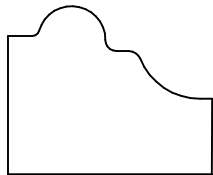

KL 20517
.875 x 1.062

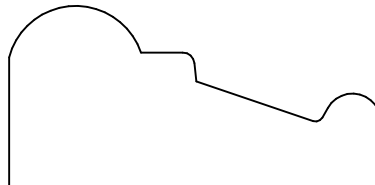

KL 20518
.937 x 1.938

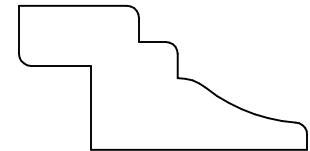

KL 20520
.750 x 1.500



KL 20525
.375 x .750



KL 20527
.500 x 1.062

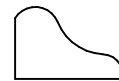

KL 20531
.375 x .562

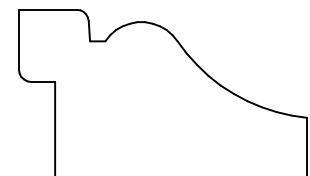

KL 20522
.875 x 1.500

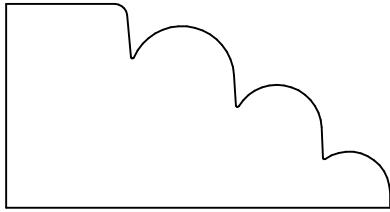

KL 20521
1.062 x 2.000

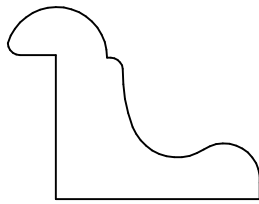

KL 20526
1.000 x 1.312

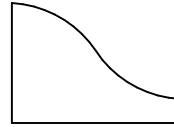

KL 20529
.625 x .875

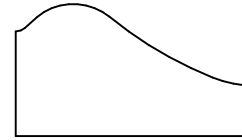

KL 20532
.688 x 1.187

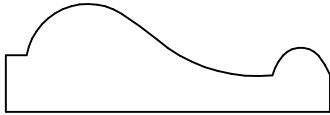

KL 20534
.562 x 1.687

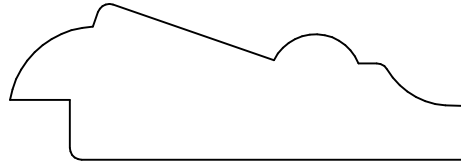

KL 20535
.812 x 2.375

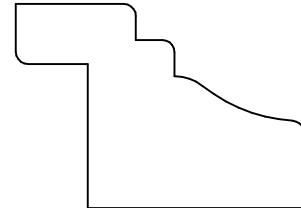

KL 20536
1.062 x 1.500

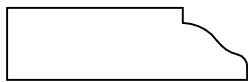

KL 20537
.375 x 1.250

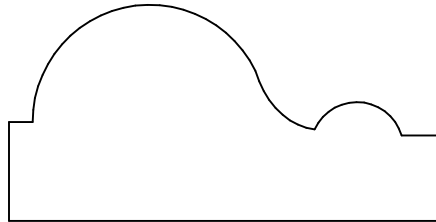

KL 20538
1.125 x 2.250

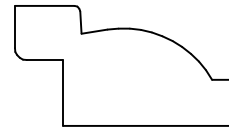

KL 20539
.625 x 1.156

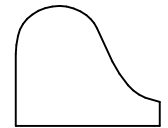

KL 20544
.625 x .750

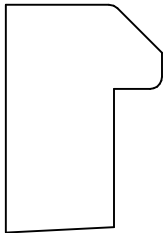

KL 20540
1.187 x .812

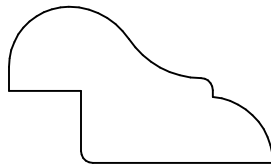

KL 20541
.813 x 1.375

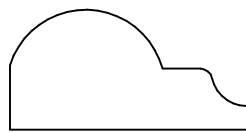

KL 20542
.625 x 1.250



KL 20543
.563 x 2.000



KL 20545
.469 x 1.250



KL 20551
.562 x .750



KL 20546
.750 x .938

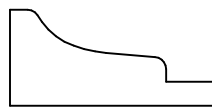

KL 20547
.500 x 1.063

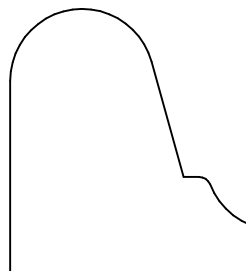

KL 20548
1.375 x 1.250

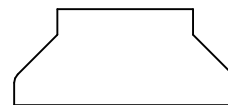

KL 20549
.500 x 1.157

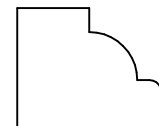

KL 20553
.625 x .750



KL 20550
.750 x 1.688

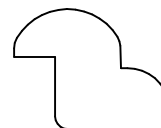

KL 20561
.625 x .812



KL 20562
.500 x .812

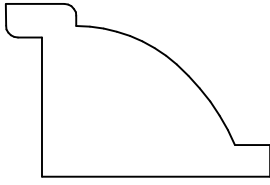

KL 20552
.900 x 1.375

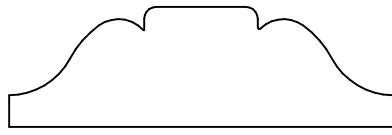

KL 20554
.625 x 2.000

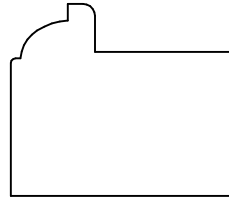

KL 20556
1.000 x 1.187

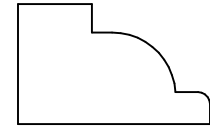

KL 20563
.625 x 1.000

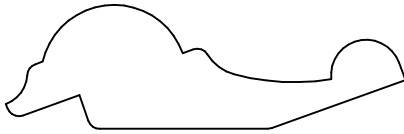

KL 20557
.646 x 2.080

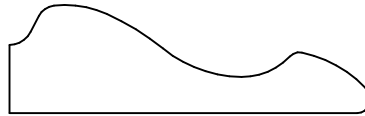

KL 20559
.563 x 1.875

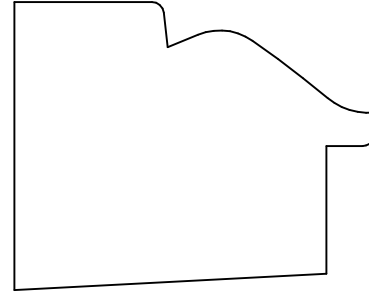

KL 20564
1.500 x 1.875

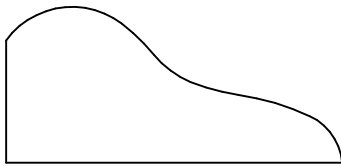

KL 20565
.812 x 1.750

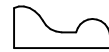

KL 21542
.218 x .500

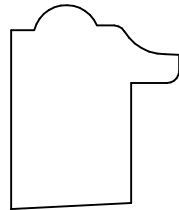

KL 20566
1.062 x .875

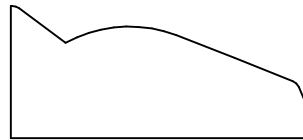

KL 20570
.688 x 1.562

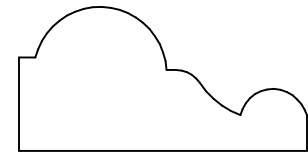

KL 20571
.750 x 1.500

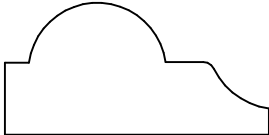

KL 20569
.688 x 1.375

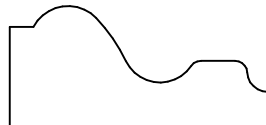

KL 20574
.625 x 1.343

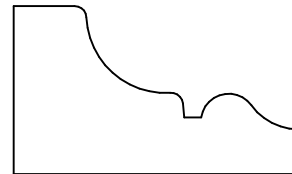

KL 20575
.875 x 1.500

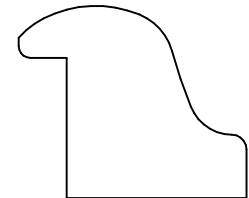

KL 20577
1.000 x 1.187



KL 20573
.781 x 1.718

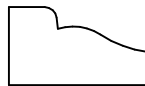

KL 20578
.406 x .718



KL 20579
.500 x .750

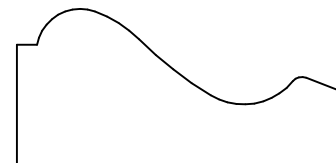

KL 20580
.812 x 1.688

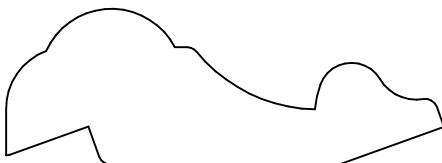

KL 20576
.812 x 2.281



KL 20581
.578 x .812



KL 20584
.500 x .593



KL 20597
.305 x .750

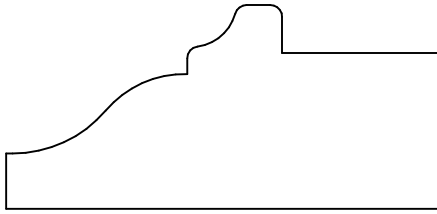

KL 20585
1.062 x 2.250

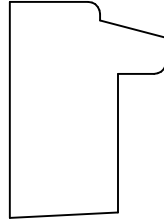

KL 20586
1.125 x .812

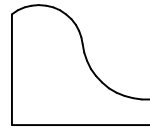

KL 20587
.625 x .750

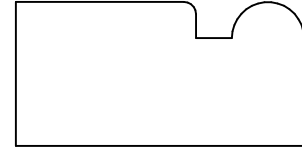

KL 20588
.750 x 1.500

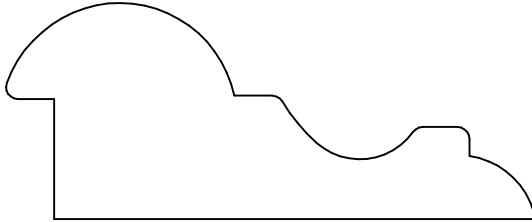

KL 20589
1.125 x 2.750

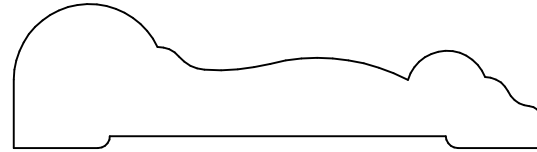

KL 20590
.750 x 2.750

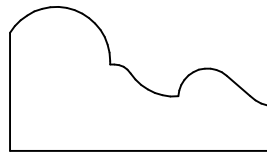

KL 20591
.750 x 1.375



KL 20592
.531 x 1.625

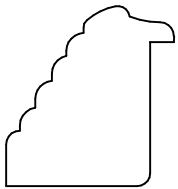

KL 20593
.938 x .875

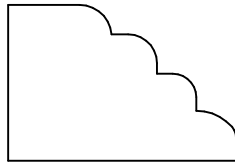

KL 20594
.812 x 1.188

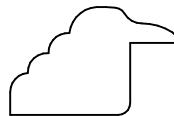

KL 20595
.562 x .875



KL 20598
.320 x .750

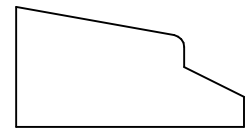

KL 21501
.625 x 1.188



KL 21509
.531 x .625

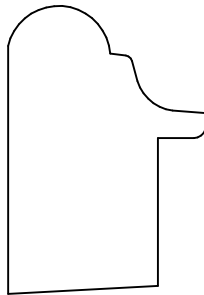

KL 20596
1.500 x 1.031

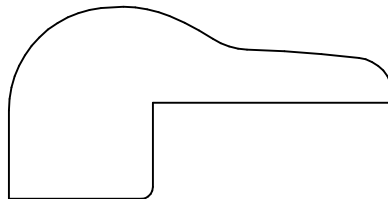

KL 20599
1.000 x 2.000

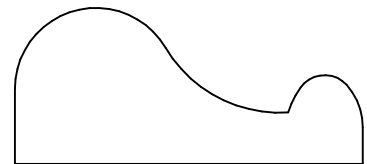

KL 21502
.812 x 1.812

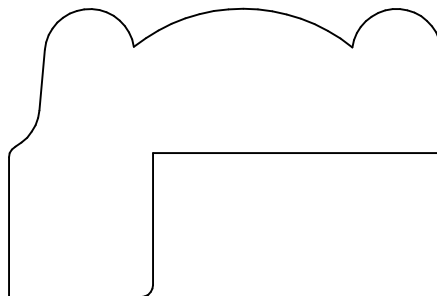

KL 21500
1.500 x 2.250

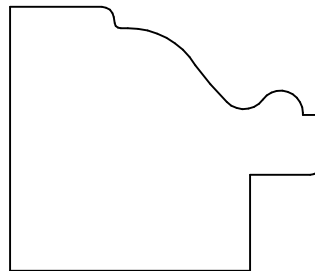

KL 21503
1.375 x 1.625

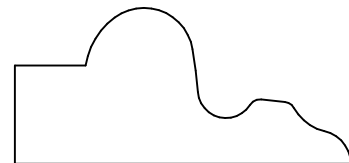

KL 21504
.812 x 1.750

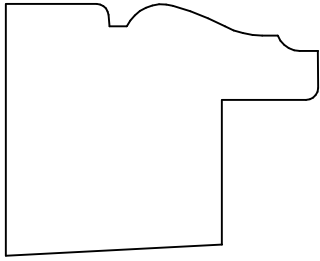

KL 21505
1.312 x 1.625



KL 21506
.625 x 2.375

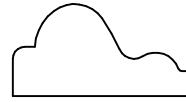

KL 21507
.480 x .937

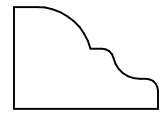

KL 21510
.531 x .750

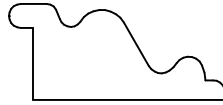

KL 21531
.500 x 1.125

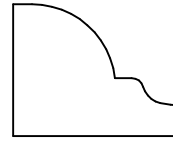

KL 21511
.688 x .875

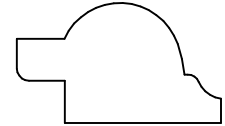

KL 21537
.625 x 1.062

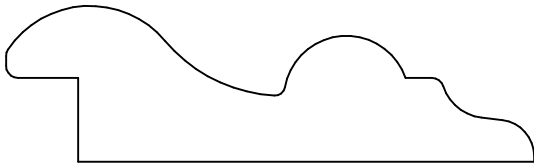

KL 21508
.812 x 2.750

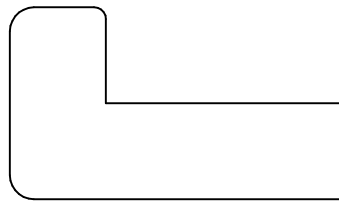

KL 21515
1.000 x 1.750

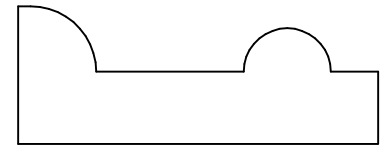

KL 21521
.718 x 1.875

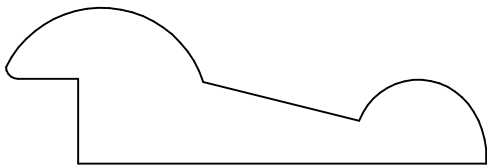

KL 21519
.812 x 2.500

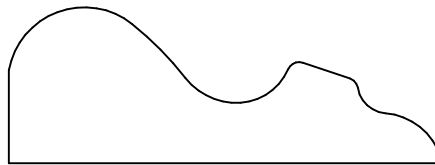

KL 21522
.812 x 2.250

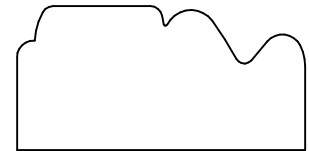

KL 21524
.750 x 1.500

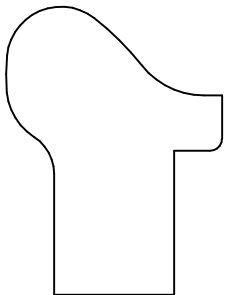

KL 21523
1.500 x 1.125

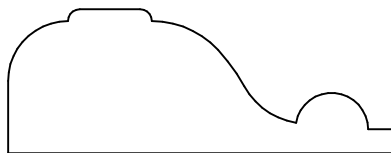

KL 21527
.750 x 2.000

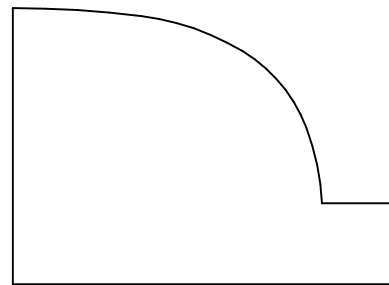

KL 21528
1.437 x 2.000

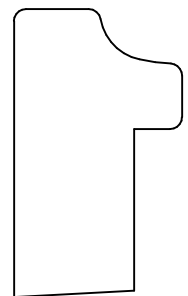

KL 21534
1.500 x .875

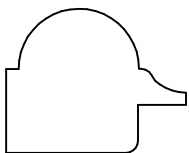

KL 21529
.750 x .938

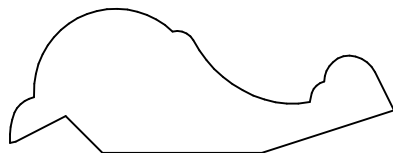

KL 21532
.750 x 2.000

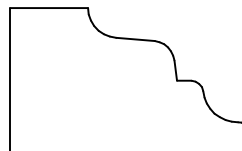

KL 21533
.750 x 1.250



KL 21538
.650 x 1.750

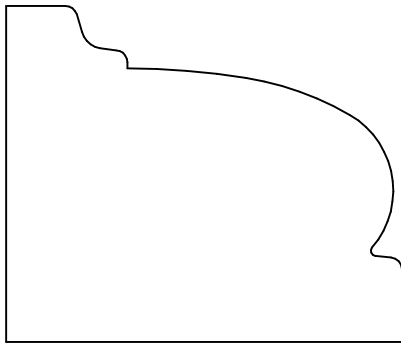

KL 21535
1.750 x 2.062

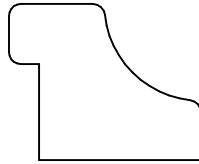

KL 21539
.813 x 1.000

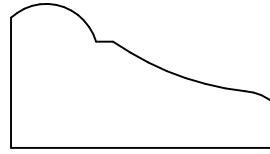

KL 21540
.750 x 1.375

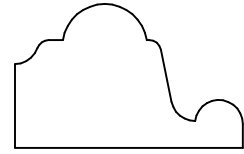

KL 21541
.750 x 1.187

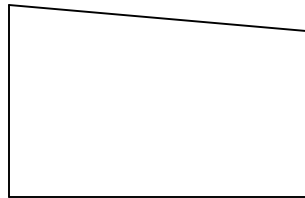

KL 21543
1.000 x 1.562

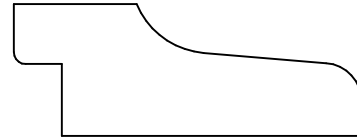

KL 21544
.688 x 1.812



KL 21559
.312 x .500

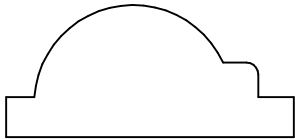

KL 21545
.688 x 1.500

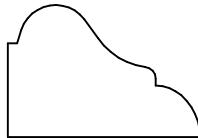

KL 21546
.687 x 1.000

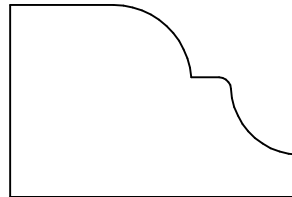

KL 21547
1.000 x 1.500



KL 21548
.562 x 1.125

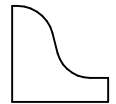

KL 23504
.500 x .500

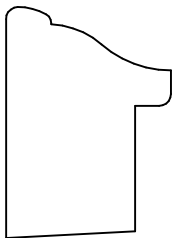

KL 21549
1.203 x .859

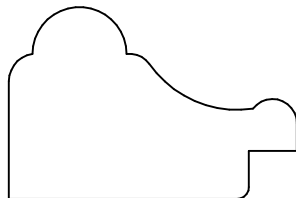

KL 21550
1.000 x 1.500

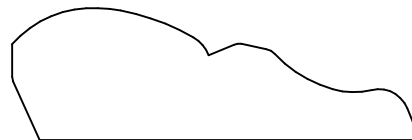

KL 21554
.688 x 2.125



KL 21551
.375 x .875

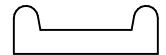

KL 21580
.250 x .750

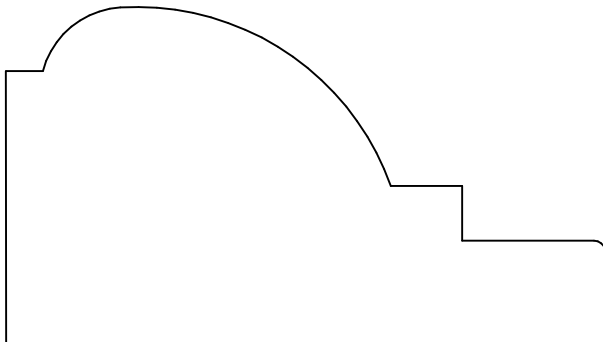

KL 21553
1.750 x 3.125

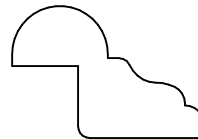

KL 21556
.688 x 1.000



KL 21564
.563 x .750

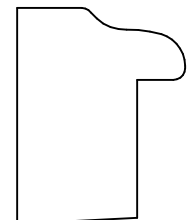

KL 21555
1.125 x .875

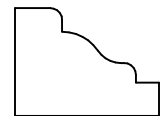

KL 21565
.562 x .750

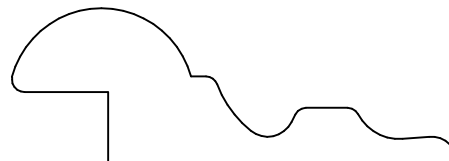

KL 21560
.812 x 2.312



KL 21567
.500 x .750

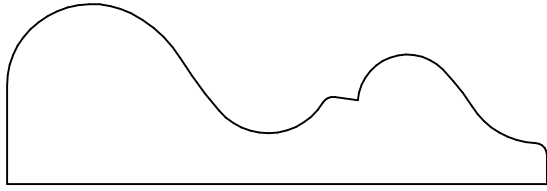

KL 21557
.938 x 2.812

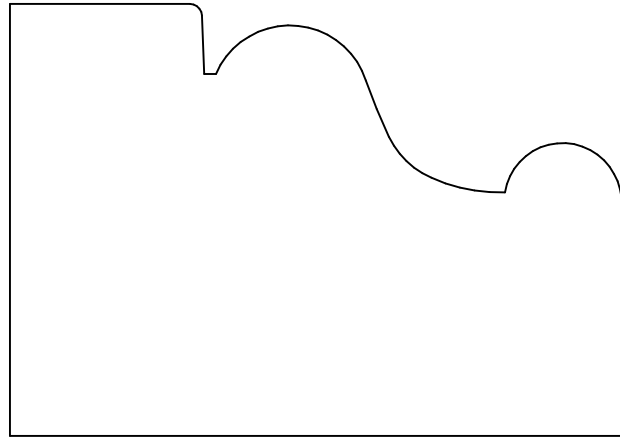

KL 21558
2.250 x 3.188

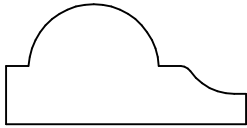

KL 21561
.625 x 1.250

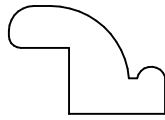

KL 21572
.562 x .812

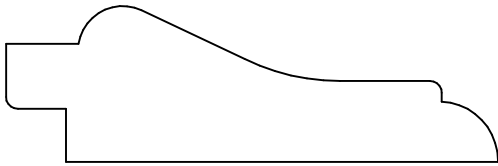

KL 21562
.812 x 2.562

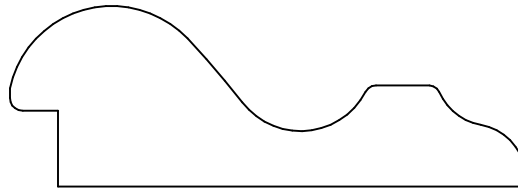

KL 21563
.940 x 2.687

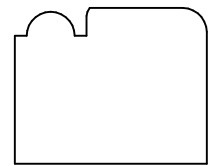

KL 21569
.812 x 1.000

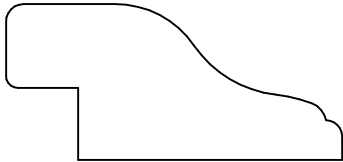

KL 21566
.812 x 1.750

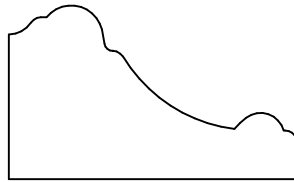

KL 21568
.905 x 1.500

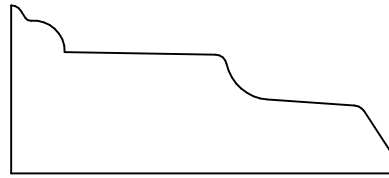

KL 21570
.875 x 2.000

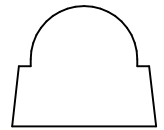

KL 21574
.627 x .750



KL 21571
.500 x 1.750

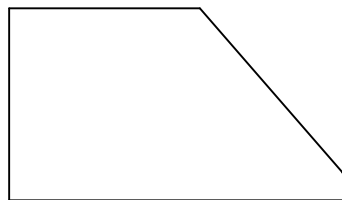

KL 21573
1.000 x 1.750

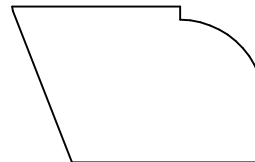

KL 21575
.812 x 1.312



KL 21576
.500 x 1.000

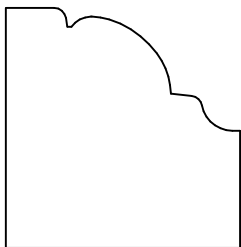

KL 21577
1.250 x 1.219

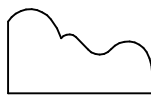

KL 21578
.438 x .750

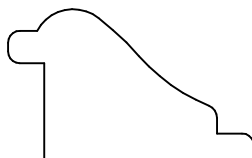

KL 21581
.781 x 1.281

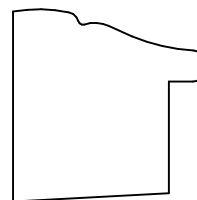

KL 21582
1.000 x 1.000

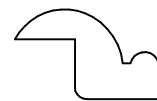

KL 21583
.468 x .750

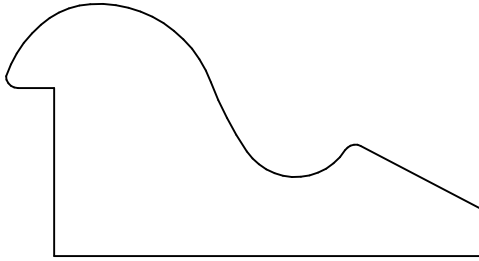

KL 21579
1.313 x 2.469

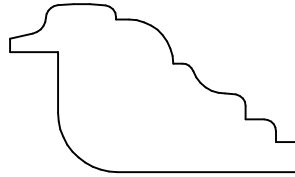

KL 21584
.875 x 1.500

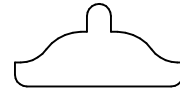

KL 21585
.430 x .875

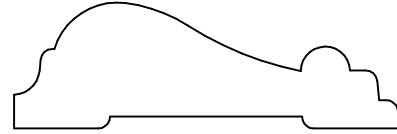

KL 21586
.656 x 2.000

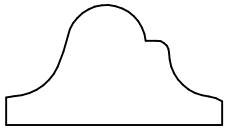

KL 21587
.625 x 1.125



KL 21588
.375 x 1.312



KL 21589
.375 x 1.312

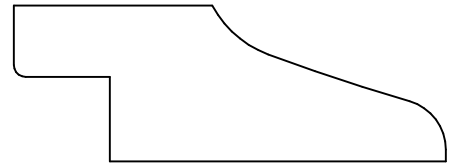

KL 21591
.812 x 2.250



KL 21599
.250 x .688

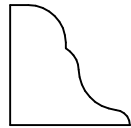

KL 21590
.625 x .625

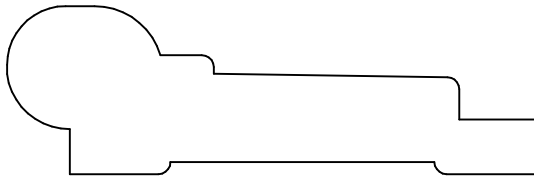

KL 21592
.875 x 2.750

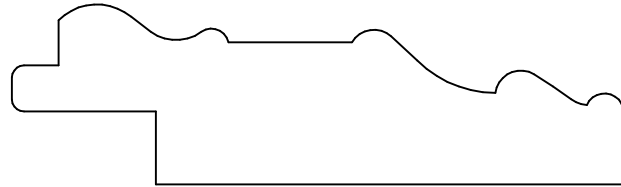

KL 21593
.938 x 3.187

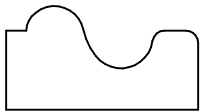

KL 21594
.540 x 1.000

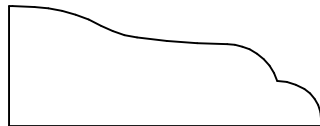

KL 21595
.625 x 1.625

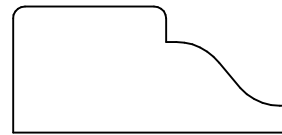

KL 21596
.656 x 1.438



KL 21598
.750 x 1.188

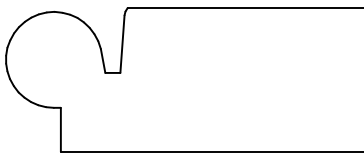

KL 23500
.750 x 1.875

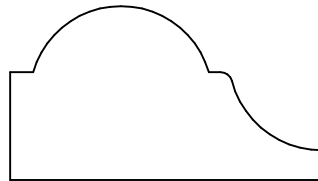

KL 23502
.906 x 1.625



KL 23503
.625 x 1.375

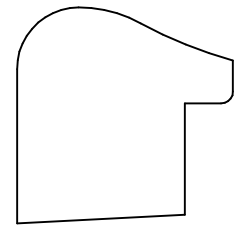

KL 23506
1.125 x 1.125



KL 23511
.345 x .875

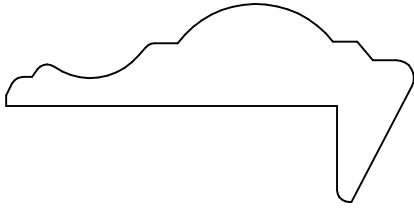

KL 23507
1.031 x 2.125

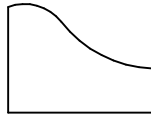

KL 23508
.566 x .750

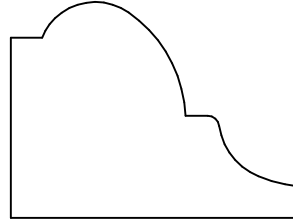

KL 23509
1.125 x 1.500

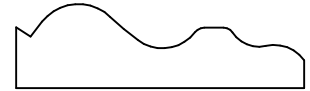

KL 23512
.438 x 1.500

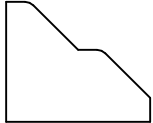

KL 23515
.625 x .750

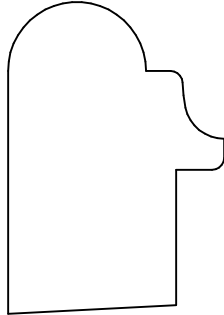

KL 23516
1.625 x 1.125

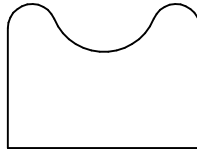

KL 23517
.750 x 1.000

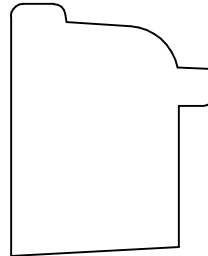

KL 23518
1.312 x 1.062

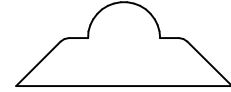

KL 23514
.437 x 1.125

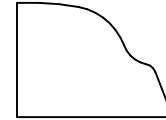

KL 23523
.594 x .812



KL 23589
.312 x .500

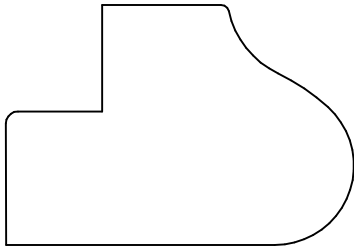

KL 23519
1.250 x 1.812

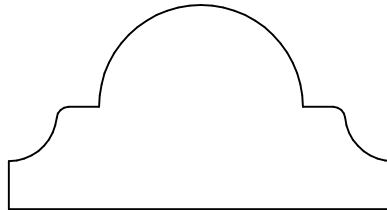

KL 23520
1.063 x 2.000

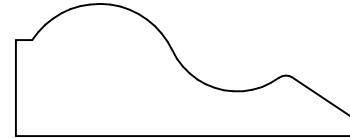

KL 23521
.688 x 1.750

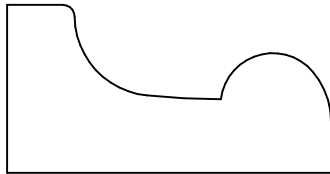

KL 23525
.875 x 1.688

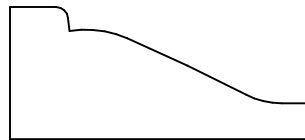

KL 23524
.688 x 1.562

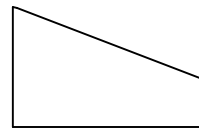

KL 23526
.625 x 1.000

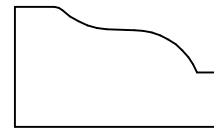

KL 23530
.625 x 1.062

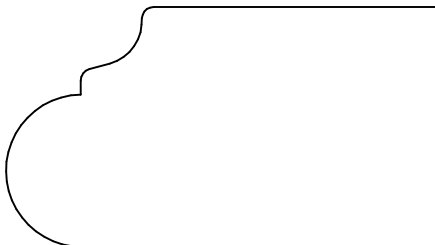

KL 23529
1.250 x 2.250



KL 23531
.500 x 2.250

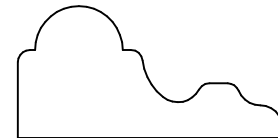

KL 23533
.688 x 1.375



KL 23534
.375 x .968

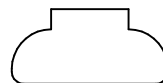

KL 23539
.389 x .812



KL 23567
.312 x .625

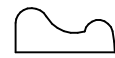

KL 23571
.230 x .515

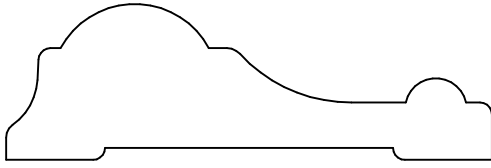

KL 23532
.812 x 2.531

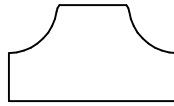

KL 23535
.500 x .875

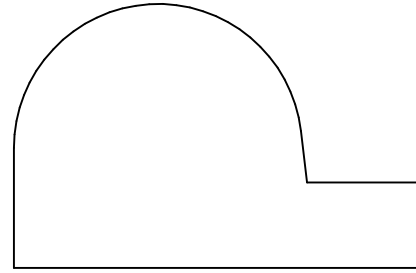

KL 23536
1.375 x 2.125



KL 24536
.250 x .375

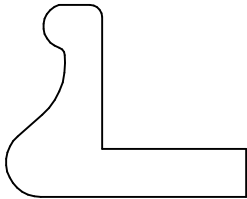

KL 23537
1.000 x 1.250

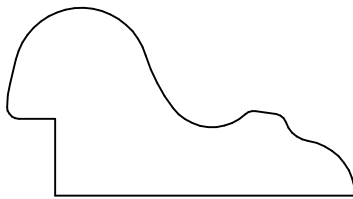

KL 23538
.977 x 1.812

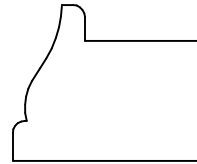

KL 23540
.812 x 1.000

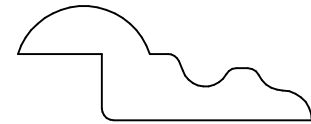

KL 23541
.595 x 1.531

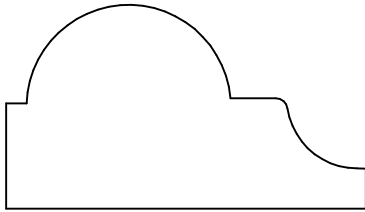

KL 23542
1.062 x 1.875

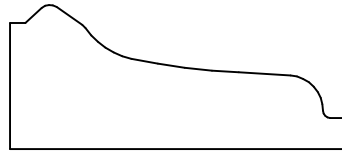

KL 23544
.750 x 1.750



KL 23545
1.000 x 2.125

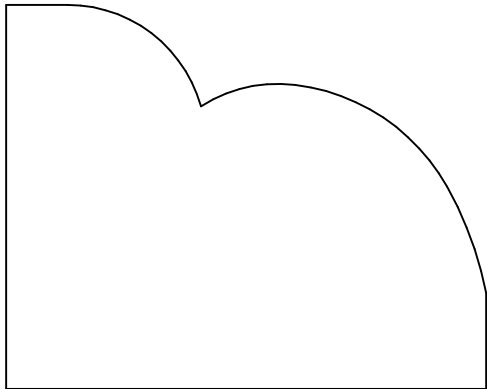

KL 23548
2.000 x 2.500



KL 23549
.250 x 2.250

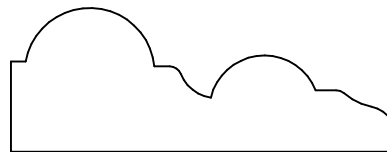

KL 23551
.750 x 2.000

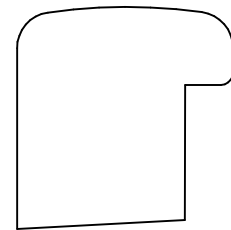

KL 23550
1.156 x 1.125

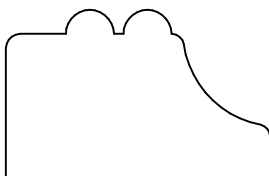

KL 23555
.875 x 1.375

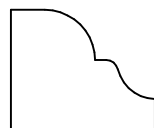

KL 23566
.625 x .750

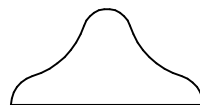

KL 23554
.500 x 1.000

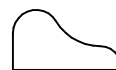

KL 23578
.312 x .562

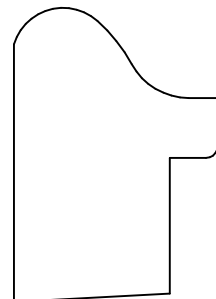

KL 23556
1.531 x 1.062

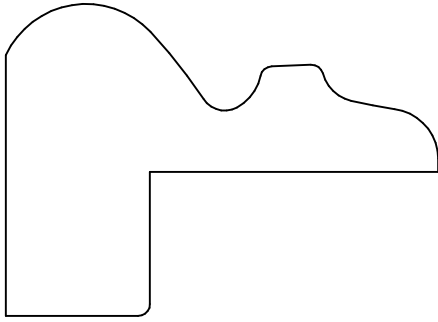

KL 23552
1.625 x 2.250

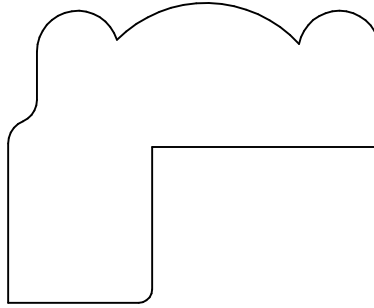

KL 23558
1.562 x 1.938

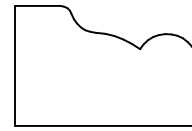

KL 23560
.625 x .938

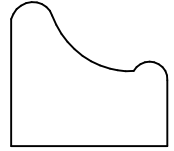

KL 23561
.750 x .814



KL 23562
.438 x 1.000



KL 23581
.312 x .625

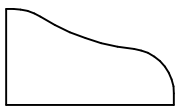

KL 23563
.500 x .875

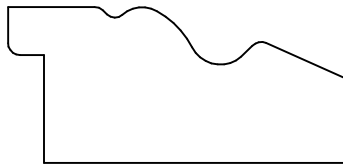

KL 23564
.812 x 1.750



KL 23565
.438 x 1.062



KL 23568
.453 x 1.000

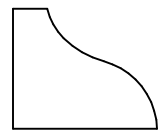

KL 23588
.625 x .750



KL 23570
.500 x 2.000

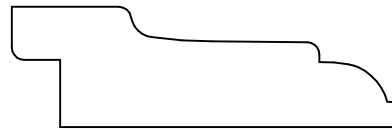

KL 23572
.625 x 2.000

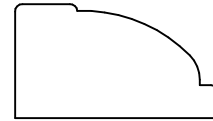

KL 23574
.594 x 1.060

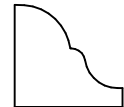

KL 24507
.531 x .563

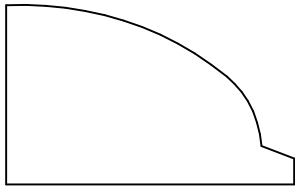

KL 23575
.935 x 1.500

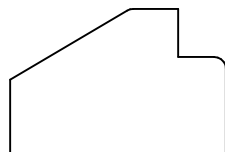

KL 23579
.750 x 1.125

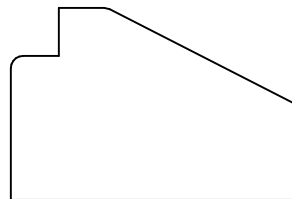

KL 23580
1.000 x 1.500

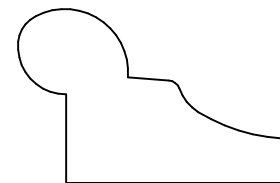

KL 23582
.906 x 1.375

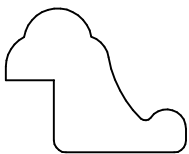

KL 23584
.750 x .938

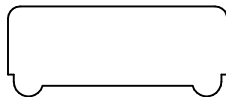

KL 23585
.468 x 1.141



KL 23586
.625 x 1.304

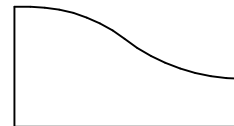

KL 23587
.625 x 1.187

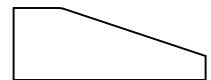

KL 23595
.375 x 1.000

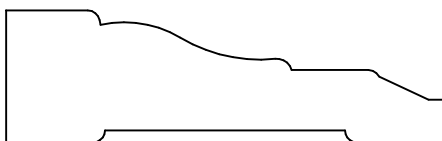

KL 23590
.688 x 2.281



KL 24504
.375 x 1.000



KL 24505
.562 x .688



KL 24506
.250 x 1.250

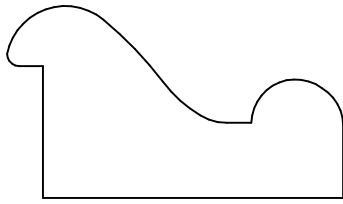

KL 23592
1.000 x 1.750

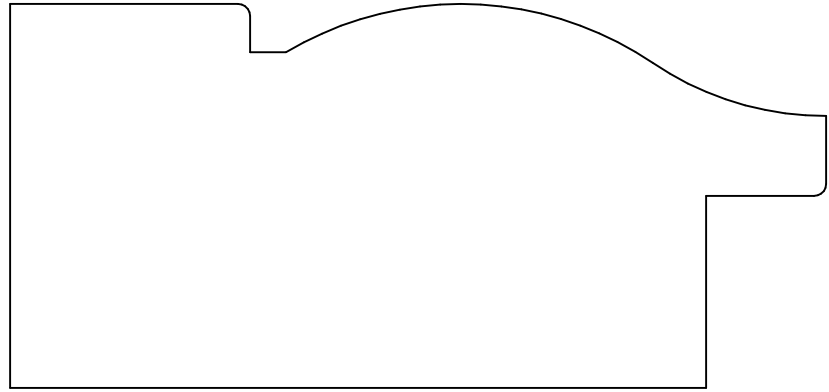

KL 23593
2.000 x 4.250

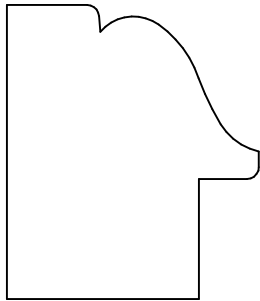

KL 23594
1.531 x 1.312

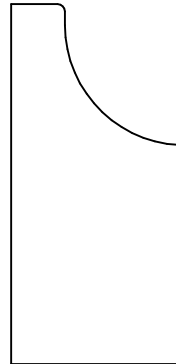

KL 24501
.875 x 1.875

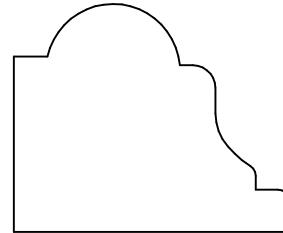

KL 24502
1.187 x 1.437



KL 24510
.375 x .750

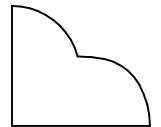

KL 24513
.625 x .719

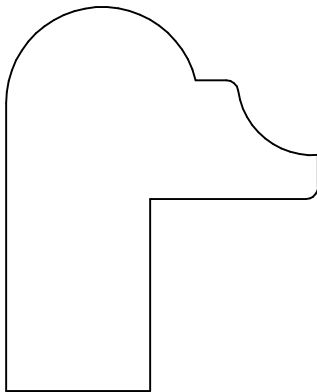

KL 23596
2.000 x 1.625

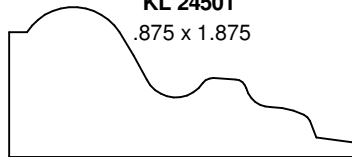

KL 24508
.781 x 1.812

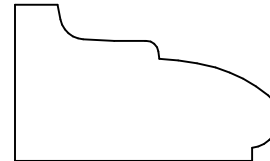

KL 24509
.812 x 1.375

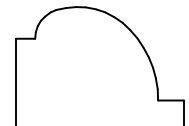

KL 24517
.625 x .875

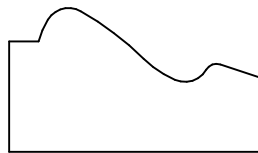

KL 24511
.750 x 1.312

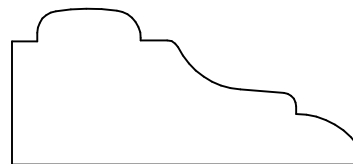

KL 24512
.812 x 1.812

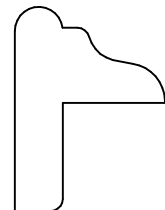

KL 24523
1.062 x .781

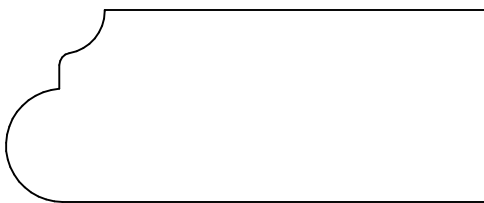

KL 24514
1.000 x 2.500



KL 24516
.750 x 1.500

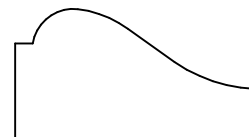

KL 24524
.687 x 1.250



KL 24528
.469 x .750

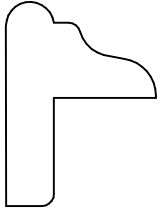

KL 24518
1.062 x .781

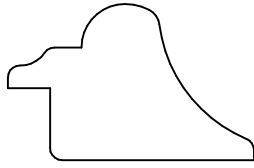

KL 24519
.812 x 1.281

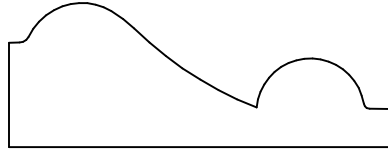

KL 24520
.750 x 2.000

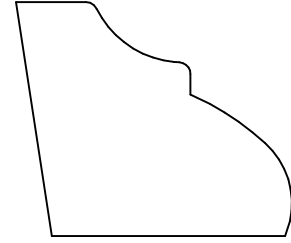

KL 24522
1.219 x 1.438

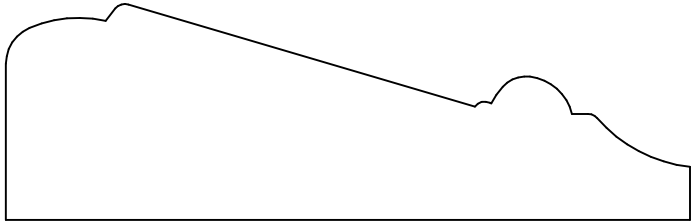

KL 24521
1.125 x 3.562

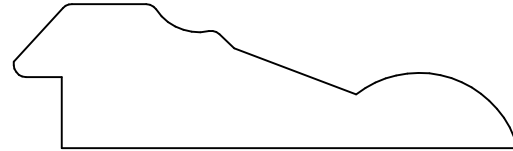

KL 24523
.750 x 2.625

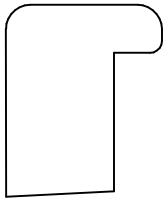

KL 24525
1.000 x .812

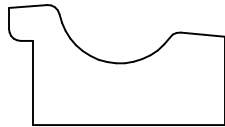

KL 24526
.625 x 1.125

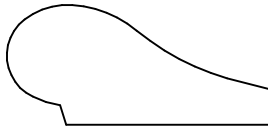

KL 24527
.625 x 1.375

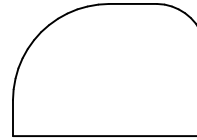

KL 24529
.688 x 1.000

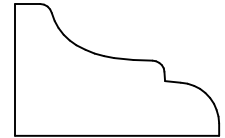

KL 24530
.687 x 1.062

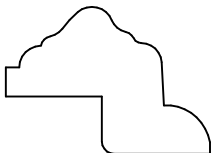

KL 24531
.765 x 1.062

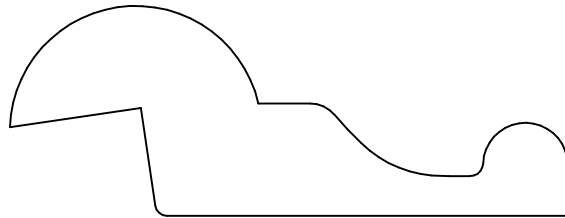

KL 24532
1.094 x 2.905

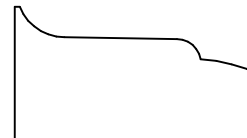

KL 24533
.687 x 1.250

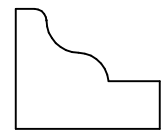

KL 24535
.625 x .750

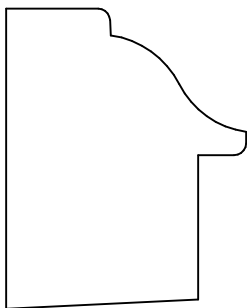

KL 24534
1.562 x 1.250

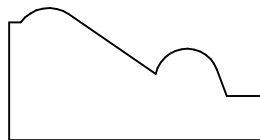

KL 24537
.688 x 1.312

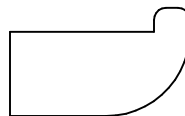

KL 24538
.563 x .938

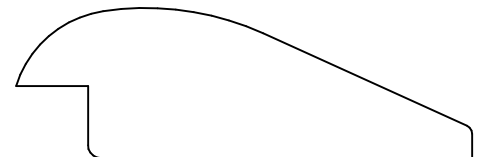

KL 24539
.781 x 2.375

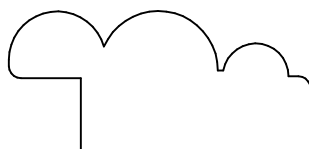

KL 24542
.725 x 1.570



KL 24543
.500 x .750

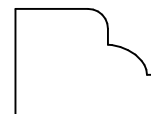

KL 24550
.562 x .750

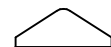

KL 24578
.198 x .500

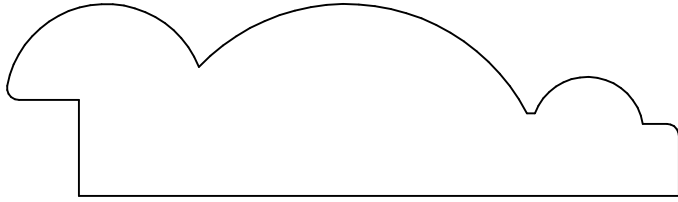

KL 24540
1.000 x 3.500

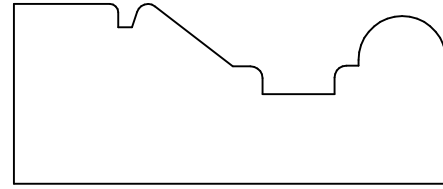

KL 24546
.937 x 2.250

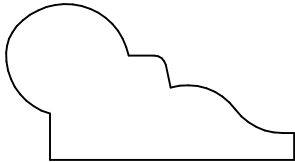

KL 24547
.812 x 1.500

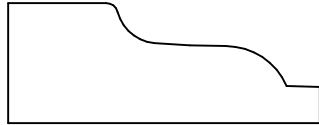

KL 24548
.625 x 1.625

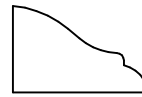

KL 24551
.451 x .703

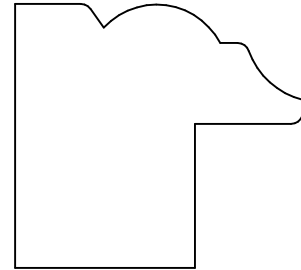

KL 24552
1.375 x 1.500



KL 24553
.500 x .750

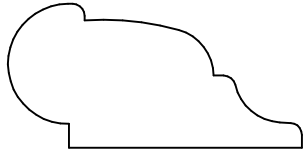

KL 24554
.750 x 1.531

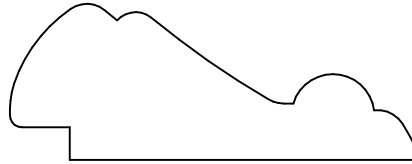

KL 24555
.812 x 2.125

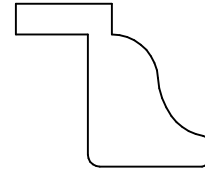

KL 24556
.848 x 1.000

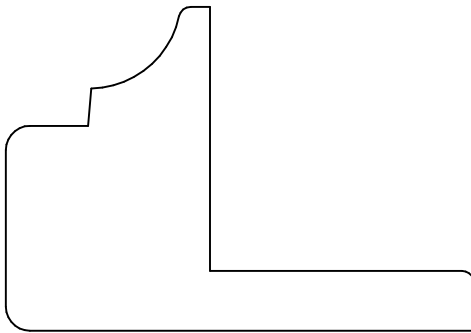

KL 24558
1.687 x 2.438

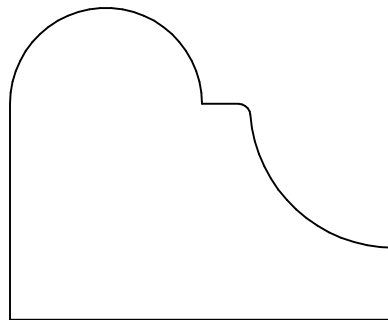

KL 24559
1.625 x 2.000

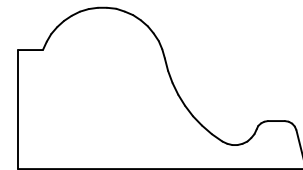

KL 24560
.841 x 1.500



KL 24561
.625 x 1.250

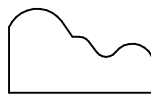

KL 24562
.437 x .750

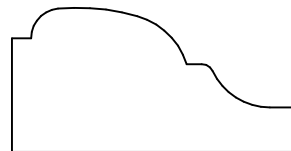

KL 24564
.750 x 1.500

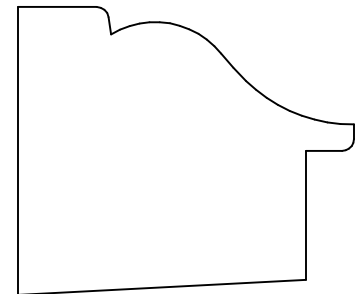

KL 24563
1.500 x 1.750



KL 24583
.500 x 1.500



KL 24594
.359 x .500

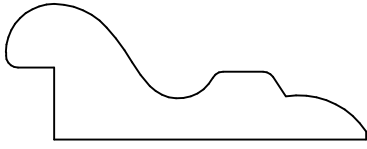

KL 24565
.706 x 1.875

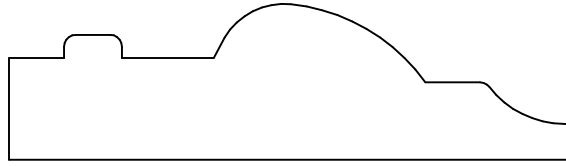

KL 24569
.812 x 2.938

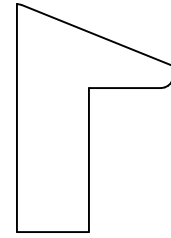

KL 24570
1.188 x .812

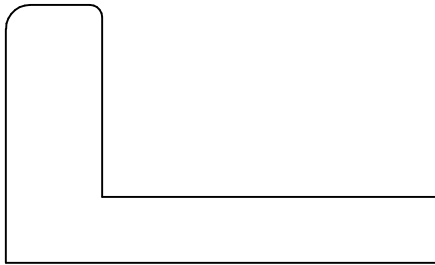

KL 24571
1.344 x 2.250

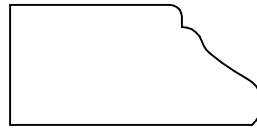

KL 24572
.625 x 1.312

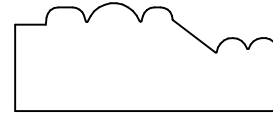

KL 24574
.562 x 1.375

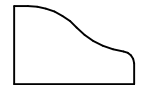

KL 25507
.406 x .625

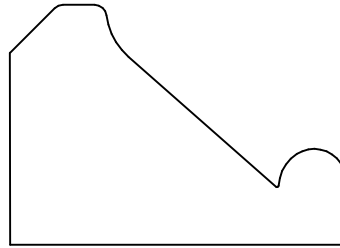

KL 24573
1.250 x 1.750

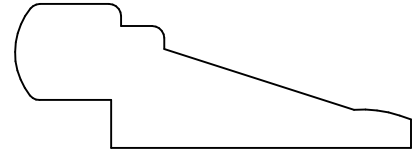

KL 24576
.750 x 2.062

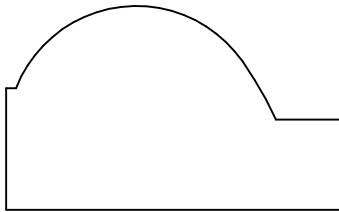

KL 24575
1.062 x 1.750



KL 24584
.438 x .688

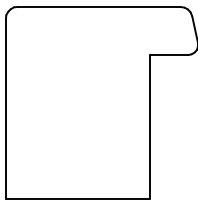

KL 24580
1.000 x 1.000

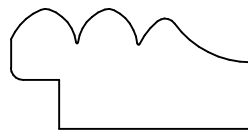

KL 24577
.625 x 1.250

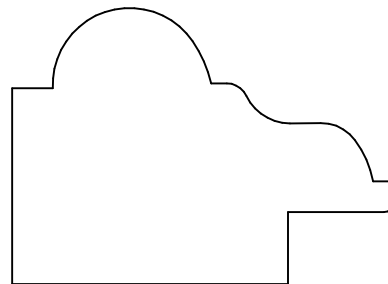

KL 24579
1.438 x 2.000

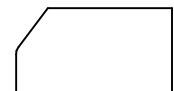

KL 24593
.437 x .812

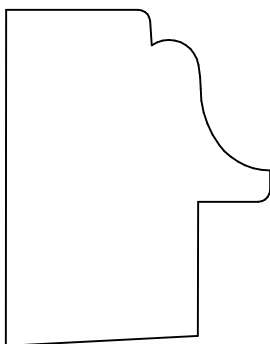

KL 24581
1.750 x 1.375

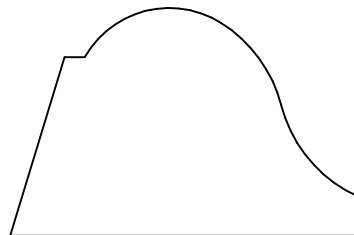

KL 24582
1.187 x 1.812

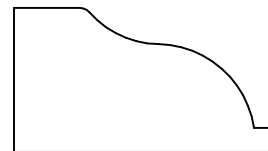

KL 24585
.750 x 1.375

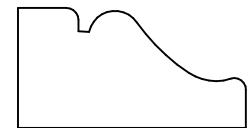

KL 24586
.625 x 1.188

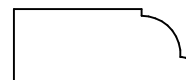

KL 24598
.375 x .937

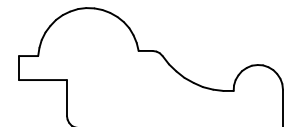

KL 24597
.625 x 1.375

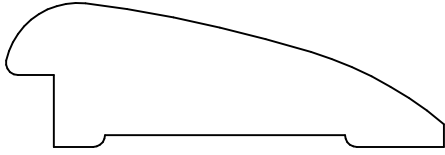

KL 24587
.750 x 2.281

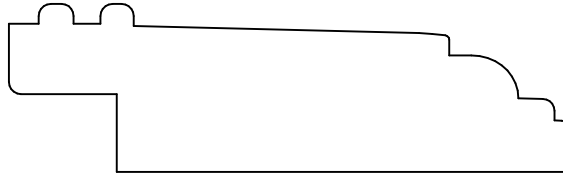

KL 24588
.875 x 2.937

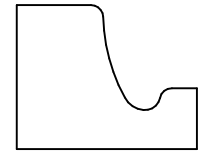

KL 24589
.750 x .938

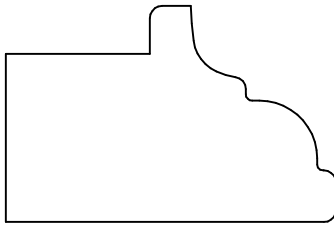

KL 24590
1.125 x 1.719

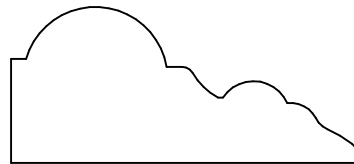

KL 24591
.812 x 1.812

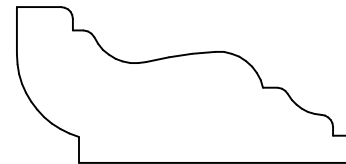

KL 24592
.812 x 1.750

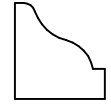

KL 25512
.500 x .469

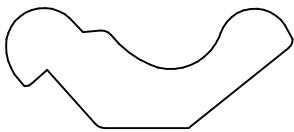

KL 24596
.625 x 1.493

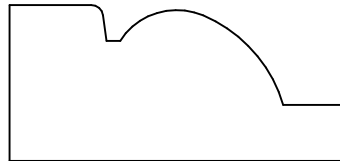

KL 24599
.812 x 1.750

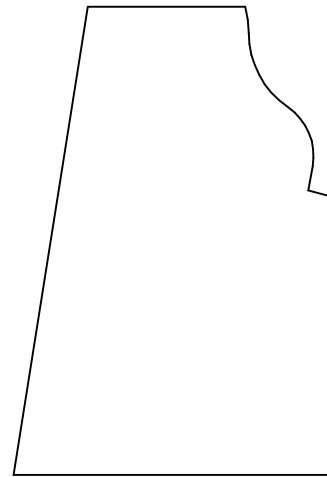

KL 25500
2.437 x 1.687

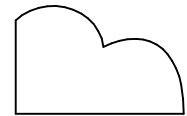

KL 25503
.562 x .875



KL 25508
.500 x .875



KL 25501
.406 x 3.125

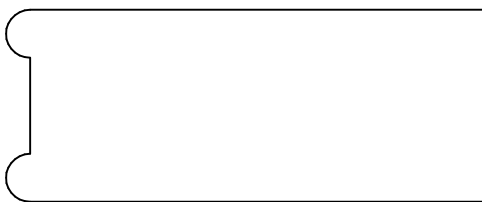

KL 25502
1.000 x 2.500

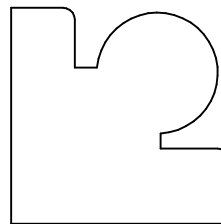

KL 25504
1.125 x 1.125

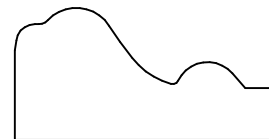

KL 25505
.688 x 1.375

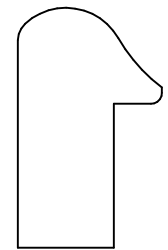

KL 25511
1.250 x .750

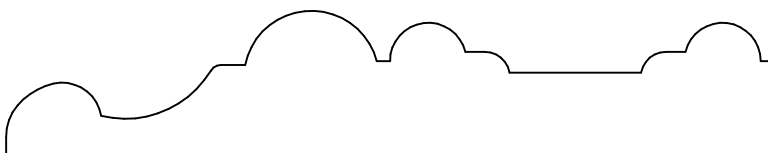

KL 25506
.750 x 4.000



KL 25509
.594 x 1.297

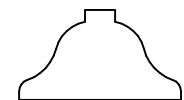

KL 25513
.469 x .844

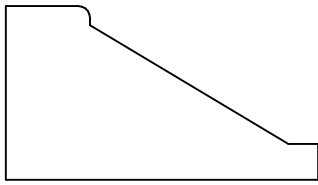

KL 25510
.906 x 1.625

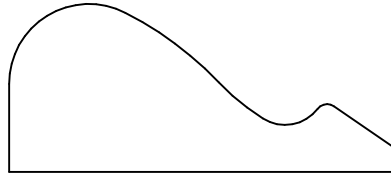

KL 25514
.875 x 2.000

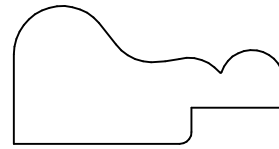

KL 25515
.718 x 1.406

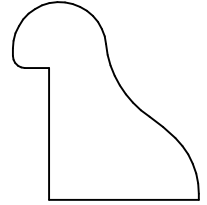

KL 25516
1.031 x .968

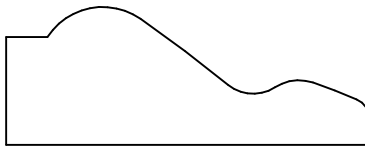

KL 25518
.719 x 1.875

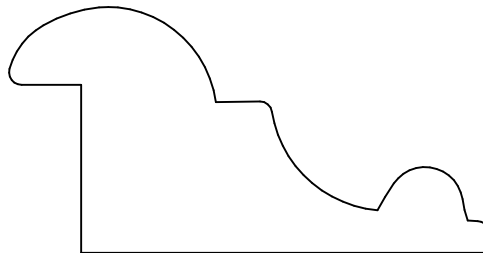

KL 25519
1.281 x 2.500

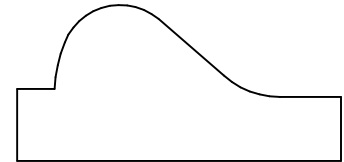

KL 25522
.812 x 1.688

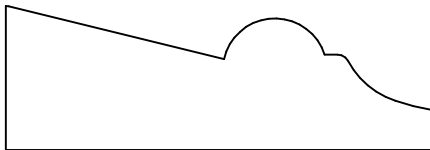

KL 25520
.750 x 2.219

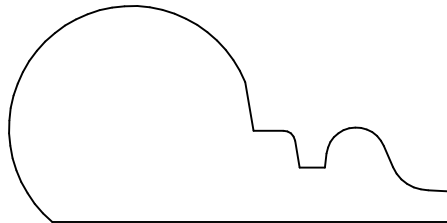

KL 25521
1.125 x 2.312

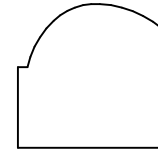

KL 25524
.750 x .750

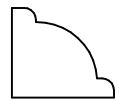

KL 25550
.468 x .531

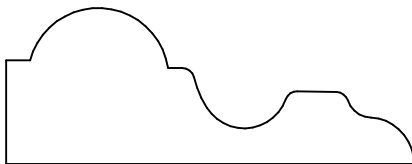

KL 25523
.812 x 2.125

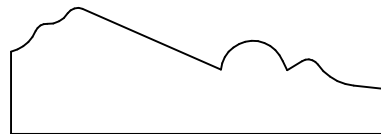

KL 25526
.656 x 1.969

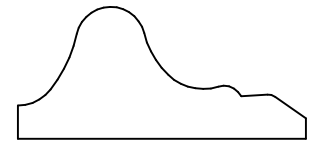

KL 25525
.687 x 1.500

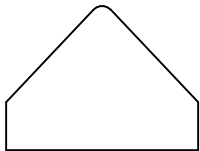

KL 25528
.750 x 1.000

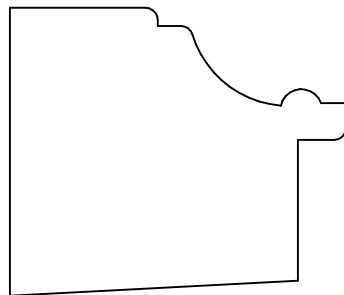

KL 25530
1.500 x 1.750

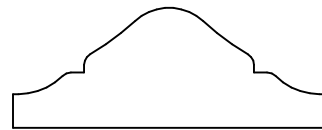

KL 25529
.625 x 1.625

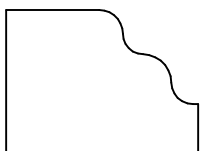

KL 25536
.750 x 1.000

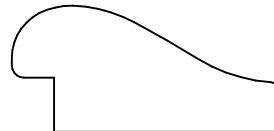

KL 25531
.656 x 1.406



KL 25533
.500 x 1.062

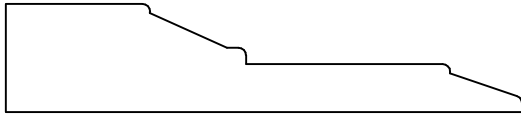

KL 25532
.562 x 2.688

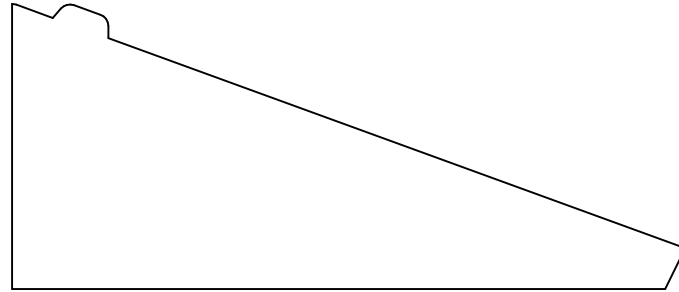

KL 25534
1.485 x 3.500

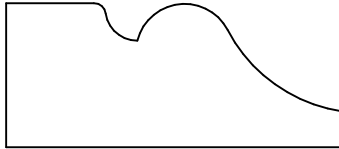

KL 25535
.750 x 1.750



KL 26526
.250 x .500

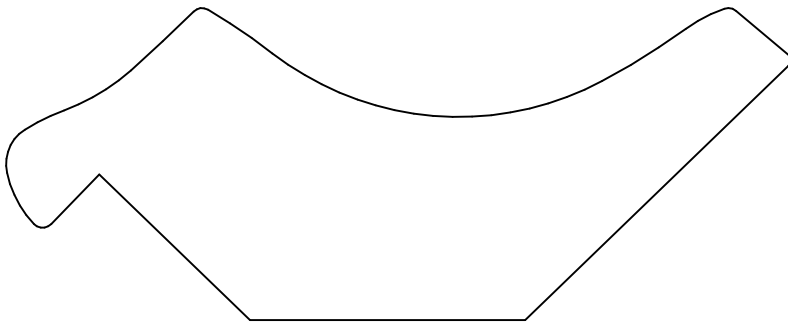

KL 25537
1.625 x 4.093

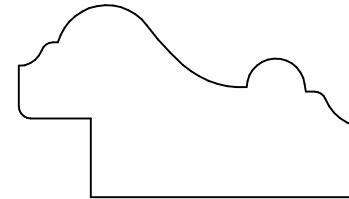

KL 25538
1.000 x 1.750

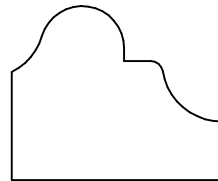

KL 25539
.906 x 1.125

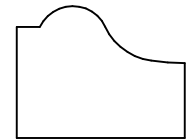

KL 25540
.687 x .875

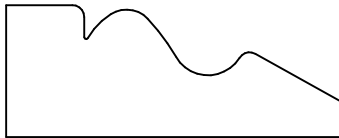

KL 25541
.687 x 1.750



KL 25542
.718 x 1.625

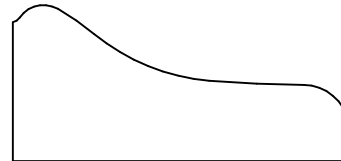

KL 25543
.812 x 1.750

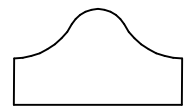

KL 25545
.500 x .875

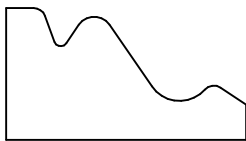

KL 25544
.687 x 1.250

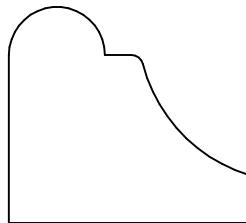

KL 25546
1.125 x 1.250

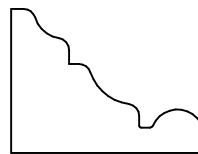

KL 25547
.750 x 1.000

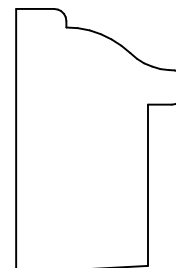

KL 25549
1.375 x .875

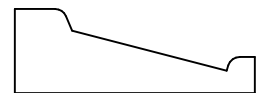

KL 25552
.437 x 1.250



KL 25553
.438 x 1.625

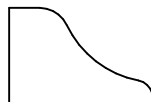

KL 25559
.500 x .750



KL 25568
.375 x 1.000

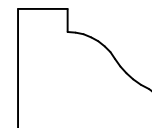

KL 25556
.625 x .718

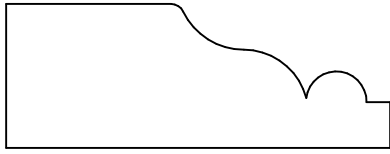

KL 25551
.750 x 2.000

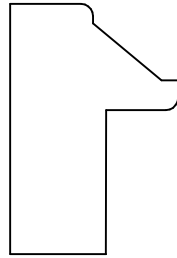

KL 25554
1.302 x .875

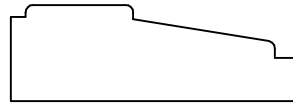

KL 25558
.500 x 1.500

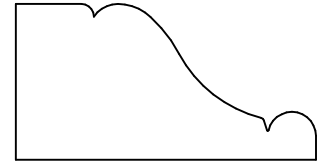

KL 25561
.812 x 1.562

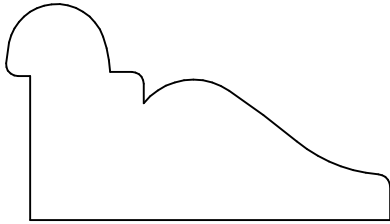

KL 25560
1.125 x 2.000

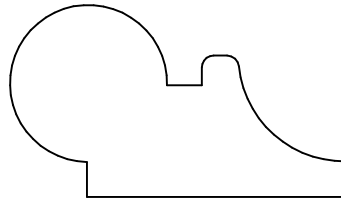

KL 25562
1.000 x 1.750

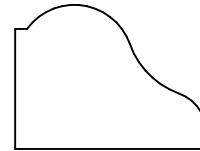

KL 25563
.750 x 1.000

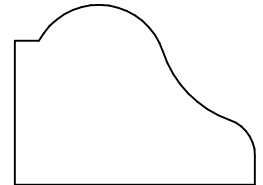

KL 25564
.938 x 1.250

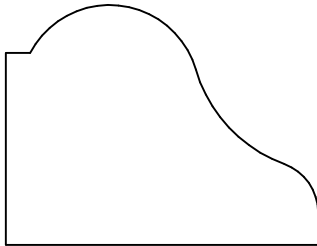

KL 25565
1.250 x 1.625

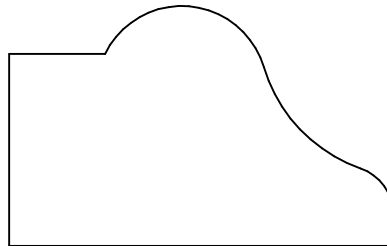

KL 25566
1.250 x 2.000

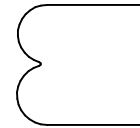

KL 25567
.625 x .687

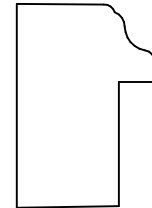

KL 25569
1.062 x .719

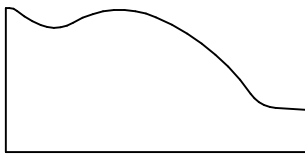

KL 25570
.750 x 1.562

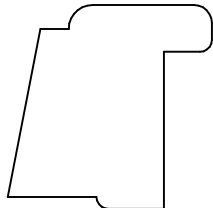

KL 25572
1.062 x 1.062

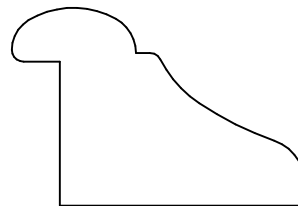

KL 25575
1.031 x 1.531

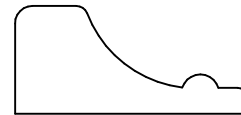

KL 25571
.562 x 1.218

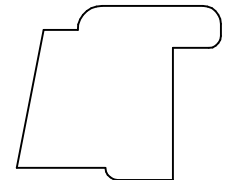

KL 25573
.906 x 1.062

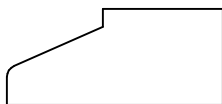

KL 25574
.500 x 1.125

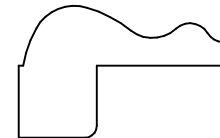

KL 25576
.687 x 1.062

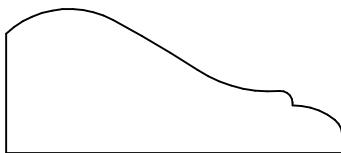

KL 25577
.750 x 1.750

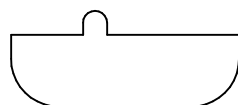

KL 25578
.500 x 1.187



KL 25579
.328 x 1.281

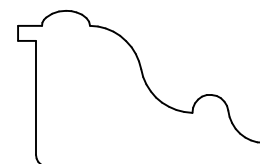

KL 25581
.812 x 1.281

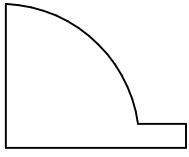

KL 25582
.750 x .937

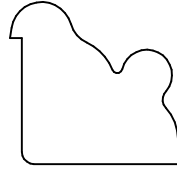

KL 25585
.844 x .875



KL 25586
.500 x 1.438

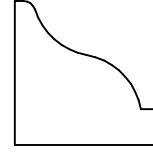

KL 25587
.750 x .750



KL 25588
.484 x .750

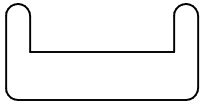

KL 25589
.500 x 1.000

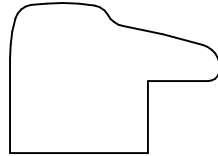

KL 25590
.781 x 1.094

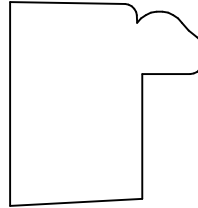

KL 25593
1.062 x 1.000



KL 26500
.284 x .619

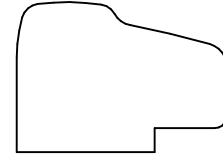

KL 25591
.781 x 1.094

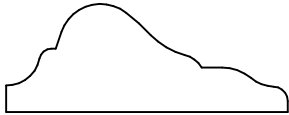

KL 25594
.562 x 1.468

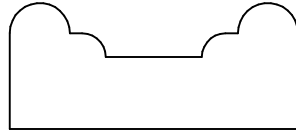

KL 25595
.656 x 1.500

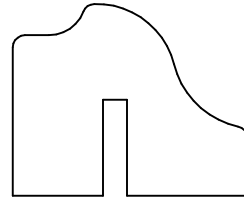

KL 25598
1.000 x 1.250



KL 26502
.500 x 1.250

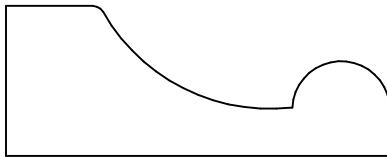

KL 25599
.781 x 2.000

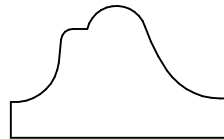

KL 26504
.688 x 1.125

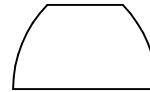

KL 26506
.438 x .750

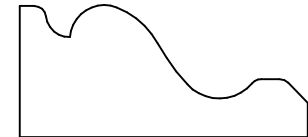

KL 26503
.688 x 1.500

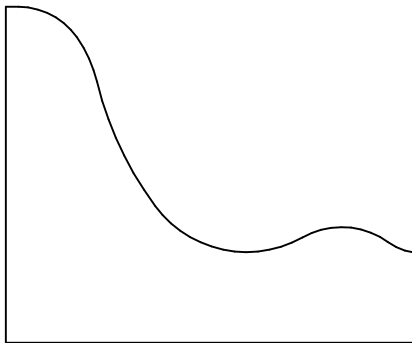

KL 26501
1.750 x 2.125



KL 26507
.438 x 1.125

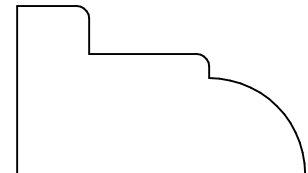

KL 26509
.875 x 1.500

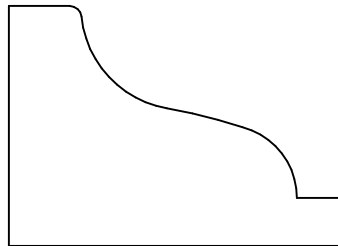

KL 26508
1.250 x 1.750

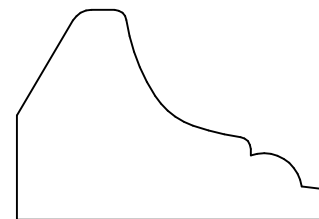

KL 26511
1.093 x 1.593

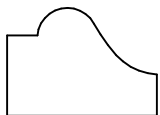

KL 26514
.562 x .781



KL 26517
.437 x .750

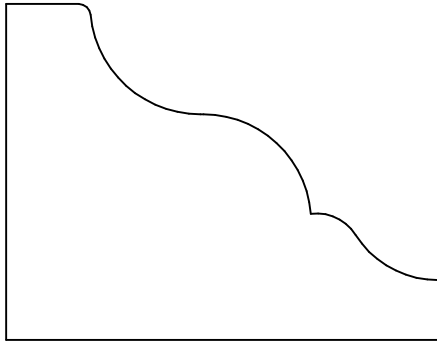

KL 26510
1.750 x 2.250

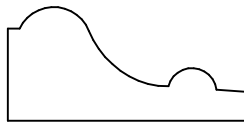

KL 26512
.593 x 1.250

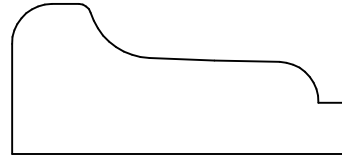

KL 26513
.781 x 1.750

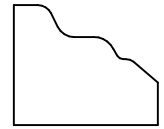

KL 26528
.625 x .750

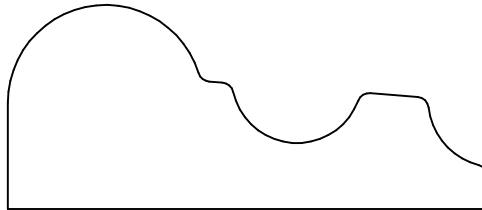

KL 26515
1.062 x 2.500

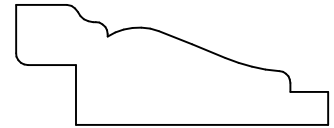

KL 26518
.625 x 1.625

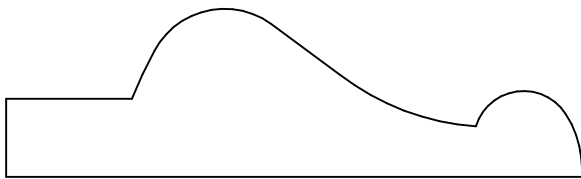

KL 26516
.875 x 3.000

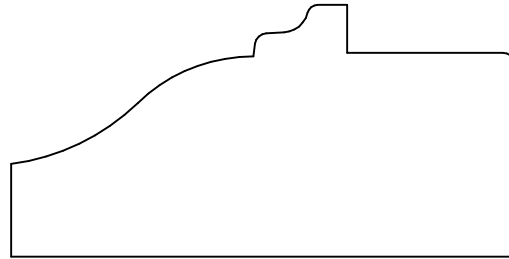

KL 26519
1.312 x 2.625



KL 26554
.394 x .625



KL 26565
.391 x .750

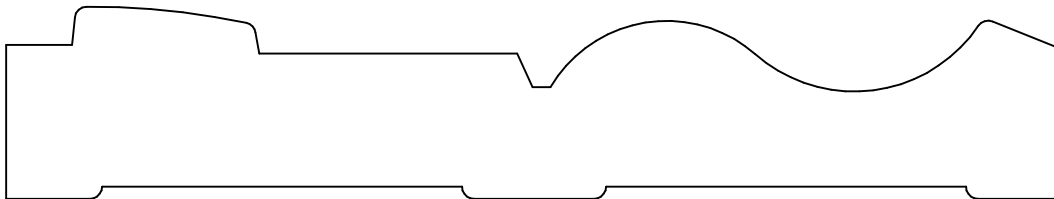

KL 26522
1.000 x 5.500

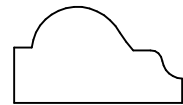

KL 26523
.500 x .875

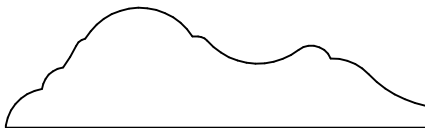

KL 26524
.625 x 2.188

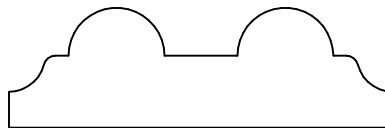

KL 26525
.625 x 2.000

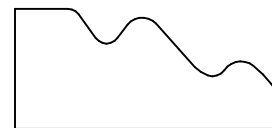

KL 26527
.625 x 1.375



KL 26589
.500 x .375



KL 26591
.250 x .313

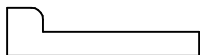

KL 26574
.250 x 1.000



KL 26578
.375 x 1.125

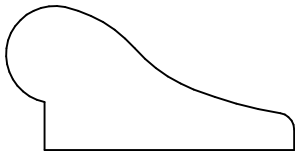

KL 26529
.750 x 1.500

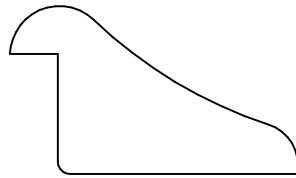

KL 26530
.875 x 1.500

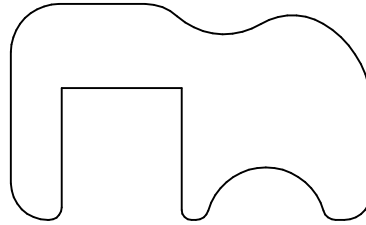

KL 26531
1.125 x 1.875

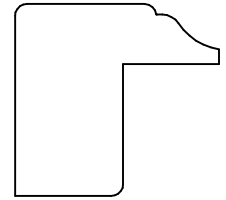

KL 26532
1.000 x 1.063



KL 26533
.500 x 1.250



KL 26534
.562 x 1.500

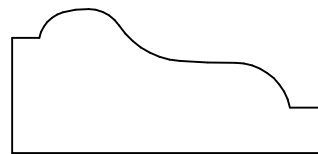

KL 26535
.750 x 1.625

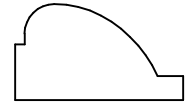

KL 26537
.500 x .875

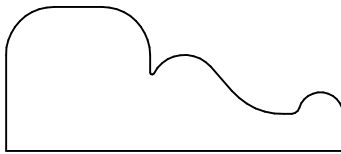

KL 26536
.750 x 1.750

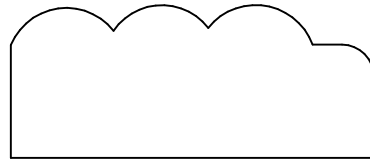

KL 26538
.796 x 1.890

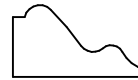

KL 27506
.375 x .688

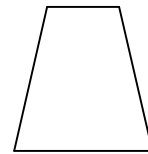

KL 26539
.750 x .720

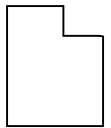

KL 26585
.625 x .500

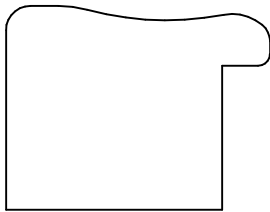

KL 26540
1.062 x 1.375

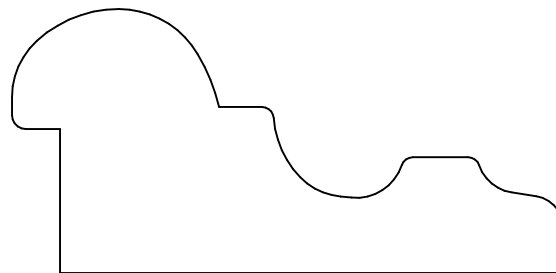

KL 26541
1.375 x 2.875

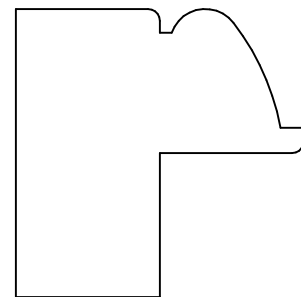

KL 26542
1.500 x 1.500

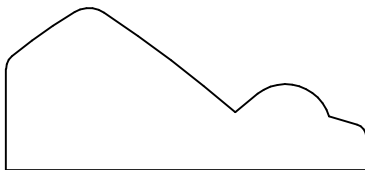

KL 26543
.844 x 1.875

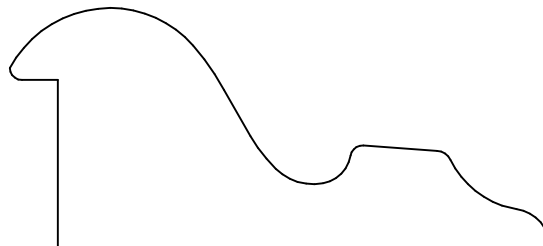

KL 26544
1.250 x 2.813

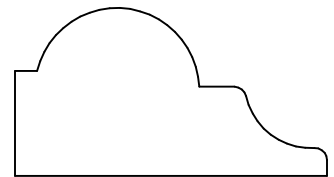

KL 26546
.875 x 1.625

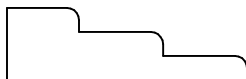

KL 26594
.375 x 1.250

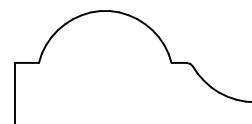

KL 26550
.600 x 1.250

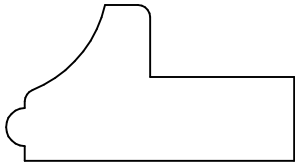

KL 26548
.812 x 1.500

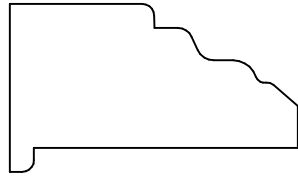

KL 26549
.875 x 1.500

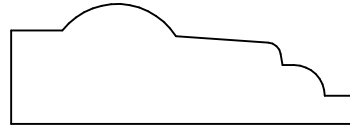

KL 26551
.625 x 1.812



KL 26557
.500 x 1.000

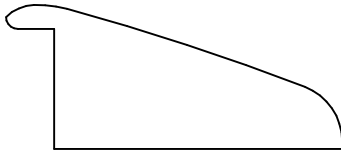

KL 26552
.750 x 1.750

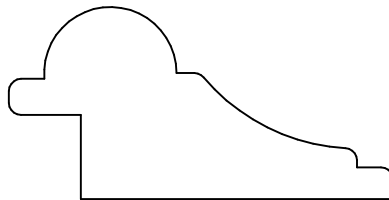

KL 26553
1.000 x 2.000

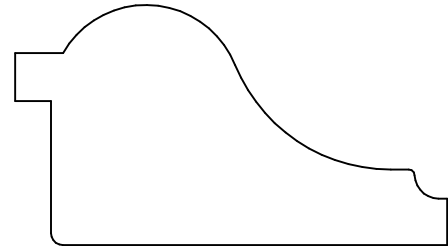

KL 26555
1.250 x 2.250

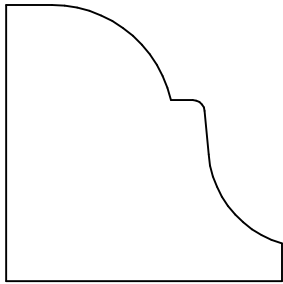

KL 26556
1.438 x 1.438

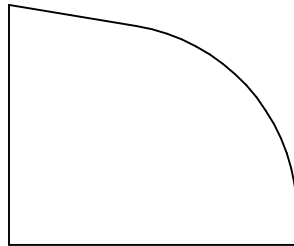

KL 26558
1.250 x 1.500

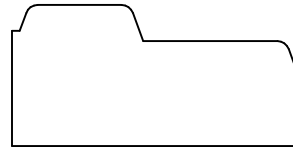

KL 26561
.735 x 1.500

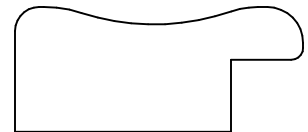

KL 26562
.650 x 1.500

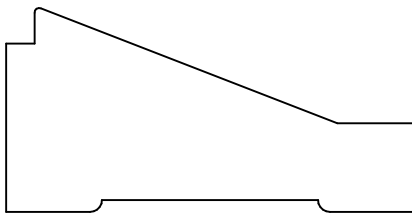

KL 26563
1.062 x 2.125

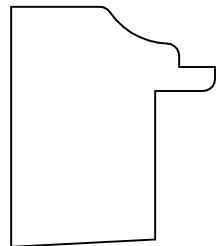

KL 26566
1.250 x 1.062

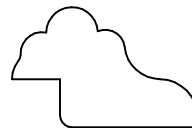

KL 26567
.625 x .968



KL 27507
.296 x .750

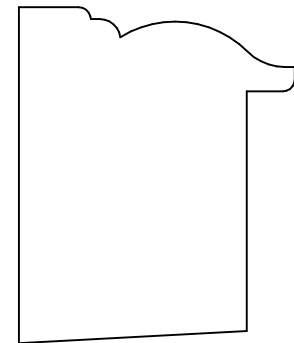

KL 26568
1.750 x 1.437

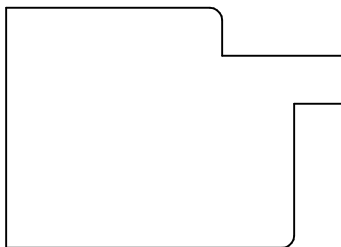

KL 26569
1.250 x 1.375

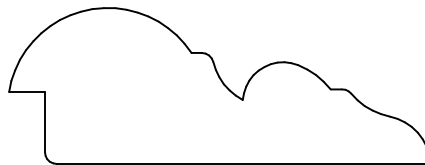

KL 26570
.813 x 2.187

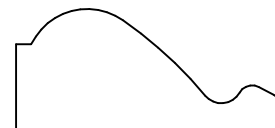

KL 26572
.625 x 1.375

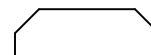

KL 27537
.250 x .750

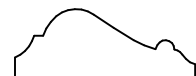

KL 27539
.375 x .938

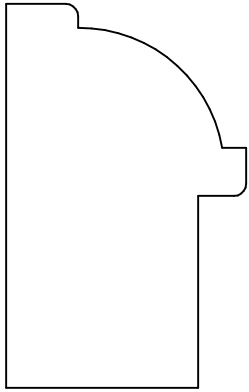

KL 26571
2.000 x 1.250

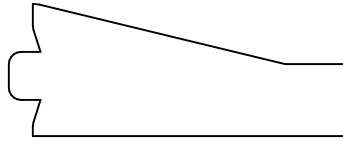

KL 26573
.688 x 1.750

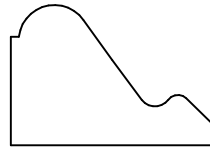

KL 26575
.730 x 1.062

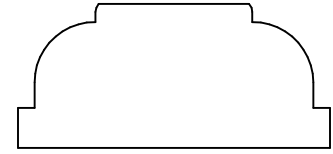

KL 26576
.750 x 1.625

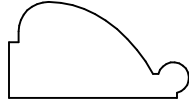

KL 26577
.500 x .938

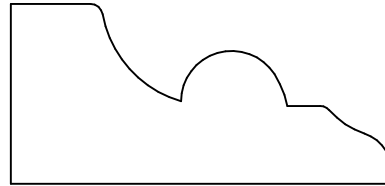

KL 26580
.937 x 1.984

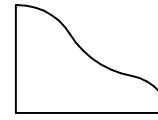

KL 26582
.562 x .750

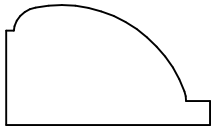

KL 26590
.625 x 1.063

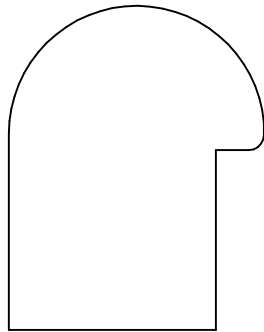

KL 26579
1.688 x 1.328

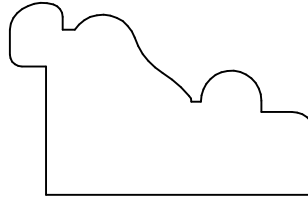

KL 26581
1.000 x 1.593

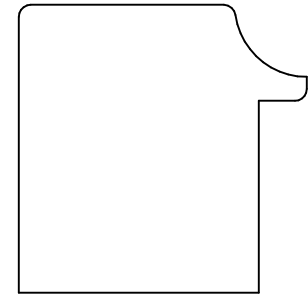

KL 26588
1.500 x 1.500

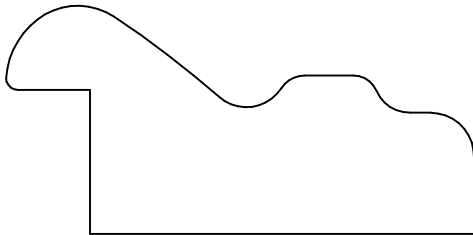

KL 26583
1.188 x 2.437

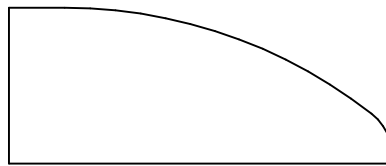

KL 26584
.812 x 2.000

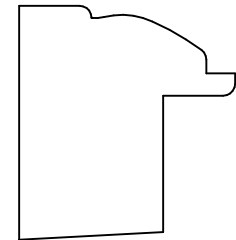

KL 26595
1.218 x 1.125

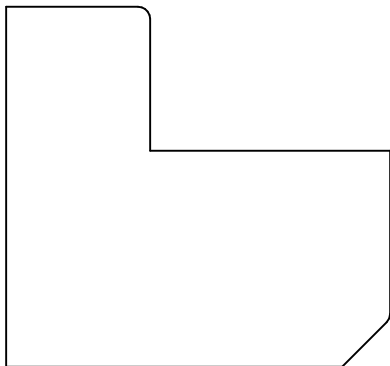

KL 26586
1.875 x 2.000

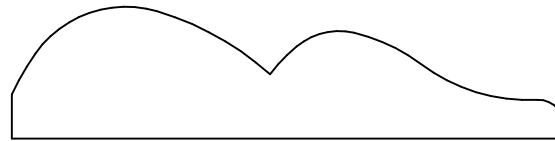

KL 26587
.688 x 2.875

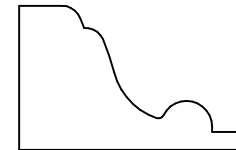

KL 26596
.750 x 1.140

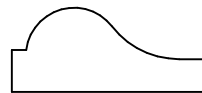

KL 27510
.438 x 1.000



KL 27541
.500 x .625

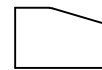

KL 27559
.312 x .500

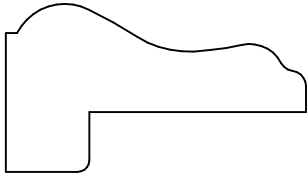

KL 26597
.875 x 1.562

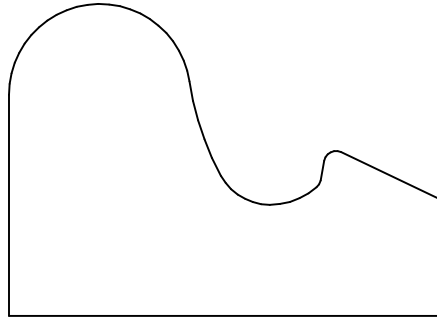

KL 26598
1.625 x 2.250

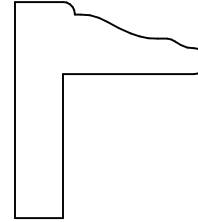

KL 26599
1.125 x 1.000

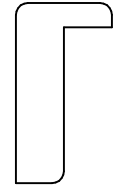

KL 27500
.938 x .500

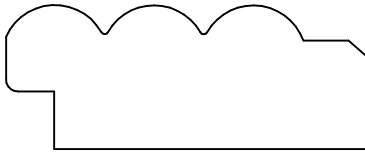

KL 27501
.750 x 1.875

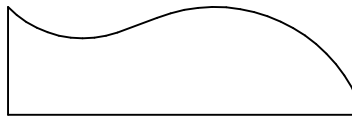

KL 27502
.562 x 1.812

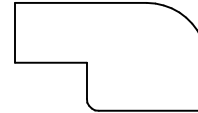

KL 27513
.562 x 1.000

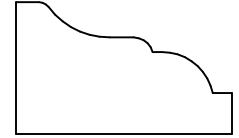

KL 27505
.688 x 1.125

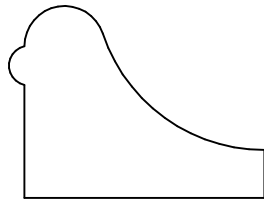

KL 27508
1.000 x 1.330



KL 27514
.562 x 1.562

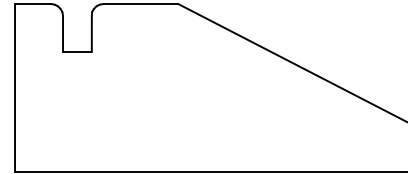

KL 27515
.875 x 2.062

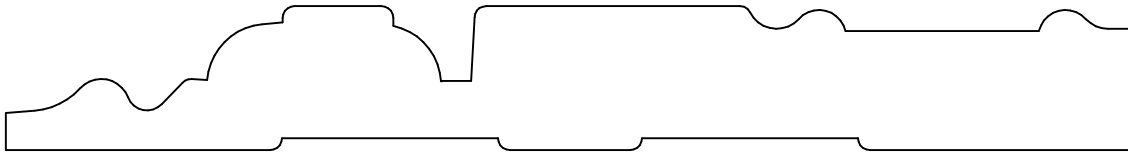

KL 27511
.750 x 5.875

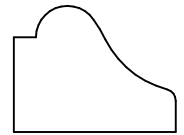

KL 27517
.656 x .843



KL 27526
.562 x .812

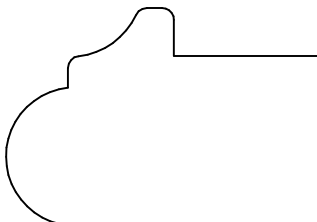

KL 27516
1.125 x 1.625

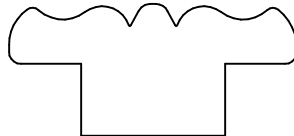

KL 27518
.687 x 1.500

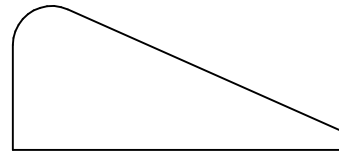

KL 27519
.750 x 1.750

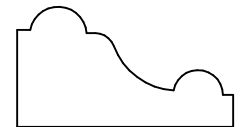

KL 27529
.625 x 1.125

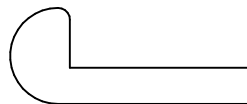

KL 27522
.500 x 1.250



KL 27536
.500 x 1.125

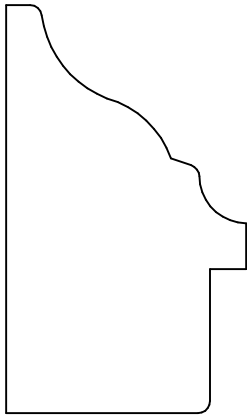

KL 27512
2.125 x 1.250

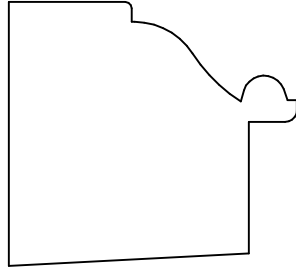

KL 27520
1.375 x 1.500

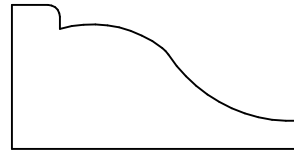

KL 27521
.750 x 1.500

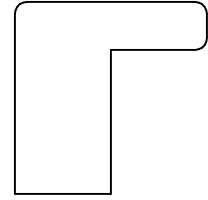

KL 27523
1.000 x 1.000

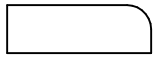

KL 27563
.250 x .750

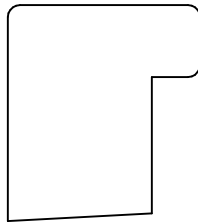

KL 27525
1.125 x 1.000

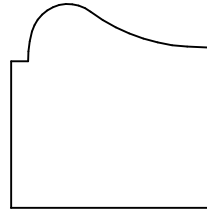

KL 27527
1.062 x 1.062

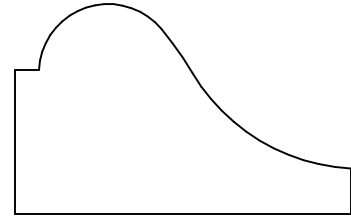

KL 27528
1.094 x 1.750

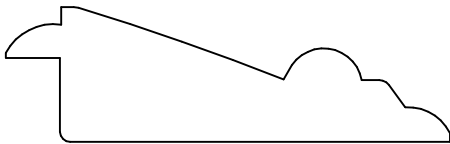

KL 27531
.703 x 2.312

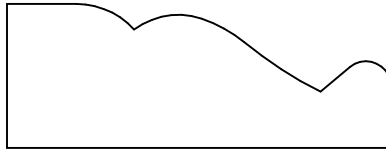

KL 27532
.750 x 2.000

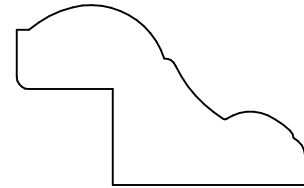

KL 27533
.937 x 1.500

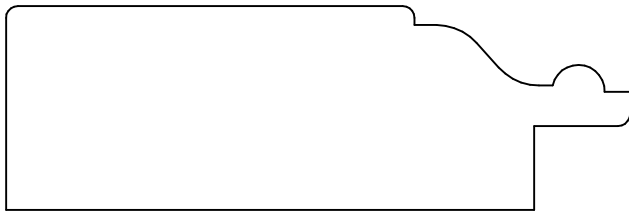

KL 27534
1.062 x 3.250

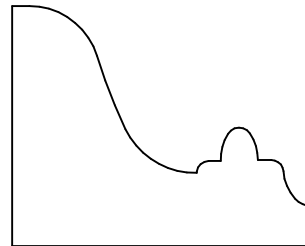

KL 27535
1.250 x 1.562

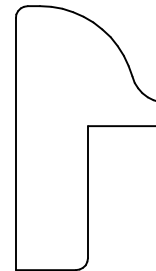

KL 27540
1.375 x .750



KL 27578
.375 x .375

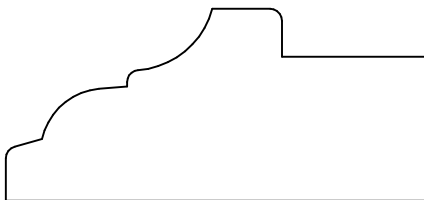

KL 27538
1.000 x 2.187

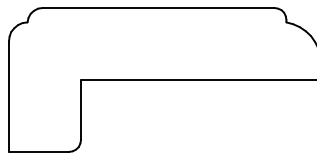

KL 27542
.750 x 1.625

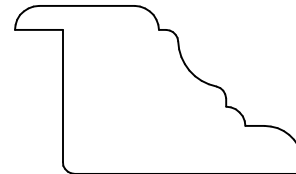

KL 27545
.875 x 1.500

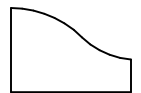

KL 27568
.438 x .625



KL 27571
.375 x .625

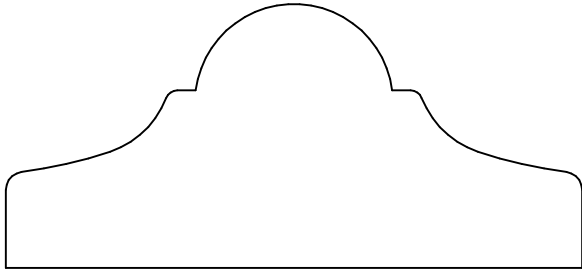

KL 27543
1.375 x 3.000

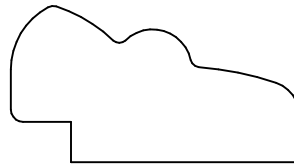

KL 27546
.813 x 1.500

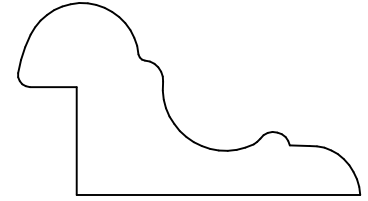

KL 27547
1.000 x 1.781

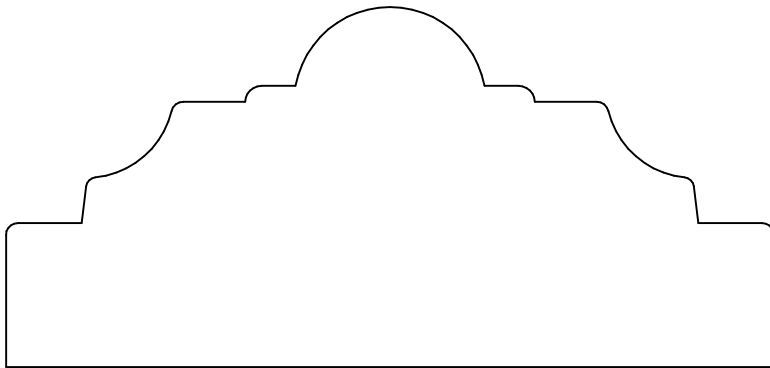

KL 27544
1.875 x 4.000

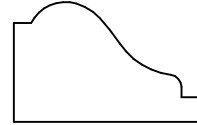

KL 27548
.625 x 1.000

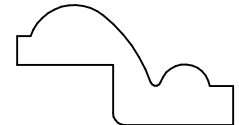

KL 27553
.625 x 1.125

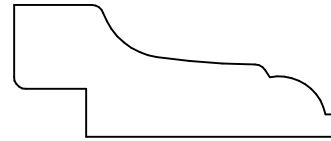

KL 27549
.687 x 1.688



KL 27588
.375 x .562

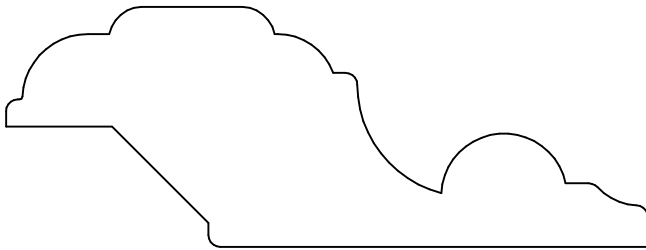

KL 27550
1.250 x 3.343

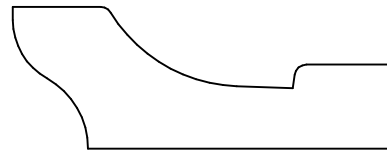

KL 27551
.738 x 2.000



KL 27557
.500 x .750



KL 27552
.600 x 2.312

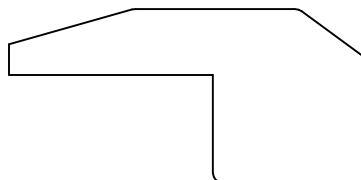

KL 27554
.906 x 1.875

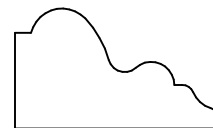

KL 27555
.625 x 1.063

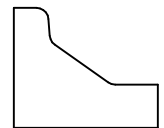

KL 27570
.625 x .750

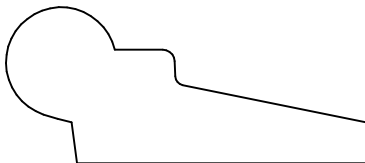

KL 27558
.813 x 1.875



KL 27567
.563 x .813

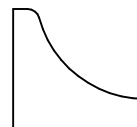

KL 27576
.625 x .687

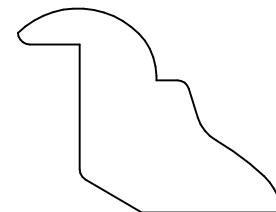

KL 27560
1.062 x 1.375

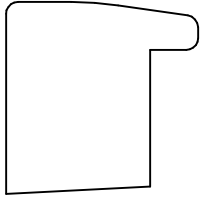

KL 27562
1.000 x 1.000

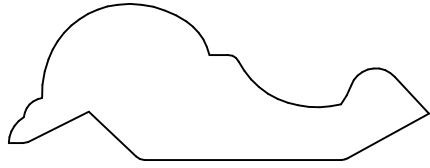

KL 27564
.812 x 2.188

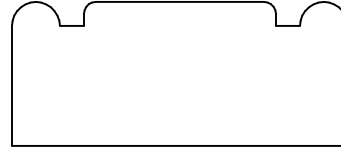

KL 27565
.750 x 1.750

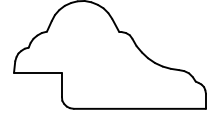

KL 27574
.562 x 1.000

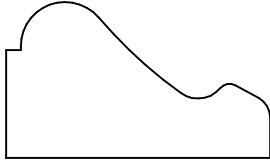

KL 27566
.812 x 1.375

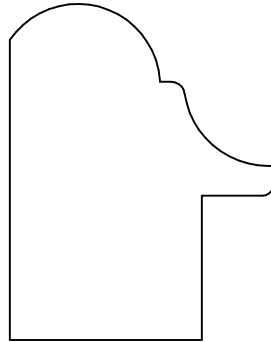

KL 27569
1.750 x 1.375

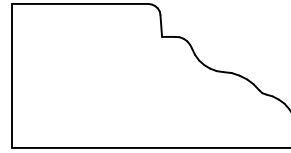

KL 27573
.750 x 1.500

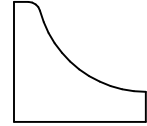

KL 27576
.625 x .687

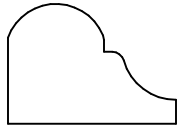

KL 27577
.625 x .875

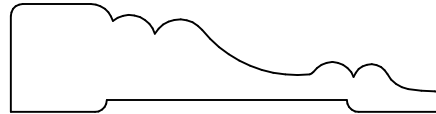

KL 27575
.563 x 2.250



KL 27580
.406 x .750

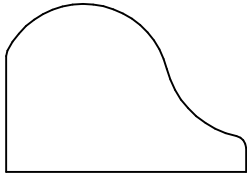

KL 27579
.875 x 1.250

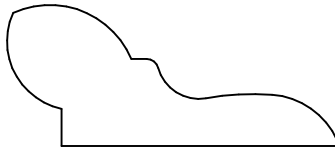

KL 27581
.734 x 1.719

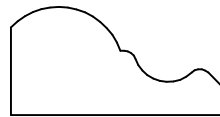

KL 27582
.563 x 1.125

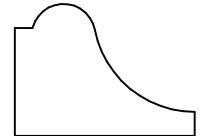

KL 27583
.687 x .938

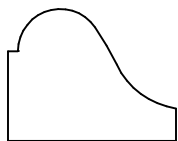

KL 27593
.687 x .875

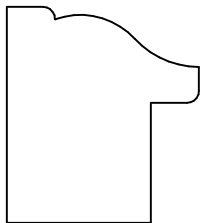

KL 27587
1.125 x 1.000



KL 27590
.500 x 1.875

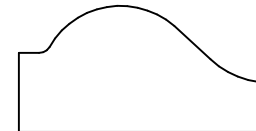

KL 27591
.656 x 1.250

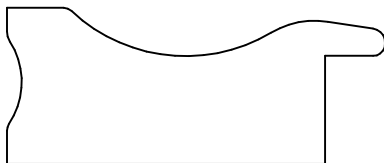

KL 27594
.813 x 1.969

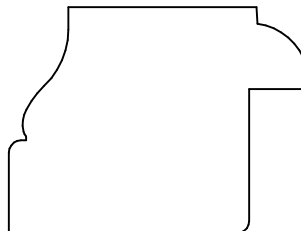

KL 27592
1.177 x 1.563

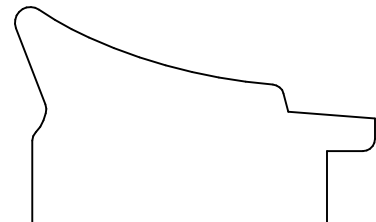

KL 27595
1.125 x 1.875

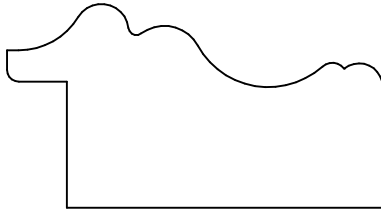

KL 27596
1.062 x 1.956

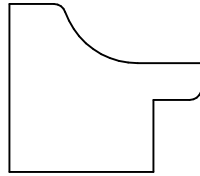

KL 27597
.875 x 1.000

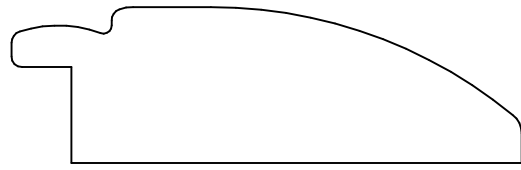

KL 27598
.813 x 2.656



KL 27599
.750 x 1.500

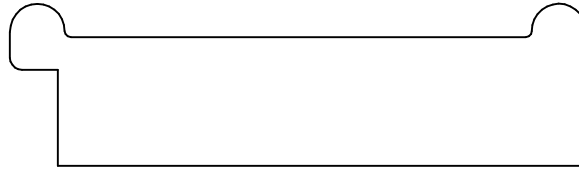

KL 29500
.844 x 3.000

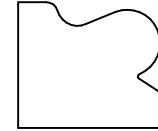

KL 29501
.656 x .750



KL 29508
.375 x .750

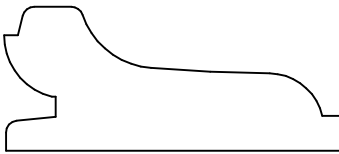

KL 29502
.750 x 1.750

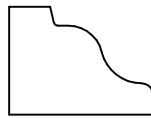

KL 29503
.563 x .750

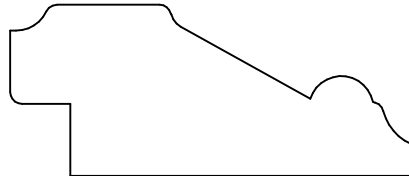

KL 29504
.891 x 2.125

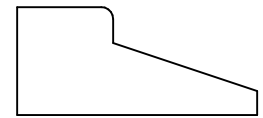

KL 29506
.562 x 1.250

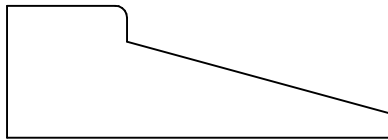

KL 29505
.687 x 2.000

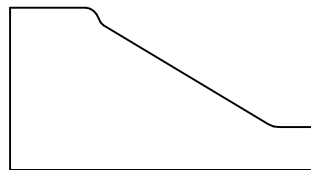

KL 29507
.844 x 1.594

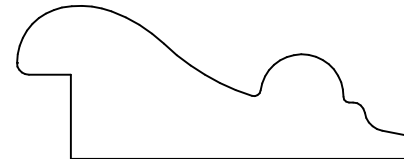

KL 29510
.797 x 2.031

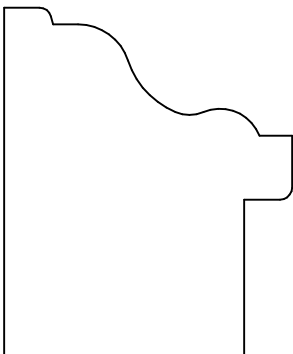

KL 29509
1.812 x 1.500

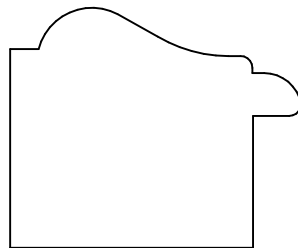

KL 29511
1.250 x 1.516



KL 29512
.871 x 2.062



KL 29514
.456 x .750



KL 29520
.420 x 1.000

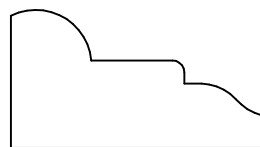

KL 29513
.719 x 1.344



KL 29522
.500 x .500

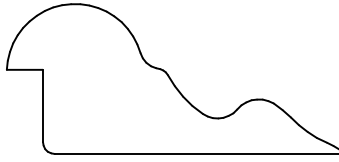

KL 29515
.781 x 1.734

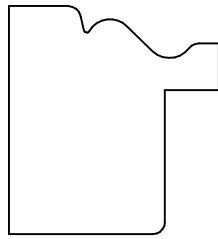

KL 29516
1.188 x 1.094

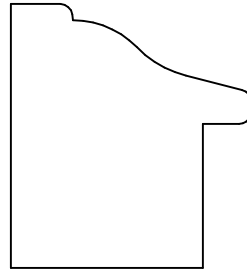

KL 29517
1.375 x 1.250

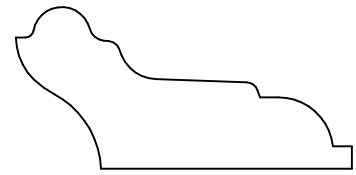

KL 29518
.843 x 1.750

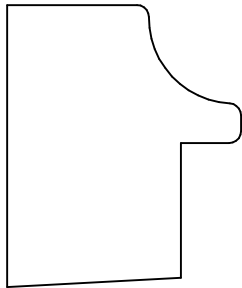

KL 29519
1.468 x 1.219

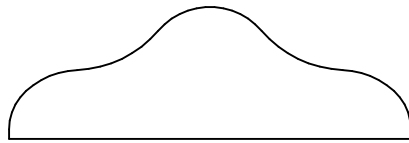

KL 29523
.688 x 2.093



KL 29533
.438 x .750

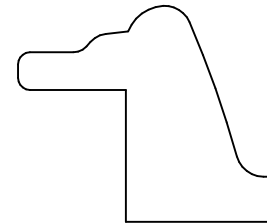

KL 29524
1.125 x 1.250

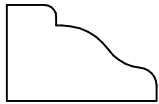

KL 29525
.500 x .779

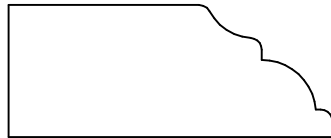

KL 29526
.688 x 1.688

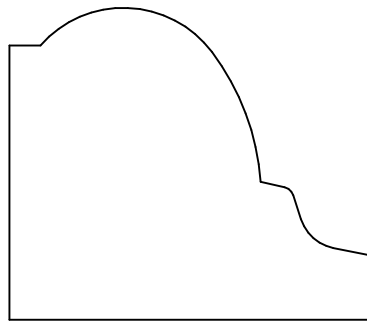

KL 29527
1.625 x 1.906

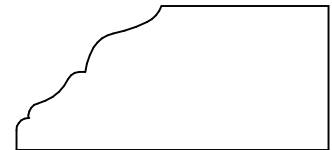

KL 29528
.750 x 1.625

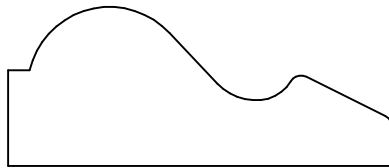

KL 29529
.828 x 2.000

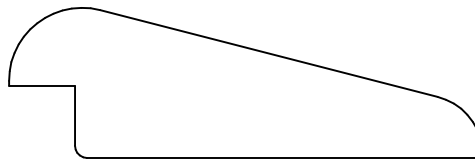

KL 29531
.781 x 2.469

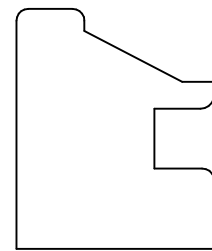

KL 29532
1.250 x 1.031

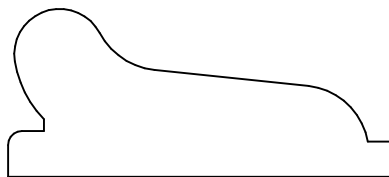

KL 29530
.875 x 2.000



KL 29534
.563 x 1.988

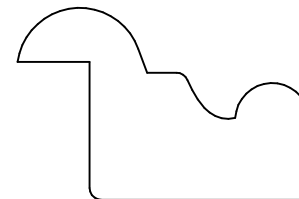

KL 29535
1.000 x 1.500



KL 29540
.688 x .875

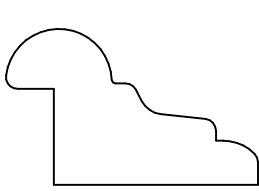

KL 29536
.812 x 1.313

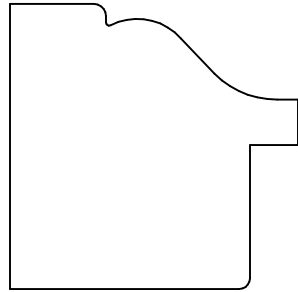

KL 29537
1.484 x 1.500

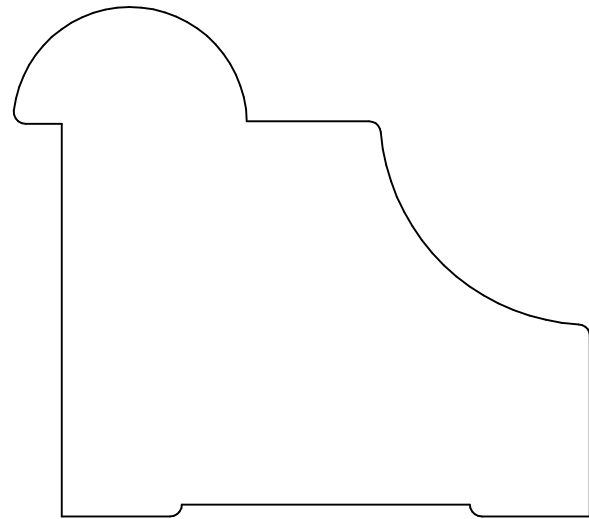

KL 29538
2.654 x 3.000

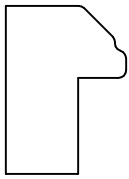

KL 29539
.875 x .625

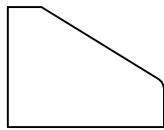

KL 29541
.625 x .813

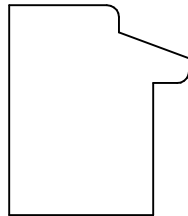

KL 29542
1.094 x .938

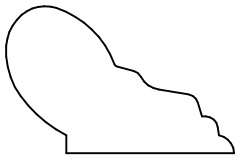

KL 29543
.766 x 1.188

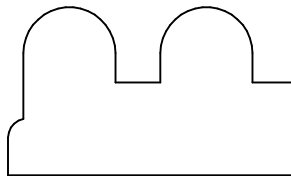

KL 29544
.875 x 1.500

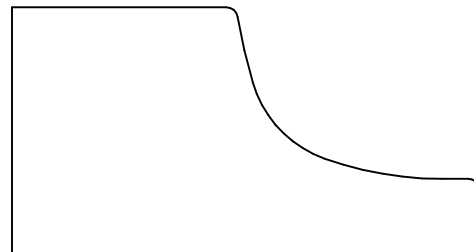

KL 29545
1.281 x 2.438

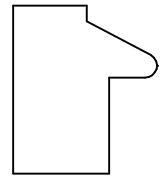

KL 29555
.875 x .750

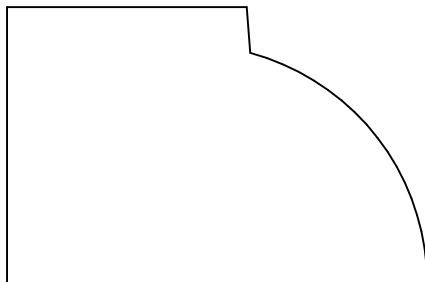

KL 29546
1.438 x 2.188

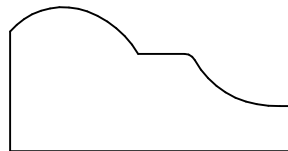

KL 29547
.750 x 1.484



KL 30508
.370 x .359

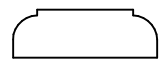

KL 29594
.250 x .750

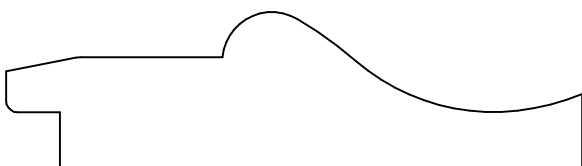

KL 29550
.813 x 3.000

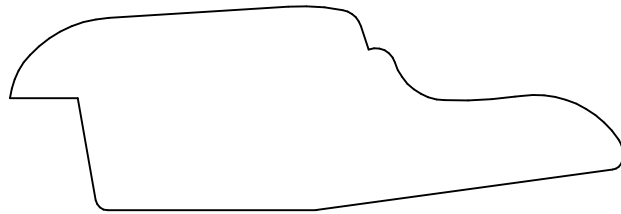

KL 29551
1.062 x 3.193

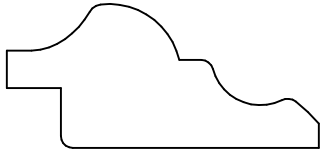

KL 29552
.750 x 1.625

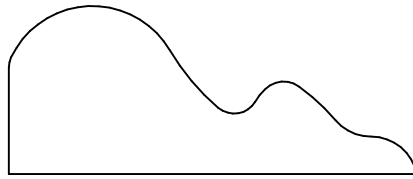

KL 29553
.875 x 2.125

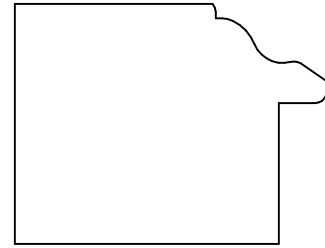

KL 29554
1.250 x 1.625



KL 30523
.438 x .609

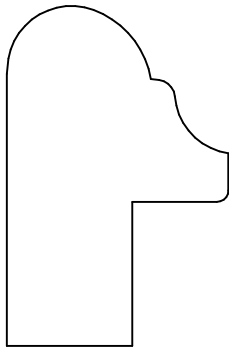

KL 29556
1.770 x 1.153

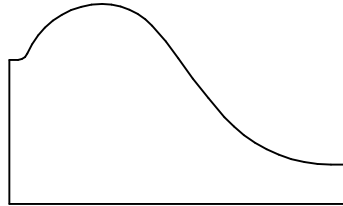

KL 29557
1.041 x 1.750

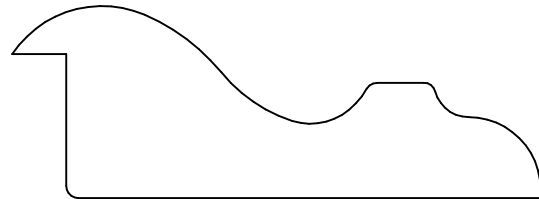

KL 29558
1.000 x 2.750

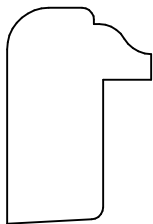

KL 29559
1.125 x .750

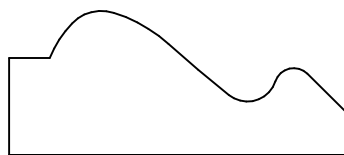

KL 29560
.750 x 1.750

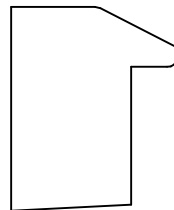

KL 29561
1.062 x .875

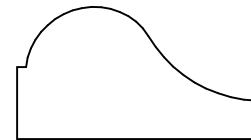

KL 29562
.688 x 1.250



KL 29571
.625 x 1.250

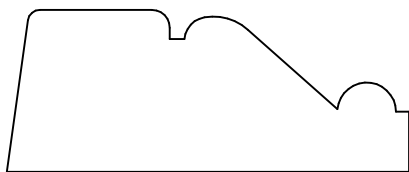

KL 29563
.844 x 2.094

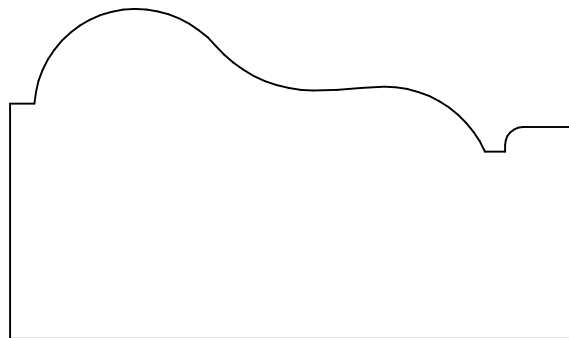

KL 29564
1.719 x 2.956

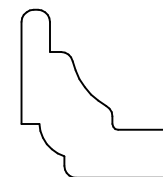

KL 29576
.875 x .750

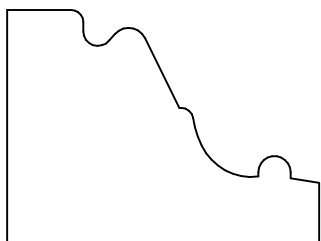

KL 29566
1.219 x 1.625

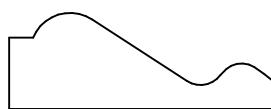

KL 29568
.500 x 1.375

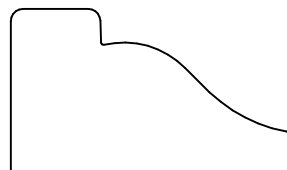

KL 30524
.782 x 1.484

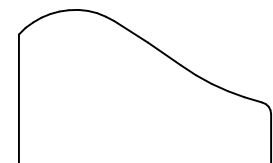

KL 30531
.812 x 1.313

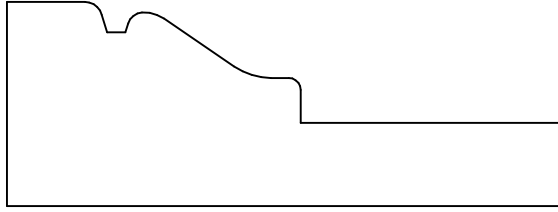

KL 29565
1.063 x 2.875

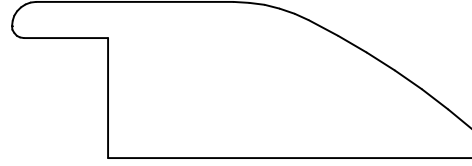

KL 29569
.812 x 2.406

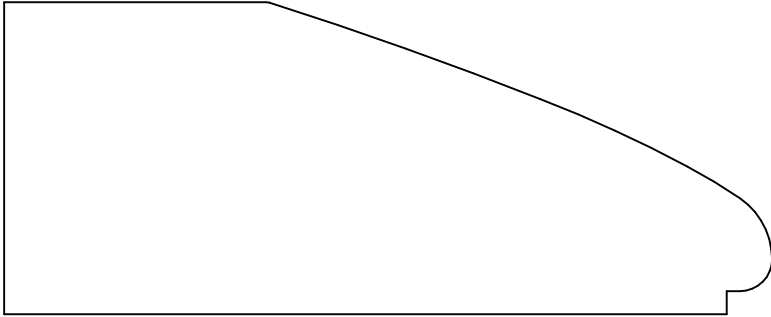

KL 29567
1.625 x 4.000

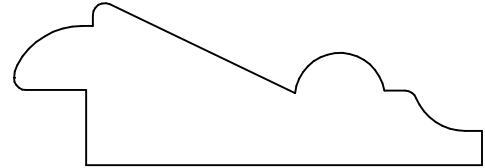

KL 29570
.844 x 2.438

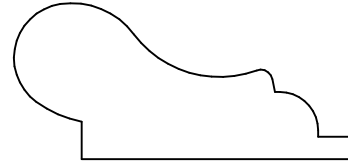

KL 29572
.813 x 1.750

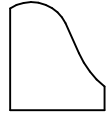

KL 30545
.563 x .492

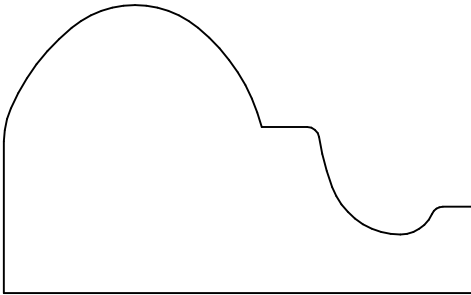

KL 29573
1.500 x 2.438

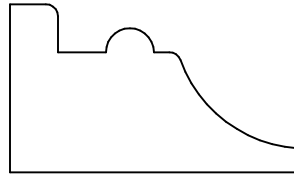

KL 29575
.875 x 1.500

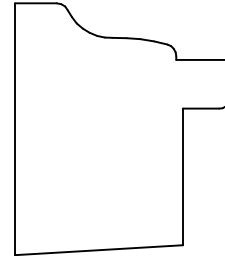

KL 29577
1.313 x 1.125

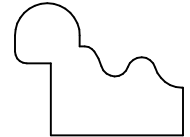

KL 29589
.688 x .875

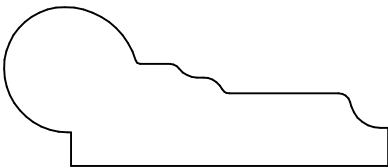

KL 29580
.828 x 2.000

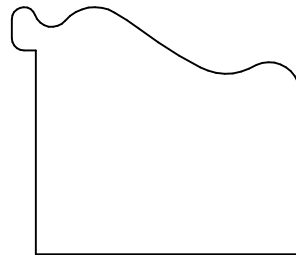

KL 29581
1.287 x 1.500

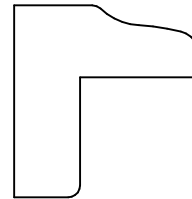

KL 29582
1.000 x .969

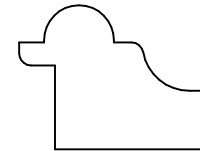

KL 29583
.750 x .969

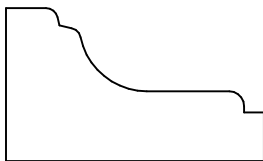

KL 29586
.797 x 1.344



KL 29598
.484 x .723

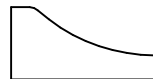

KL 30544
.375 x .750



KL 30550
.375 x .500

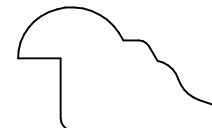

KL 29587
.640 x 1.031

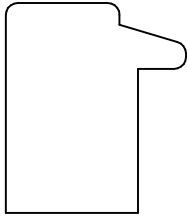

KL 29585
1.094 x .938

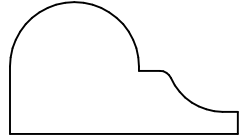

KL 29588
.688 x 1.187

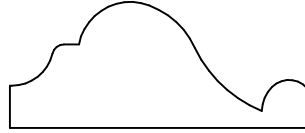

KL 29590
.656 x 1.578

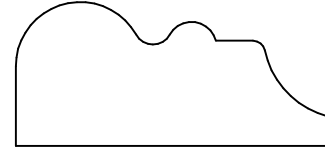

KL 29591
.750 x 1.625

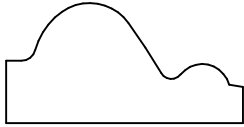

KL 29592
.625 x 1.234

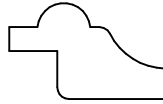

KL 29593
.500 x .813

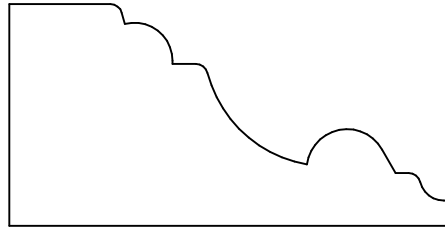

KL 29595
1.156 x 2.313

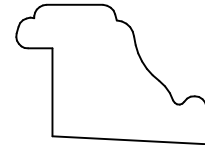

KL 29599
.726 x 1.000

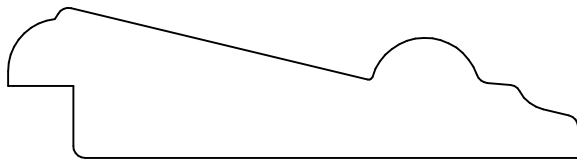

KL 30500
.781 x 2.969

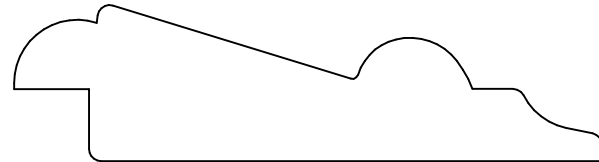

KL 30504
.812 x 3.062

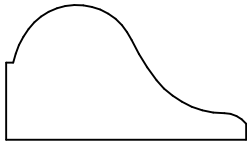

KL 30505
.703 x 1.250

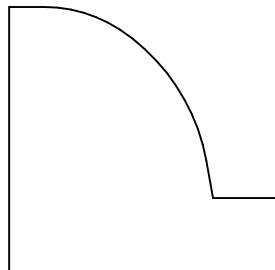

KL 30506
1.375 x 1.406

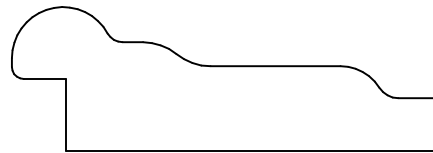

KL 30510
.750 x 2.250



KL 30511
.768 x 1.000



KL 30512
.625 x 2.000

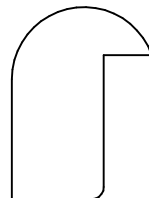

KL 30513
1.000 x .729

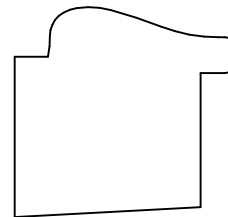

KL 30514
1.094 x 1.156

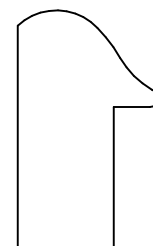

KL 30515
1.234 x .750

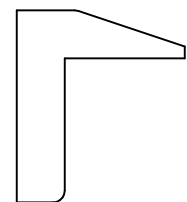

KL 30520
1.000 x .875



KL 30548
.344 x 1.281

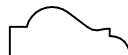

KL 31508
.270 x .625

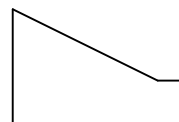

KL 30553
.601 x .902

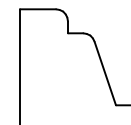

KL 30562
.625 x .625

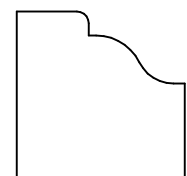

KL 30536
.875 x .875

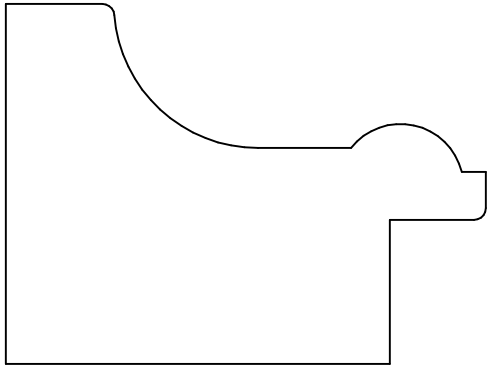

KL 30516
1.875 x 2.500

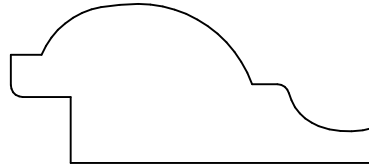

KL 30517
.828 x 1.891

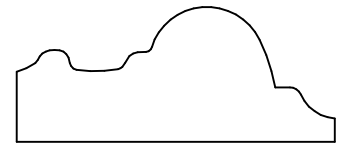

KL 30521
.703 x 1.656

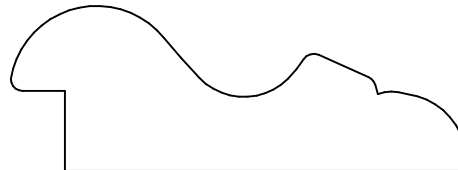

KL 30518
.859 x 2.375

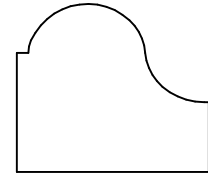

KL 30538
.875 x 1.000

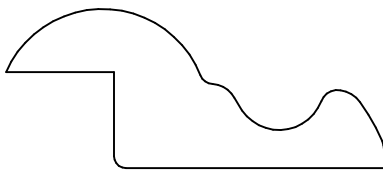

KL 30525
.828 x 1.969

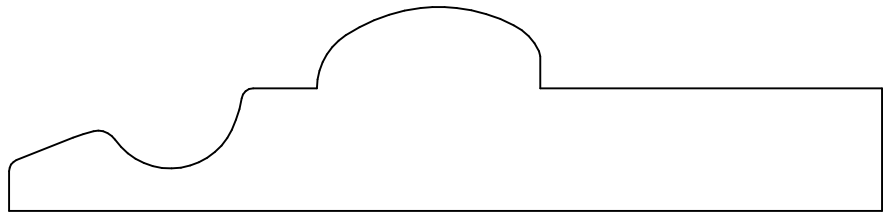

KL 30530
1.062 x 4.547

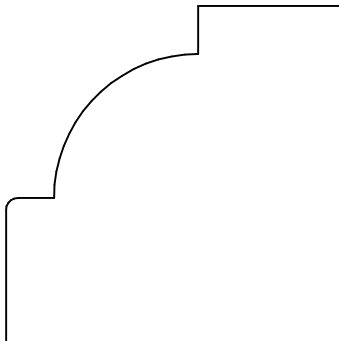

KL 30529
1.750 x 1.750

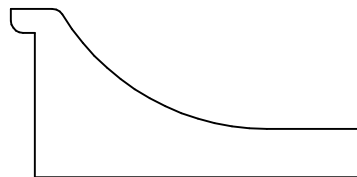

KL 30543
.878 x 1.832

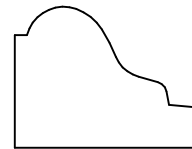

KL 30560
.734 x .969

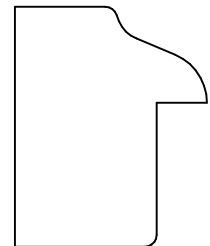

KL 30535
1.250 x 1.000

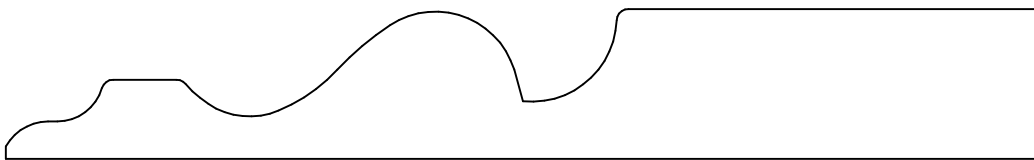

KL 30532
.781 x 5.406

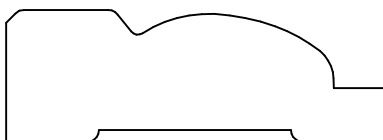

KL 30549
.688 x 1.969

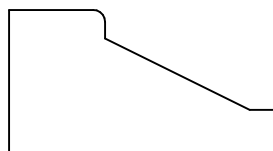

KL 30552
.750 x 1.402

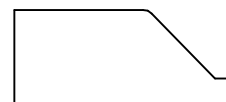

KL 30554
.492 x 1.146

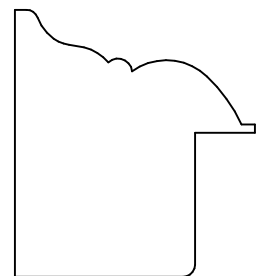

KL 30537
1.391 x 1.250

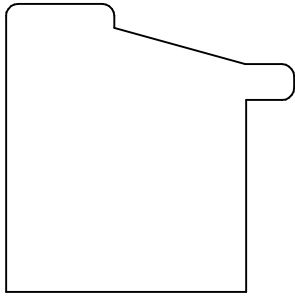

KL 30541
1.500 x 1.500

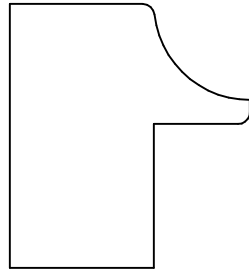

KL 30542
1.375 x 1.250

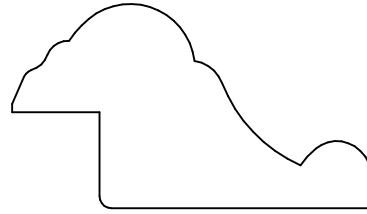

KL 30551
1.063 x 1.875

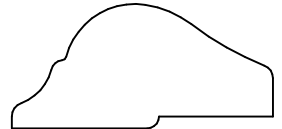

KL 30555
.648 x 1.359



KL 30556
.625 x 1.250

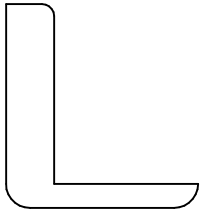

KL 30559
1.062 x 1.000

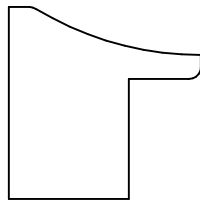

KL 30565
1.000 x 1.000

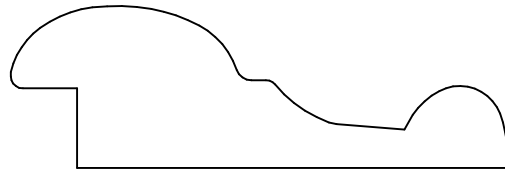

KL 30566
.844 x 2.609

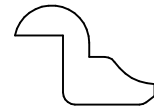

KL 30567
.516 x .727

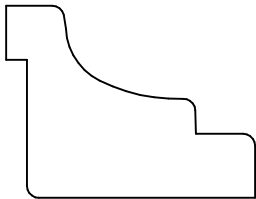

KL 30568
1.000 x 1.297

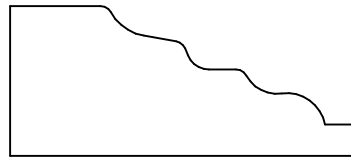

KL 30569
.781 x 1.797

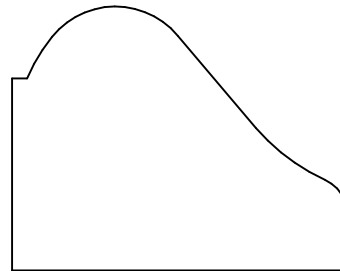

KL 30570
1.375 x 1.750

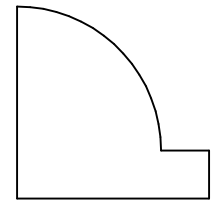

KL 30573
1.000 x 1.000

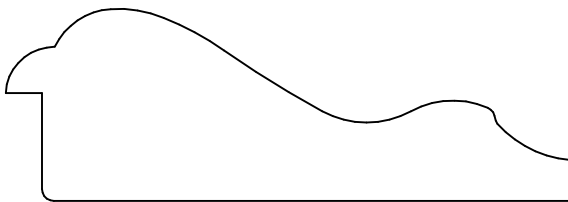

KL 30571
1.000 x 2.937

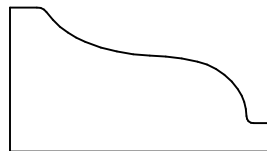

KL 30572
.750 x 1.375

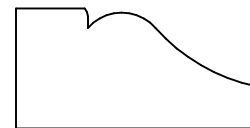

KL 30574
.625 x 1.250

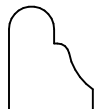

KL 30595
.540 x .438

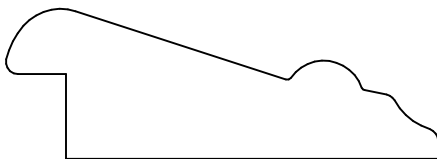

KL 30575
.781 x 2.250

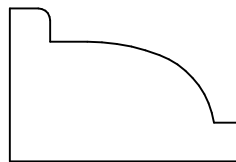

KL 30576
.796 x 1.203

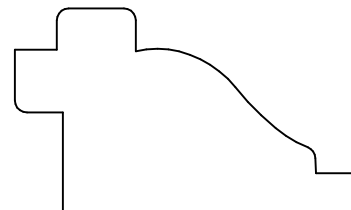

KL 30577
1.062 x 1.797

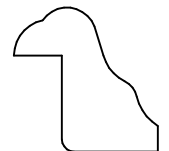

KL 30581
.750 x .750

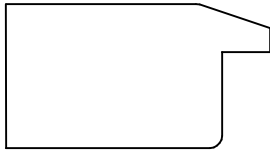

KL 30578
.750 x 1.375

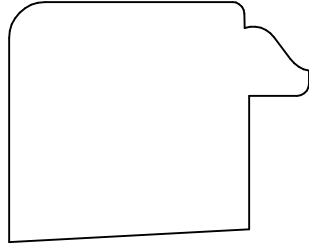

KL 30579
1.250 x 1.563

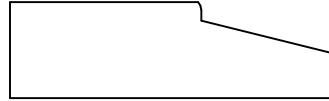

KL 30580
.500 x 1.688

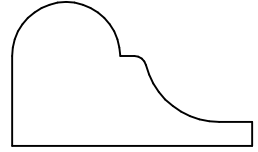

KL 30582
.750 x 1.250

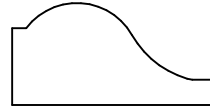

KL 30585
.531 x 1.062

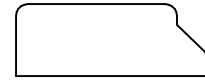

KL 30587
.375 x 1.000

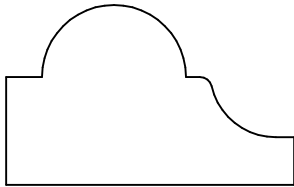

KL 30583
.937 x 1.500



KL 30586
.469 x 1.313



KL 30590
.500 x 1.500

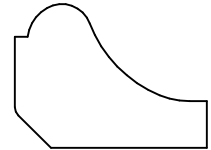

KL 30591
.750 x 1.000

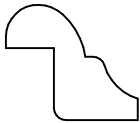

KL 30592
.600 x .687

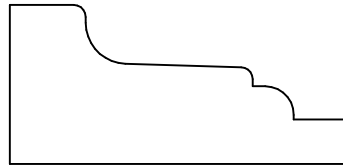

KL 30588
.828 x 1.750



KL 30593
.438 x 1.406

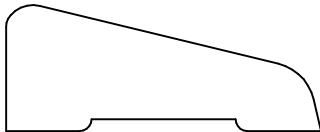

KL 30594
.656 x 1.641

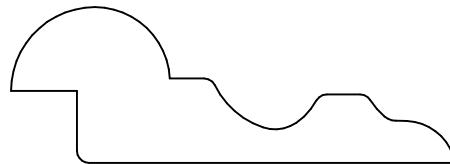

KL 30596
.812 x 2.313



KL 30597
.510 x 1.487



KL 31550
.406 x .500

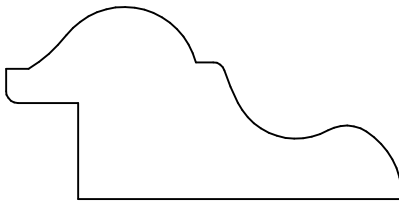

KL 30598
1.000 x 2.062

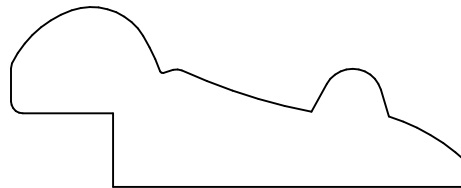

KL 30599
.938 x 2.375

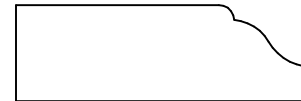

KL 31501
.500 x 1.500

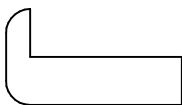

KL 31507
.500 x .915

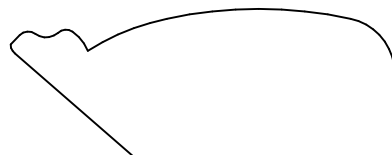

KL 31509
.766 x 2.000



KL 31510
.615 x 1.000

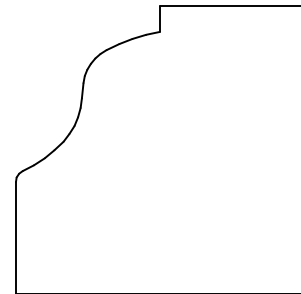

KL 31502
1.500 x 1.500

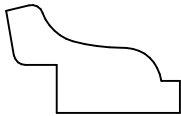

KL 31511
.563 x .906



KL 31512
.500 x .781

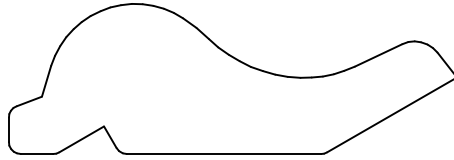

KL 31513
.781 x 2.333



KL 31519
.531 x 1.906

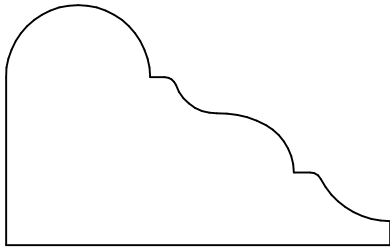

KL 31515
1.250 x 2.000

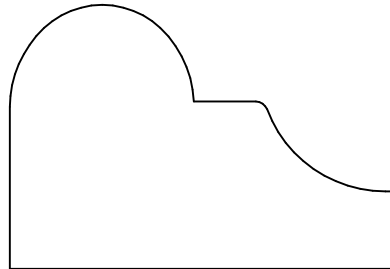

KL 31517
1.375 x 2.000

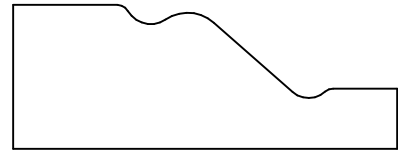

KL 31518
.750 x 2.000

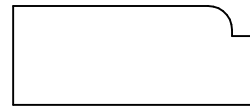

KL 31521
.516 x 1.266

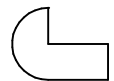

KL 31598
.375 x .500

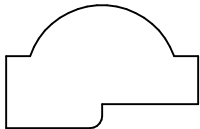

KL 31520
.641 x 1.000

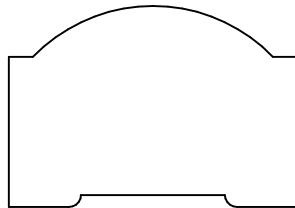

KL 31522
1.047 x 1.500

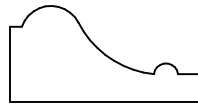

KL 31523
.500 x 1.000

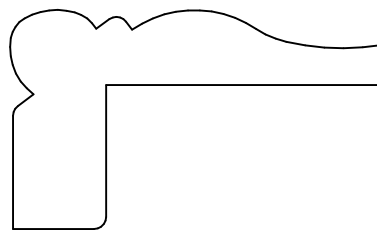

KL 31525
1.141 x 1.938

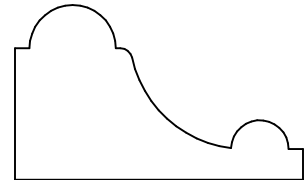

KL 31526
.910 x 1.500



KL 31527
.500 x 1.750

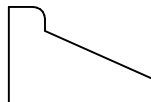

KL 31554
.500 x .750



KL 31532
.375 x 1.000

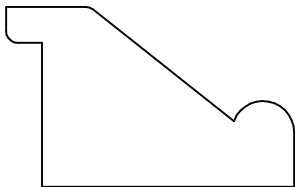

KL 31528
.937 x 1.500

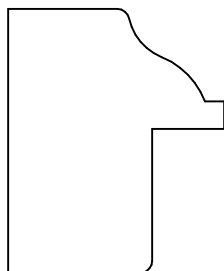

KL 31530
1.375 x 1.125

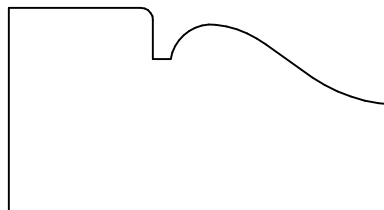

KL 31531
1.062 x 2.000



KL 31536
.391 x 1.063

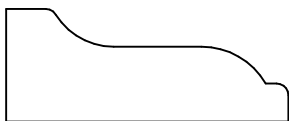

KL 31533
.587 x 1.471

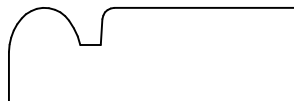

KL 31540
.500 x 1.516

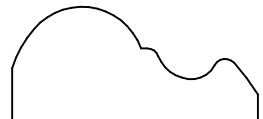

KL 31556
.594 x 1.281

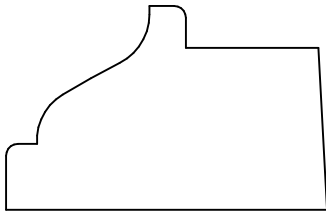

KL 31534
1.062 x 1.672

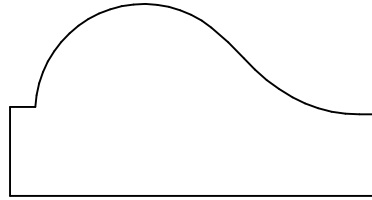

KL 31537
1.000 x 1.906

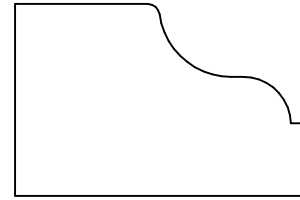

KL 31539
1.000 x 1.500

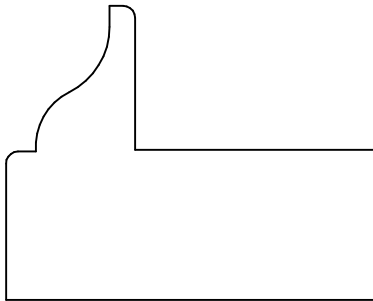

KL 31541
1.531 x 1.922



KL 31542
.531 x 1.547

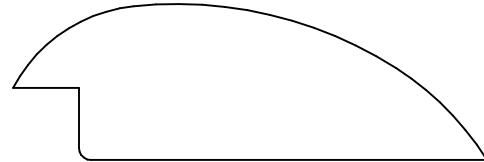

KL 31543
.813 x 2.469

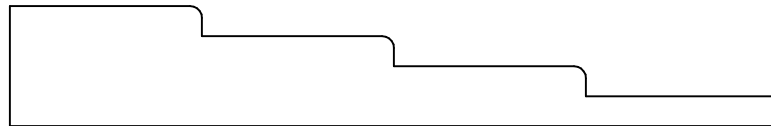

KL 31544
.625 x 4.000

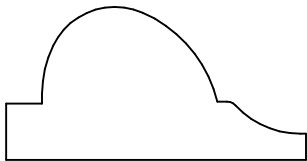

KL 31545
.797 x 1.563

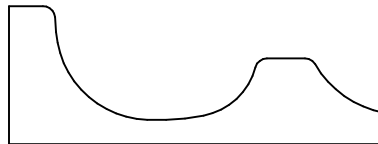

KL 31546
.719 x 1.953

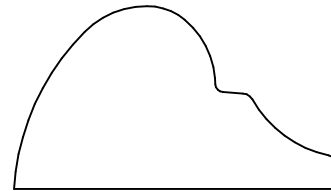

KL 31547
.953 x 1.688

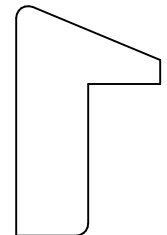

KL 31551
1.195 x .750

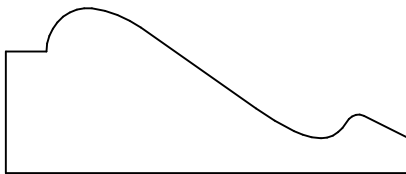

KL 31548
.859 x 2.094

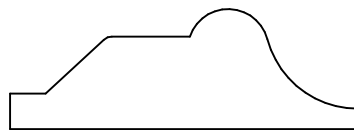

KL 31549
.625 x 1.812

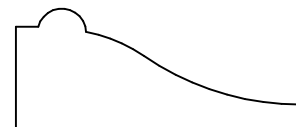

KL 31552
.625 x 1.500

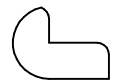

KL 33525
.371 x .499

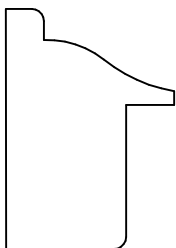

KL 31553
1.250 x .875

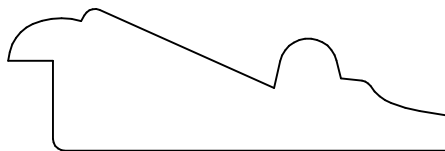

KL 31555
.738 x 2.297

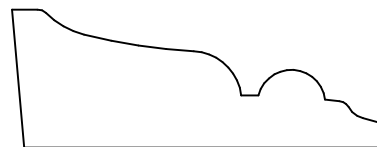

KL 31557
.719 x 1.875



KL 31564
.500 x .844

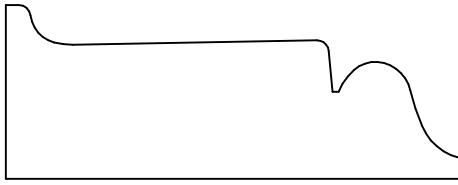

KL 31558
.906 x 2.359

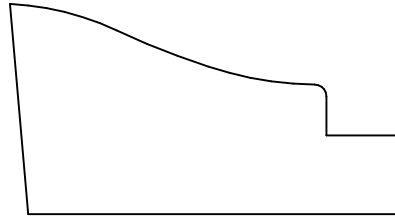

KL 31559
1.094 x 2.031

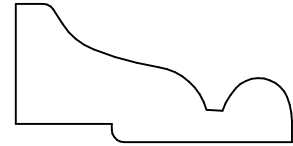

KL 31560
.719 x 1.438

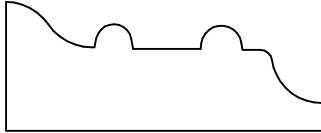

KL 31561
.672 x 1.652

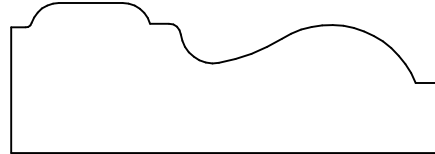

KL 31563
.781 x 2.250

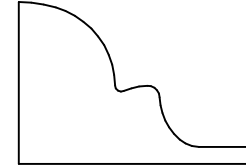

KL 31567
.844 x 1.188

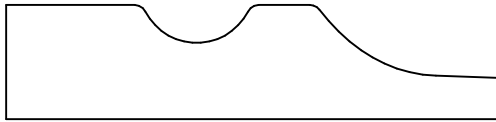

KL 31565
.594 x 2.563

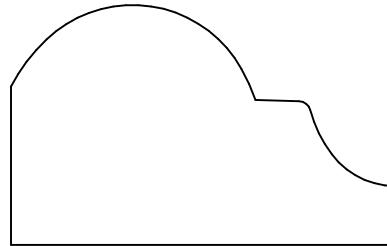

KL 31568
1.250 x 2.000

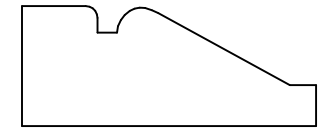

KL 31569
.625 x 1.531

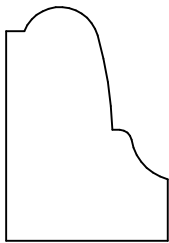

KL 31570
1.218 x .843

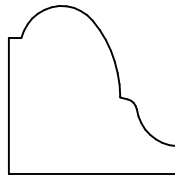

KL 31571
.875 x .875

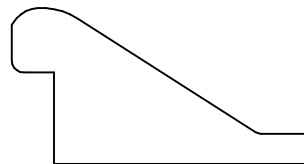

KL 31578
.812 x 1.547



KL 31575
.375 x 1.000

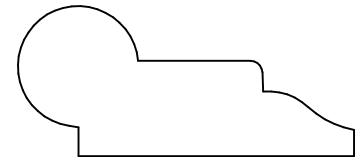

KL 31579
.781 x 1.750

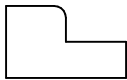

KL 33501
.375 x .625

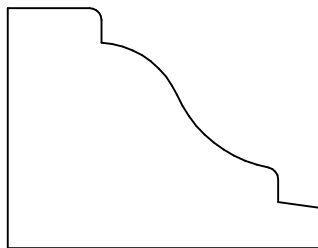

KL 31577
1.250 x 1.625

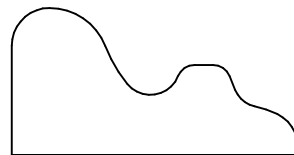

KL 31582
.766 x 1.500

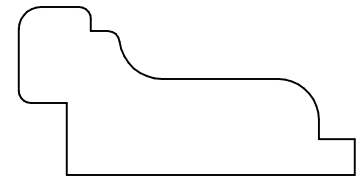

KL 31583
.875 x 1.750

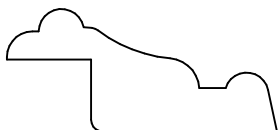

KL 31584
.638 x 1.407



KL 31586
.500 x 1.750

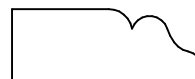

KL 31594
.375 x 1.000

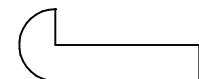

KL 31597
.375 x .938

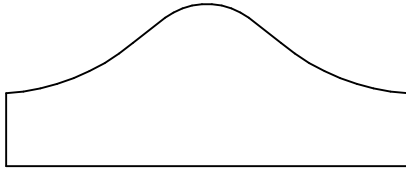

KL 31585
.844 x 2.093



KL 31587
.556 x 1.218

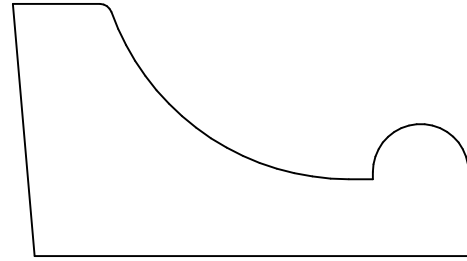

KL 31588
1.313 x 2.375



KL 31589
.484 x 1.031

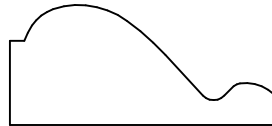

KL 31590
.625 x 1.375

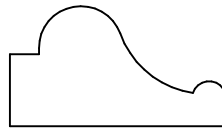

KL 31593
.625 x 1.125

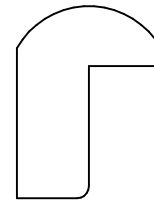

KL 31596
1.000 x .750

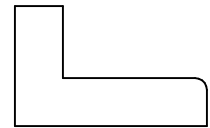

KL 31599
.625 x 1.000

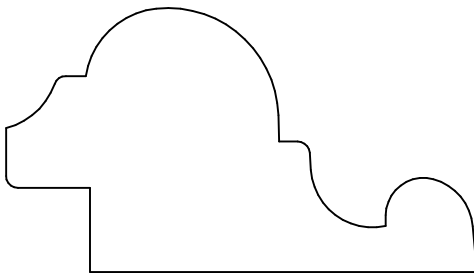

KL 31595
1.375 x 2.453

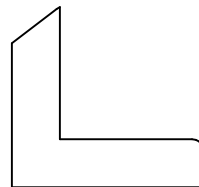

KL 33500
.938 x 1.000

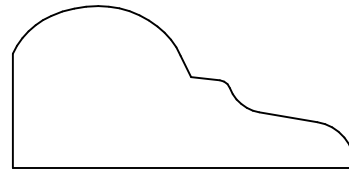

KL 33502
.844 x 1.781



KL 33523
.375 x .625

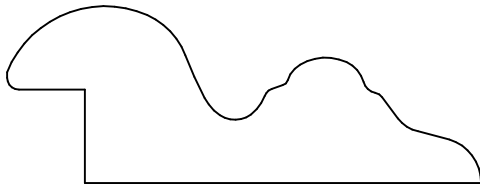

KL 33504
.922 x 2.469

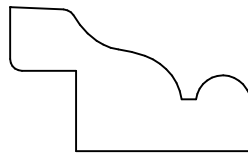

KL 33505
.750 x 1.266

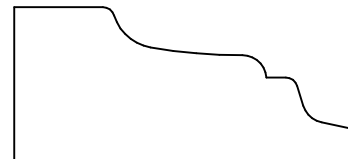

KL 33506
.797 x 1.750

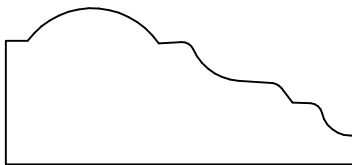

KL 33507
.813 x 1.812

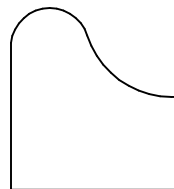

KL 33508
.946 x .875



KL 33509
.375 x 1.500

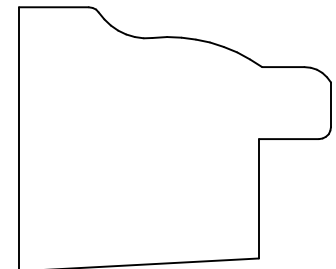

KL 33510
1.375 x 1.625



KL 33511
.625 x 1.250

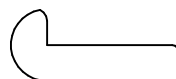

KL 33522
.371 x .868

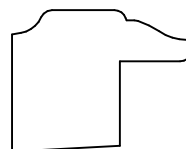

KL 33512
.736 x .938

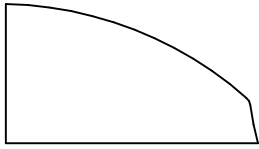

KL 33513
.725 x 1.313

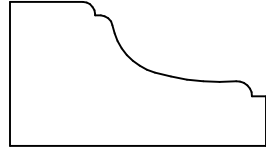

KL 33514
.750 x 1.333

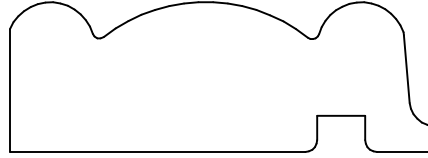

KL 33515
.781 x 2.219

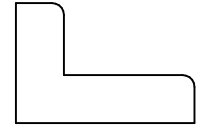

KL 33524
.625 x .930

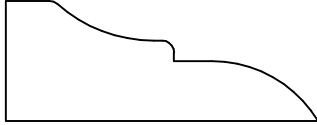

KL 33516
.625 x 1.625

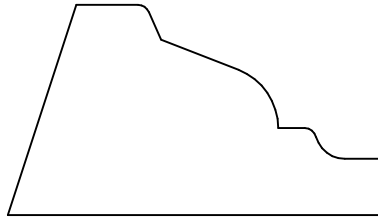

KL 33517
1.094 x 1.953

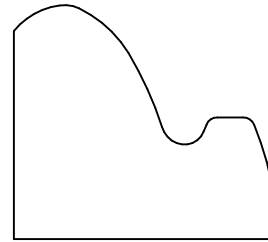

KL 33520
1.219 x 1.375

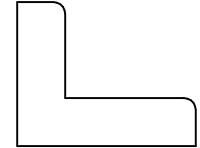

KL 33526
.750 x .930

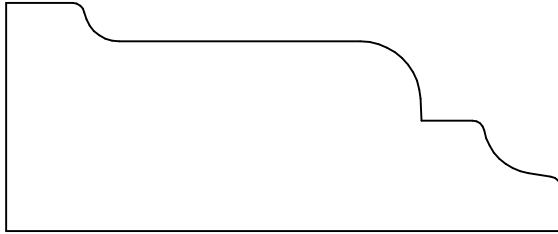

KL 33518
1.188 x 2.891

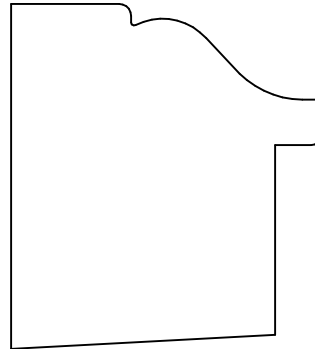

KL 33527
1.796 x 1.625

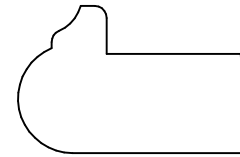

KL 33532
.766 x 1.187

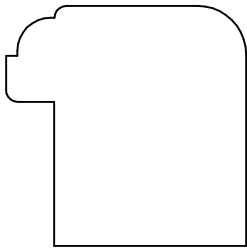

KL 33533
1.250 x 1.250

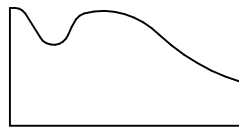

KL 33534
.614 x 1.203

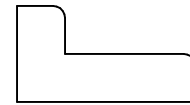

KL 33535
.500 x .930

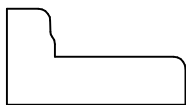

KL 33545
.500 x .930

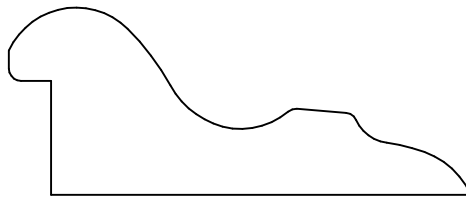

KL 33537
.975 x 2.406

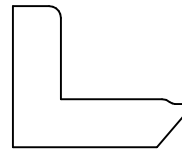

KL 33541
.735 x .938

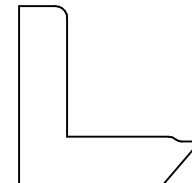

KL 33542
.930 x .938

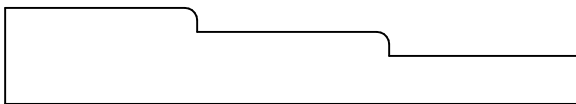

KL 33550
.500 x 3.000

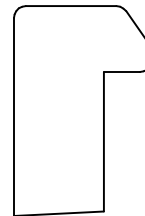

KL 33548
1.094 x .719

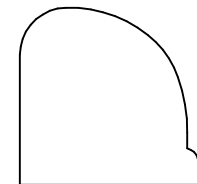

KL 33551
.922 x .953

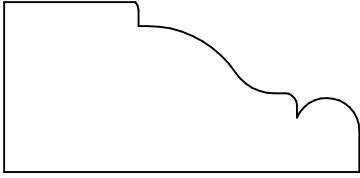

KL 33549
.885 x 1.850

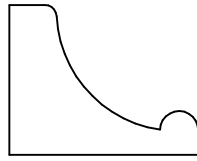

KL 33552
.781 x .984

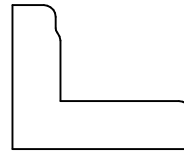

KL 33553
.750 x .930

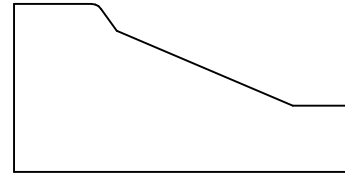

KL 33554
.875 x 1.734

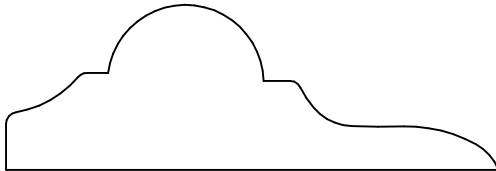

KL 33555
.859 x 2.563

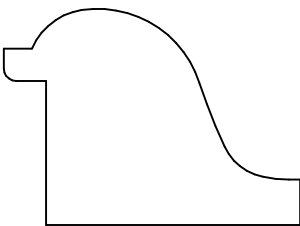

KL 33560
1.125 x 1.542



KL 33557
.359 x .734

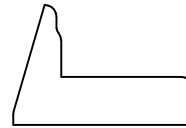

KL 33558
.625 x .938

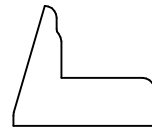

KL 33559
.625 x .735

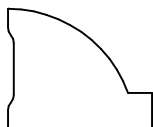

KL 33563
.625 x .750

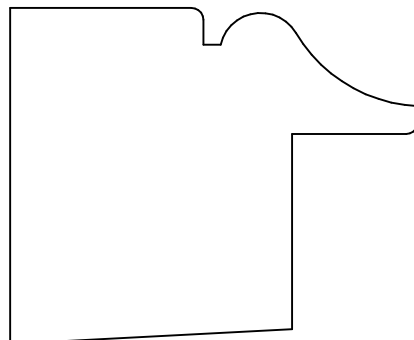

KL 33561
1.750 x 2.125

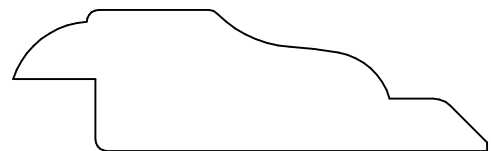

KL 33562
.734 x 2.469



KL 33564
.750 x 2.000